



PARAMOUNT SURGICAL TRADING CO.

Manufacturers of Surgical, Dental & Manicure Instruments

MEDICAL SURGICAL & HOLLOWWARE CATALOGUE





CERTIFICATE

Certificate no. 4717

PARAMOUNT SURGICAL TRADING CO.

Air Port Road, Gohad Pur,
Sialkot-51360-Pakistan

QS Zürich AG certifies that the management system of the above mentioned company has been assessed and meets the requirements established by the following rules:

ISO 9001: 2008

The management system includes:

**MANUFACTURE AND EXPORT OF SURGICAL, DENTAL,
VETERINARY INSTRUMENTS, MANICURE/PEDICURE
IMPLEMENTS AND SCISSORS OF ALL SORTS.**

EA Sector 19

In the course of the validity of the present certificate the enterprise management system must permanently satisfy the requirements of the international regulations. The fulfilment of these regulations will be regularly controlled by QS Zürich AG.

For precise and updated information concerning possible changes occurred in the certification object of the present certificate, please contact info@qs-certification.com



First certification date: 29.12.2008
New issue date: 13.03.2013
Expiration date: 23.02.2014

QS Zürich AG
P.O. Box 8335
CH-8050 Zürich
qs-zuerich@quality-service.ch



SCE5m 947
www.ses.ch

Director

Your reliable Partner for
CE Marking /
Product Certifications.



Blue Star Company
Conformity and Compliance

EC DECLARATION OF CONFORMITY FOR CE MARKING

No. 254402-2013

We, Blue Star Company, 40-Thorncliffe Road, Norwood Green, Southall Middx London UB2 5RQ, United Kingdom being an Authorized Representative in the Community for

Paramount Surgical Trading Co.
Airport Road, Gohad Pur, Sialkot-Pakistan.

Declares and certifies that the above mentioned manufacturer:

- 1) has drawn EC Declaration of Conformity in compliance with Annex-VII of Council Directive 93/42/EEC.
- 2) has established and maintaining technical documentation of class -I Surgical & Dental Instruments in compliance with Annex-VII of Council Directive 93/42/EEC.
- 3) has designated their Authorized Representative in the European Community in compliance with Article 14(2) of Council Directive 93/42/EEC.

and consequently they can affix CE marking on their:

- a) Class-I Surgical Instruments
- b) Class-I Dental Instruments

Date of issuance: March 13, 2013
Valid till: February 23, 2014

Authorized Signature



Registered with Competent Authority in UK, Medicines and Healthcare Products Regulatory Agency, UK, MHRA under Medical Devices Regulation 2002/Regulation 19/Council Directive 93/42/EEC for representing foreign manufacturers for placing medical devices on the market.

40-Thorncliffe Road, Norwood Green, Southall Middx London UB2 5RQ UK.
Tel: 00 44 (0) 208 843 1607, Fax: 00 44 (0) 208 843 1609, E-Mail: info@bluestarce.com, ukbluestar@hotmail.com
Web: www.bluestarce.com

Safeguarding public health

Our Ref: CA004542

Mr D Iqbal,
Blue Star Company
40 Thorncliffe Road
Norwood Green
Southall
Middlesex
UB2 5RQ
UK

10 June 2010

Dear Mr Iqbal,

MHRA

MEDICAL DEVICES REGULATIONS 2002: REGULATION 19 Registration of Persons Placing General Medical Devices on the Market

Thank you for informing the Competent Authority of the change to the original notification dated (date the registration was registered); **Manufacturers Name: Paramount Surgical Trading Co.**, located at **Manufacturers Address: Air Port Road Gohad Pur Sialkot Pakistan 51360** for whom you are acting as the authorised representative and for supplying the medical device information.

The change(s) to your registration has been recorded based on your declaration that you have determined that the device(s) fall within the definition of "medical device", and that you have classified it/them as falling within Regulation 19 taking into account the intended purpose(s) and mode(s) of action. In accepting your registration, I should make clear that the Competent Authority does not examine each individual notification and therefore cannot and does not necessarily endorse these determinations. Neither does this letter represent any form of accreditation or approval by the UK Competent Authority.

Your registration is based upon your declaration on the RG2 form and means that:

For Manufacturers of Class I medical devices, Assemblers, and Sterilisers

You should now be operating under the Medical Devices Directive and the above Regulations for the products you asked us to register, by fully complying with the essential requirements, CE marking those products or labelling them as such.

For Manufacturers of Custom-made devices

You should be ready to claim compliance with the Directive and Regulations and should be manufacturing custom-made devices in accordance with their requirements.

If you stop placing devices on the market or if you are not complying with the Regulations you should inform us so that we can amend our records. You should be aware that it is an offence to place on the market CE marked devices that do not comply with the Regulations.

The information you provided has been recorded against the reference number shown at the top of this letter, which we ask you to quote in all future correspondence and communications.

Please inform us of any changes to:

- the company information
- additional generic groups of devices (not individual products within an existing generic group)
- discontinuation of a generic group of devices.

Please use RG2, the Registration form, to tell us about any of these changes.

Medicines and Healthcare products Regulatory Agency
Market Towers, 1 Nine Elms Lane, London SW9 5NQ
T 020 7084 2000, F 020 7084 2353 www.mhra.gov.uk
ConfRep Vers 2 Sept 2008

An executive agency of the Department of Health

Thank you for registering the following generic groups of devices:

Class I Devices:

Dental Instruments (Re-Usable & Non-Powered)
Surgical Instruments (Re-Usable And Non-Powered)
Measuring and mixing devices for medicines
Syringes (Hypodermic/Oral/Irrigation)
Handheld Dental Mirrors And Accessories
Impression Materials, Trays And Adhesives / Bite Wafers / Bite Gauge
Stethoscopes
Laryngoscopes/Otoscopes And Accessories
Ophthalmoscopes/Retinascopes
Umbilical Clamps/Tape

Custom Made Devices:

None

Products Covered By Article 12:

None

Confidentiality

Please note that in accordance with Directive 2007/47/EC as of 21st March 2010 information on the registration of persons responsible for placing devices on the market will no longer be treated as confidential and the Competent Authority will provide third parties with information on the name and address of manufacturers and authorised representatives and their devices that have been registered. However the names of individuals, their telephone numbers and email addresses will remain confidential unless you have chosen to trade using personal details. This change only applies to medical devices and does not affect In Vitro Diagnostic devices registration, which remain confidentiality under Article 19 of the In Vitro Diagnostic Directive 98/79/EC.

If your company name or that of a manufacturer that you represent is based on an individual's personal name it will be published unless you inform the MHRA that you would like the company name to remain confidential.

Likewise, if your company address or that of a manufacturer that you represent is the personal home address of an individual it will be published unless you inform the MHRA that you would like the company address to remain confidential.

Should you have any queries regarding your registration, please do not hesitate to contact us.

Yours sincerely

Barbara Clarke

Regulatory Affairs Administrator

Tel: 020 7084 3195

Fax: 020 7084 3112

Email: barbara.clarke@mhra.gov.uk

ConfRep Vers 2 Sept 2008

Dear Customer

Please spare few minutes and read our request, may be you find a good supplier and we find a good buyer.

We are the leader manufacturers cum exporter. All our products are manufacturing under strict supervision of skilled workers using best steel.

We are specialist of many items but as such you have not seen our products earlier, really you will feel happy to see our instruments.

We assure you of our best services at all the times with the supply of good quality instruments as per your entire satisfactions.

With many regards.

SHAKEEL AHMED
Director

Welcome

MEMBERS:

Sialkot Chamber of
Commerce & Industry

The Surgical Instruments
Manufacturers Association of Pakistan.



Founder : **Al-Haj M. Munir (Late)**



Director: **Shakeel Ahmed**

INTRODUCTION

We have the best quality instruments

Dear Customers,

We are happy to present our New Catalogue of Surgical Instruments. We have improved in order to make it simpler and easier to follow. It would be an excellent guide to all our customers in the world over.

Since 1975

We are manufacturer of wide range Stainless Steel and Brass Chrome plated instruments. Quality of our each instrument is made to exact specifications. Much of our time is spent assuring the quality of the products we sell. Our name does not go on any instrument that fails to pass our tough quality assurance standards. We know our reputation depends on providing a quality product that will perform constantly for years.

The selection of instruments has been increased because of the wide acceptance of these instruments of our customers. We have been produced by experienced and skilled master craftman in ourworkshops in the area of Sialkot.

It is due to their efficient cooperation and superior workmanship that we have made itself a name throughout the world as a reliable supplier of high quality of Surgical, Dental, Manicure, Pedicure & Veterinary instruments.

SPECIAL INSTRUMENTS: We also welcome your enquires for the instruments not listed in this catalogue and can be made to order and customers ideas carefully carried out by skilled technicians in our workshops.

We invite you contact us for all your instruments which you needs. There's no better choice when you want the best. We provide you better quality and selection.

A Company of Al-Haj M.Munir Son.

Quality of Instruments

1. Premier craftman ship.
2. Highest quality standard of workmanship.
3. Our instruments are made of high Quality,
Durable surgical grade stainless steel

Our Products

The Company offers a broad range of products through its specialized catalogues. In addition to the instruments mentioned in the catalog, PARAMOUNT SURGICAL CO. is also capable of producing other instruments upon specification or reference to other catalogs. Surgical Instruments are made using a variety of stainless steel or chrome plated brass depending upon the requirements of the customers. Strips, Coils, Round bar, and Pipes are used for manufacturing the surgical instruments and the following types of stainless steel is used depending upon request.

Japaness Stainless steel
French Stainless steel
German Stainless steel
Italion Stainless steel
Pakistan Stainless steel

New Product Offerings:

PARAMOUNT SURGICAL CO. Continuously adds latest product / instruments to its catalog and production line. Any latest instruments can be produced based on drawing or sample. Super cut, TC Super cut, Razor edge, titanium and micro instruments are examples of some products which represent the latest in healthcare instrumentation and are currently offered by the company.

PARAMOUNT SURGICAL Quality Guarantee:

Each instrument of PARAMOUNT SURGICAL CO. is guaranteed against rust, breakage or mechanical complication to be either repair or replace free of cost.

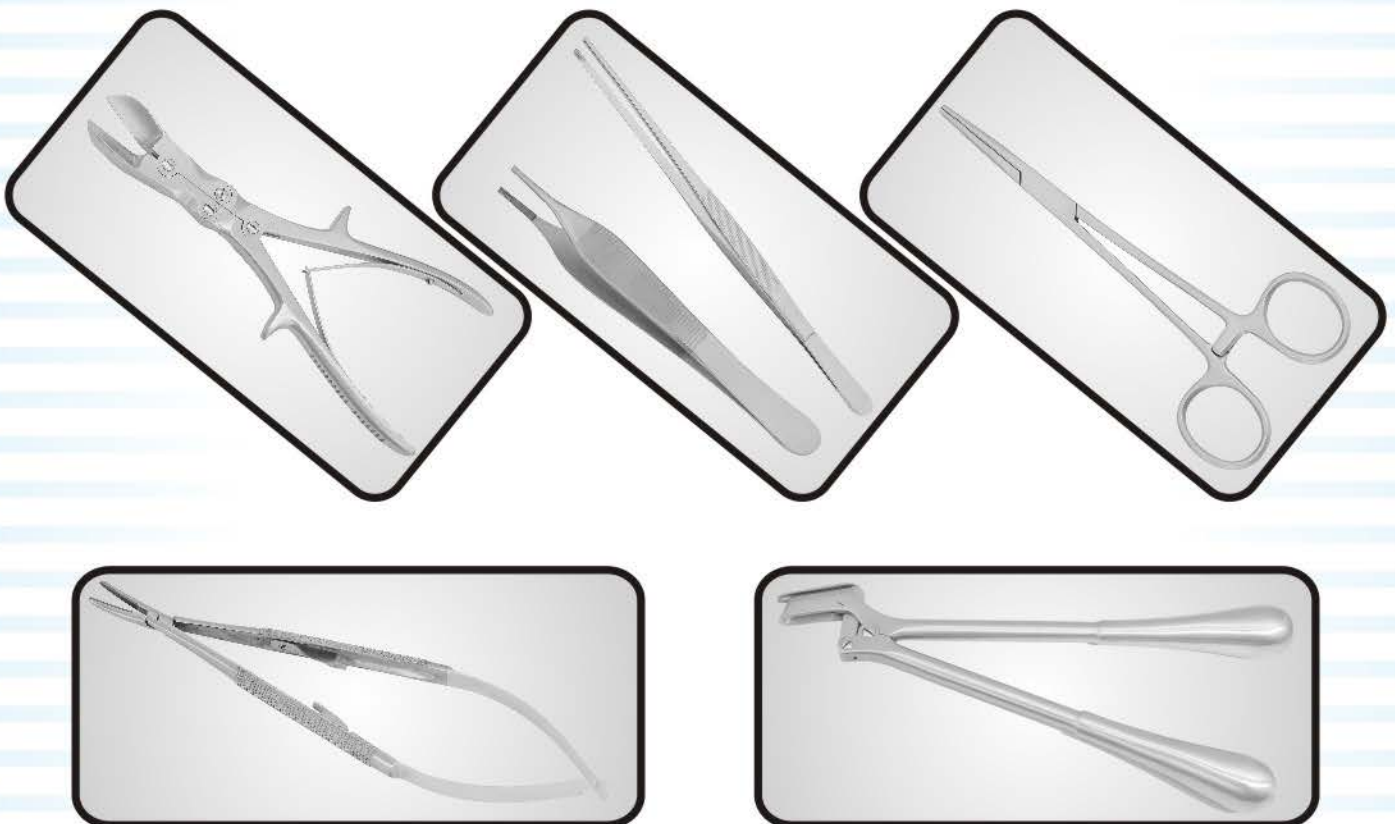



Table of Contents

PST 01	Skalpelle Scalpels Bisturies Bistouris Bisturi	PAGE NO:	01 - 05	PST 02	Scheren Scissors Tijeras Ciseaux Forbic	PAGE NO:	06 - 25
PST 03	Pinzetten Forceps Pinzas Pinces Pinze	PAGE NO:	26 - 34	PST 04	Arterienklemmen Artery Forceps Pinzas Hemostaticas Pinces Hemostatiques Pinze emostatiche	PAGE NO:	35 - 48
PST 05	Tupfer and kornzeggen Cotton Swep Forceps etc Pinzas Para tapones y- curaciones Pinces Tampons et à Pansements Pinze per Tamponi e per Medicazione	PAGE NO:	49 - 50	PST 06	Wundhaken Retractors Separadores Ecarteurs Divaricatori	PAGE NO:	51 - 72
PST 07	Sonden Watteträger Spatel Probes, Applicators, Spatulas Sondas, Porta-algodones, Espátulas Sondes, Porte-Cotons, Spatules Sonde, Portacotoni, Spatole	PAGE NO:	73	PST 08	Diagnostik Diagnostics Diagnóstico Diagnostic Diagnostica	PAGE NO:	74 - 76
PST 09	Trokare, Saugar, Kanülen Trocars, Suction Tubes, Cannulas Trócares, Tubos de Aspiración, Cánulas Trocarts, Tubes d'aspiration, Canules Trequarti, Tubi d'aspirazione, Cannule	PAGE NO:	77 - 79	PST 10	Narkose Anaesthesia Anestesia Anesthésie Anestesia	PAGE NO:	80



Table of Contants

PST 11	Naht Suture Sutura Suture Sutura	PAGE NO:	81 - 92	PST 12	Verband Dressings Vendajes Pansements Bendaggi	PAGE NO:	93 - 94
PST 13	Knochenchirurgie Bone Surgery Cirugía ósea Chirurgie osseusa Chirurgie ossea	PAGE NO:	95 - 98	PST 14	Knochenchirurgie Bone Surgery Cirugía ósea Chirurgie osseusa Chirurgie ossea	PAGE NO:	99 - 119
PST 15	Herz-und Gefäßchirurgie Cardiovascular Surgery Cirugia Cardiovascular Chirurgie Cardio-vasculaire Chirurgia Cardiovascolare	PAGE NO:	120 - 139	PST 16	Neurochirurgie Laminektomie Neurosurgery, Laminectomy Neurocirugia, Laminectomia Neurochirurgie, Laminectomie Neurochirurgia, Laminectomia	PAGE NO:	140 - 145
PST 17	Tracheotomie Tracheotomy Traqueotomía Trachéotomie Trachéotomia	PAGE NO:	146	PST 18	Dermatologie Dermatology Dermatología Dermatologie Dermatologia	PAGE NO:	147
PST 19	Magen,Darm Rektum Stomach,intestines,Rectum Estómago,intestinos,Recto Estomac,intestins,Rectum Stomaco,intestini,Retto	PAGE NO:	148 - 154	PST 20	Urologie Urology Urología Urologie Urologia	PAGE NO:	155 - 158



Table of Contents

PST 21	Gynäkologie Gynecology Ginecología Gynécologia Ginecologia	PST 22	Geburtshilfe Obstetrics Obstetricia Obstétrique Ostetricia
PAGE NO:	159 - 166	PAGE NO:	167
PST 23	Messzirket Campares Compases Compass Compassi	PST 24	Otologie Otology Otología Otologie Otologia
PAGE NO:	168	PAGE NO:	169 - 176
PST 25	Rhinologie Rhinologie Rinología Rhinologia Rinologia	PST 26	Mund-,Kiefer- Gesichtschirurgie Oral Maxillo-Facial Surgery Cirugía oral y maxilofacial Chirurgie buccale et maxillo-faciale Chirurgia buccale e maxillo-faciale
PAGE NO:	177 - 185	PAGE NO:	186 - 197
PST 27	Tonsillektomie, Laryngo Bronchoskopie Tonsillectomy Laryngo-Bronchoscopy Tonsilectomia Laringo-Bronchoscopia Tonsillectomie Laryngo-Bronchoscopie Tonsilectomia Laringo-Bronchoscopia	PST 28	Kranio-Maxillofaziale Chirurgie Cranic-Maxillo-Facial Surgery Cirugia craneo-maxilofacial Chirurge ou crane et maxillo-faciale Chirurgia cranio- maxillo-facciale
PAGE NO:	198 - 200	PAGE NO:	201 - 208
PST 29	Hygiene, Aufbewahrung Hygiene, Storage Higiene, Almacenaje Hygiene, Stockage Igiene, Magazzinaggio	PST 30	Gefäße aus Edelstahl Stainless Steel Receptacles Recipientes de acero inoxidable Récipients en acier inoxydable Recipienti di acciaio inossidabile
PAGE NO:	209- 210	PAGE NO:	211 - 212



Table of Contents

PST 31	Verschiedenes Miscellaneous Diversos articolos Articles divers Articoli diversi	PST 32	Asepsis Asepsis Asepsia Asepsie Asepsi
PAGE NO:	213 - 214	PAGE NO:	215 - 216

Skalpelle
Scalpels
Bisturies
Bistouris
Bisturi



01

01 - 05

Scheren
Scissors
Tijeras
Ciseaux
Forbic



02

06 - 25

Skalpelle
Scalpels
Bisturies
Bistouris
Bisturi

01



Quality Instruments

Anatomische Skalpelle

Dissecting Knives
Bisturías para disección
Bistouris à dissection
Bisturi per dissezione

Fig. 1 PST-01-101 15 cm / 5 7/8" 30mm	Fig. 2 PST-01-102 15 cm / 5 7/8" 35mm	Fig. 3 PST-01-103 15.5 cm / 6 1/8" 40mm	Fig. 4 PST-01-104 16 cm / 6 2/8" 45mm	Fig. 5 PST-01-105 16 cm / 6 2/8" 50mm	Fig. 6 PST-01-106 15 cm / 5 7/8" 27mm
PST-01-101 - 110 mit Metallheft with metal handle con mango metálico avec manche en métal con manico di metallo	Fig. 7 PST-01-107 15 cm / 5 7/8" 35mm	Fig. 8 PST-01-108 16 cm / 6 2/8" 40mm	Fig. 9 PST-01-109 16 cm / 6 2/8" 47mm	Fig. 10 PST-01-110 17 cm / 6 6/8" 50mm	

Seziermesser, Knorpelmesser

Autopsy Knives, Cartilage Knives
Cuchillos para autopsia, Cuchillos para cartilago
Couteaux à dissection, Couteaux à cartilage
Coltelli per autopsia, Coltelli per cartilagini

PST-01-111 25 cm / 9 7/8" mit Holzheft with wooden handle con mango de madera avec manche en bois con manico di legno	PST-01-112 21 cm / 8 2/8" mit Holzheft with wooden handle con mango de madera avec manche en bois con manico di legno
-----------------------------------------------------------------------------------------------------------------------------------------	-----------------------------------------------------------------------------------------------------------------------------------------

Hirnmesser

Brain Knives
Cuchillos para cerebro
Couteaux à cerveau
Coltelli per il cervello

PST-01-113 - PST-01-115 mit Hohlheft with hollow handle con mango hueco avec manche creux con manico vuoto	PST-01-113 26 cm / 10 1/4" 160mm	PST-01-114 33.5 cm / 13 1/4" 200mm	PST-01-115 38 cm / 15" 240mm
---------------------------------------------------------------------------------------------------------------------------	----------------------------------------	------------------------------------------	------------------------------------

Organmesser

Post Mortem Knives
Cuchillos para órganos
Couteaux à autopsie
Coltelli per autopsia

Walz PST-01-116 - PST-01-118 mit Holzheft with wooden handle con mango de madera avec manche en bois con manico di legno	PST-01-116 26 cm / 10 2/8" 110mm	PST-01-117 29 cm / 11 3/8" 140mm	PST-01-118 31 cm / 12 2/8" 170mm
--------------------------------------------------------------------------------------------------------------------------------------------	----------------------------------------	----------------------------------------	----------------------------------------

Skalpelle
Scalpels
Bisturios
Bistouri
Bisturi

01



Quality Instruments

Klingenhalter / Klingenbrecher

Blade Holders / Blade Breakers
Porta-hojas / Rompe-hojas de afeitador
Pincettes pour saisir et casser les lames de rasoir
Pinze per afferrare e rompere la lametta di rasoio



Griffdurchmesser
handle diameter
diámetro del mango
diamètre du manche
diametro di manico
5,5 mm



Griffdurchmesser
handle diameter
diámetro del mango
diamètre du manche
diametro di manico
5,5 mm

Troutman-Chris

PST-01-119
9cm / 3 4/8"

Troutman-Chris

PST-01-120
9cm / 3 4/8"



Griffdurchmesser
handle diameter
diámetro del mango
diamètre du manche
diametro di manico
8 mm

PST-01-123

Rasierklingen
brechbar
Packung mit 10 Stück
Razor Blades
breakable
package with 10 units
Lames de rasoir
cassable
boîte de 10 lames
Lametta da rasoio
rompibile
scatola di 10 lamette
Hojas de afeitador
rompeable
paquete con 10 unidades

Castroviejo

PST-01-121
11cm / 4 3/8"

PST-01-122
13cm / 5 1/8"

Skalpellgriffe

Scalpel Handles
Mangos de bisturí
Manches pour bistouris
Manici per bisturi



Collin

PST-01-124
13.5cm / 5 3/8"
mit Hohlheft
with hollow handle
con mango hueco
avec manche creux
con manico vuoto



Collin

PST-01-125
14.5cm / 5 6/8"



PST-01-126
13.5cm / 5 3/8"
mit Kunststoffheft
with plastic handle
con mango plástico
avec manche en matière p
con mango plástico



PST-01-127
16cm / 6 2/8"
1.0/1.5mm



PST-01-128
16cm / 6 2/8"
1.5/2.0mm



PST-01-129
15.5cm / 6 1/8"
Schwenkkopf
swivel head
con cabeza orientable
à tête pivotante
con testa inclinabile



PST-01-130
16.5cm / 6 2/8"



Skalpellgriffe

Scalpel Handles
Mangos de bisturí
Manches pour bistouris
Manici per bisturi



Fig. 18 - 36

Nr.4

PST-01-131
13.5cm / 5 3/8"
massiv
solid
macizo
solide
pieno



Fig. 10 - 36

Nr.38h4

PST-01-132
16cm / 6 2/8"



Fig. 18 - 36

Nr.4L

PST-01-133
21cm / 8 2/8"



Fig. 18 - 36

Nr.4L

PST-01-134
20.5cm / 8 1/8"



Skalpellgriffe

Scalpel Handles
Mangos de bisturí
Manches pour bistouris
Manici per bisturi



Fig. 10 - 17

Nr. 3

PST-01-135
12 cm / 4 6/8"
massiv
solid
macizo
solide
pieno



Fig. 10 - 17

Nr. 3

PST-01-136
12 cm / 4 6/8"



Fig. 10 - 17

Nr. 3L

PST-01-137
12 cm / 4 6/8"
massiv, mit Zentimeter-
Graduierung
solid,cm-graduation
macizo,graduadoen cm
solide,graduées cm
pieno,graduatoincm



Fig. 10 - 17

Nr. 3L

PST-01-138
21.5 cm / 8 4/8"
massiv, lang
solid, long
macizo, largo
solide, long
pieno, lungo



Fig. 10 - 17

Nr. 3L

PST-01-139
20.5 cm / 8 1/8"
massiv, abgewinkelt, lang
solid, angled, long
macizo, angulado, largo
solide, coudé, long
pieno, angolare, lungo



Skalpelle
Scalpels
Bisturies
Bistouris
Bisturi

01



Quality Instruments

Skalpellgriffe

Scalpel Handles
Mangos de bisturi
Manches pour bistouris
Manici per bisturi

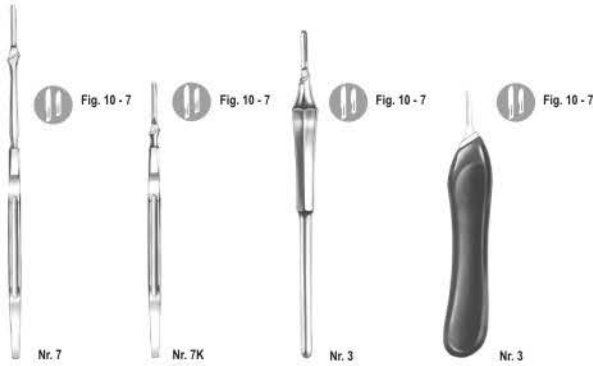

PST-01-140 16 cm / 6 2/8" massiv solid macizo solide pieno	PST-01-141 12.5 cm / 4 7/8" massiv solid macizo solide pieno	PST-01-142 12.5 cm / 6 1/8" mit rundem Hohlheft with round hollow handle con mango hueco redondo avec manche creux rond con manico vuoto rotondo	PST-01-143 12.5 cm / 4 7/8" mit Kunststoffheft with plastic handle con mango plástico avec manche en matière plastique con manico di materia plastica
------------------------------------------------------------------------------	--------------------------------------------------------------------------------	--------------------------------------------------------------------------------------------------------------------------------------------------------------------	-------------------------------------------------------------------------------------------------------------------------------------------------------------------------



Skalpellgriffe

Scalpel Handles
Mangos de bisturi
Manches pour bistouris
Manici per bisturi

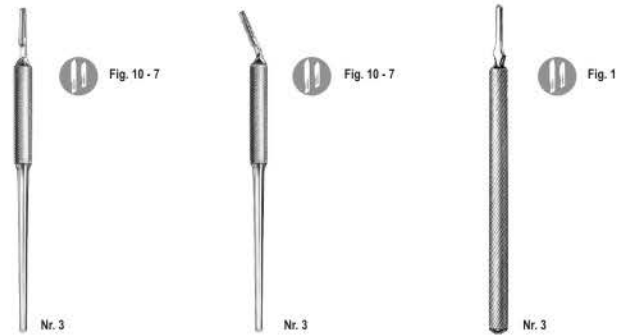

PST-01-144 14 cm / 5 4/8" massiv solid macizo solide pieno	PST-01-145 14 cm / 5 4/8" massiv solid macizo solide pieno	Kaye PST-01-146 15 cm / 5 7/8" massiv solid macizo solide pieno
------------------------------------------------------------------------------	------------------------------------------------------------------------------	--------------------------------------------------------------------------------------



Skalpellschlingen

Scalpel Blades
Hojas de bisturi
Lames de bistouris
Lame per bisturi



PST-01-147
Skalpellschlingen-Entferner
Scalpel Blade Remover
Quita-hojas
Enlève-lame
Distributore lame



steril • sterile • estéril
PST-01-148

Sägeblatt
für Griffe No. 3
Packung mit 1 Stück

Saw Blade
for handles no. 3
package with 1 unit



unsteril • non-sterile • no estéril • non-stérile • non sterile
PST-01-149 PST-01-150 PST-01-151 PST-01-152 PST-01-153
Fig. 10 Fig. 11 Fig. 12 Fig. 13 Fig. 15

Hoja de sierra
para mangos no. 3
paquete con 1 unidad

steril • sterile • estéril • stérile • sterile
PST-01-149 PST-01-150 PST-01-151 PST-01-152 PST-01-153
Fig. 10 Fig. 11 Fig. 12 Fig. 13 Fig. 15

Lames de scies
pour manche no. 3
boite de 1 lame



unsteril • non-sterile • no estéril • non-stérile • non sterile
PST-01-154 PST-01-155 PST-01-156 PST-01-157
Fig. 16 Fig. 17 Fig. 12 D Fig. 15 C

einzel verpackt, VE = 100 Stück
single packed, SU = 100/pack
envase individual, UV = 100 piezas
enveloppe individuelle,
UC = 100 unties
bustina individuale, UV = 100 pezzi

steril • sterile • estéril • stérile • sterile
PST-01-154 PST-01-155 PST-01-156 PST-01-157
Fig. 16 Fig. 17 Fig. 12 D Fig. 15 C



Skalpellschlingen

Scalpel Blades
Hojas de bisturi
Lames de bistouris
Lame per bisturi



unsteril • non-sterile • no estéril • non-stérile • non sterile
PST-01-158 PST-01-159 PST-01-160 PST-01-161 PST-01-162 PST-01-163
Fig. 18 Fig. 19 Fig. 20 Fig. 21 Fig. 22 Fig. 23

steril • sterile • estéril • stérile • sterile
PST-01-158 PST-01-159 PST-01-160 PST-01-161 PST-01-162 PST-01-163
Fig. 18 Fig. 19 Fig. 20 Fig. 21 Fig. 22 Fig. 23



einzel verpackt, VE = 100 Stück
single packed, SU = 100/pack
envase individual, UV = 100 piezas
enveloppe individuelle,
UC = 100 unties
bustina individuale, UV = 100 pezzi

unsteril • non-sterile • no estéril • non-stérile • non sterile
PST-01-164 PST-01-165 PST-01-166
Fig. 24 Fig. 34 Fig. 36

steril • sterile • estéril • stérile • sterile
PST-01-164 PST-01-165 PST-01-166
Fig. 24 Fig. 34 Fig. 36



Skalpelle

Scalpels
Bisturies
Bistouris
Bisturi

01



Quality Instruments

Skalpellgriffe, Mikro-Skalpellklingen

Scalpel Handles, Micro Scalpel Blades
Mangos de bisturí, Micro hojas de bisturí
Manches pour bistouris, Micro lames de bistouris
Manici per bisturí, Micro lame per bisturí

PST-01-167
13.5 cm / 5 3/8"

für Mikro-Skalpellklingen
for micro scalpel blades
para micro hojas
pour micro-lames de bisturis
per micro lame

einzel verpackt
Packung mit 25 Stück
single packed
package with 25 units
envase individual

paquete con 25 unidades
enveloppe individuelle
boîte de 25 lames
bustina individuale
scatola di 25 lame



steril • sterile • estéril • stérile • sterile
PST-01-168 Fig. 61 PST-01-169 Fig. 62 PST-01-170 Fig. 63 PST-01-171 Fig. 64 PST-01-172 Fig. 65

PST-01-173
13.5 cm / 5 3/8"

für Mikro-Skalpellklingen
for micro scalpel blades
para micro hojas
pour micro-lames de bisturis
per micro lame



steril • sterile • estéril • stérile • sterile
PST-01-174 Fig. 66 PST-01-175 Fig. 67 PST-01-176 Fig. 68 PST-01-177 Fig. 69

Einmalskalpelle

Disposable Scalpels
Bisturies desechables
Bistouris à usage unique
Bisturi per uso unico

steril
einzel verpackt
sterile
single packed
package with 10 units
estéril
envase individual
paquete con 10 unidades

stérile
enveloppe individuelle
boîte de 10 bisturis
sterile
bustina individuale
scatola di 10 bisturi



steril • sterile • estéril • stérile • sterile
PST-01-178 Fig. 18 PST-01-179 Fig. 19 PST-01-180 Fig. 20 PST-01-181 Fig. 21 PST-01-182 Fig. 22 PST-01-183 Fig. 23 PST-01-184 Fig. 24

Einmalskalpelle

Disposable Scalpels
Bisturies desechables
Bistouris à usage unique
Bisturi per uso unico

steril
einzel verpackt
sterile
single packed
package with 10 units
estéril
envase individual
paquete con 10 unidades

stérile
enveloppe individuelle
boîte de 10 bisturis
sterile
bustina individuale
scatola di 10 bisturi



steril • sterile • estéril • stérile • sterile
PST-01-185 Fig. 10 PST-01-186 Fig. 11 PST-01-187 Fig. 12 PST-01-188 Fig. 13 PST-01-189 Fig. 15 PST-01-190 Fig. 12 D PST-01-191 Fig. 15 C

Amputationsmesser

Amputation Knives
Cuchillos para amputación
Couteaux à amputation
Coltelli per amputazione



160 mm

PST-01-192
29 cm / 11 3/8"
mit Hohlheft
with hollow handle
con mango hueco
avec manche creux
con manico vuoto



190 mm

PST-01-193
32 cm / 12 5/8"
mit Hohlheft
with hollow handle
con mango hueco
avec manche creux
con manico vuoto

Skalpelle
Scalpels
Bisturios
Bistouri
Bisturi

01



Quality Instruments

Resektionsmesser

Resection Knives
Cuchillos para resección
Couteaux à résection
Coltelli per resezione



PST-01-194
19 cm / 7 4/8"
massives Heft mit Schaber-Ende
solid handle, with dissecting end
mango macizo, con periostótomo
manche solide à rugine
con manico pieno con raschino

Langenbeck
PST-01-195
18 cm / 7 1/8"
mit Hohlheft
with hollow handle
con mango hueco
avec manche creux
con manico vuoto

Langenbeck
PST-01-196
18 cm / 7 1/8"
mit Hohlheft
with hollow handle
con mango hueco
avec manche creux
con manico vuoto

Rasiermesser

Razor Knives
Navajas
Rasoirs
Rasoii



PST-01-197
Klinge beidseitig hohl
hollow blade on both sides
ambos lados cóncavos
lame deux faces concaves
lama concava/concava

PST-01-198
Klinge flach/hohl
blade flat/hollow
hoja cóncava/convexa
lame à faces plane/concave
lama piana/concava



Record-Arkansas
PST-01-199
Abziehstein, im Holzkasten
Sharpening Stone, in wooden case
Piedra afiladora, en caja madera
Pierre à repasser, en boîte bois
Pietra per affilare, in astuccio di legno



Record-Arkansas
PST-01-200
Abziehstein
Sharpening Stone
Piedra afiladora
Pierre à repasser
Pietra per affilare



Dermatome

Dermatomes
Dermátomos
Dermatomes
Dermatomi



Humby
PST-01-202
Ersatzklinge
Spare Blade
Hoja de repuesto
Lame de rechange, seule
Lama di ricambio sola

Schink
PST-01-204
Ersatzklinge
Spare Blade
Hoja de repuesto
Lame de rechange, seule
Lama di ricambio sola

Humby
PST-01-201
32 cm / 12 5/8"
komplett mit Klinge
complete with blade
completo con hoja
complet avec lame
completo con lama

Schink
PST-01-203
30 cm / 11 6/8"
einstellbar von 0,1 bis 2,0 mm
adjustable from 0.1 to 2.0 mm
ajustable de 0,1 hasta 2,0 mm
réglable en épaisseur de 0,1 à 2,0 mm
regolabile da 1,0 a 2,0 mm
komplett mit 2 Spannplatten und einer Klinge
complete with 2 skin fixing plates and one blade
completo con 2 placas para extender la piel y una hoja

Schink
PST-01-205
Spannplatte
Skin Fixing Plate
Placa para extender la piel
Plaque pour tendre la peau
Placca per stendere la pelle



Dermatome

Dermatomes
Dermátomos
Dermatomes
Dermatomi



Silver
PST-01-206
19,5 cm / 7 5/8"
für handelsübliche Rasierklingen
for usual razor blades
para hojas de afeitar usuales
pour lames de rasoir modèle standard
per lamette da barba normali

Aortastanzen
Aorta Punches
Perforadores aórticos
Rongeurs pour aorte
Pinze taglianti per aorta



PST-01-207 - PST-01-208
16 cm / 6 1/8"



PST-01-207
Ø 4,0 mm



PST-01-208
Ø 5,0 mm



Scheren
Scissors
Tijeras
Ciseaux
Forbic

02



Quality Instruments

Chirurgische Scheren

Operating Scissors
Tijeras quirúrgicas
Ciseaux chirurgicaux
Forbici per chirurgia

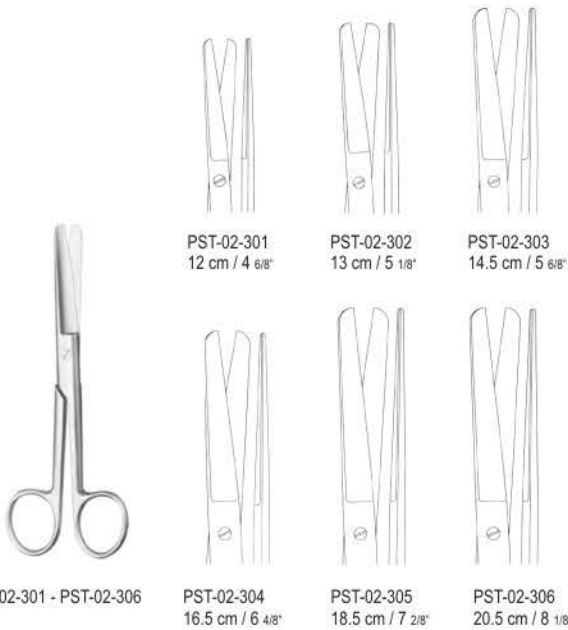

PST-02-301 - PST-02-306



Chirurgische Scheren

Operating Scissors
Tijeras quirúrgicas
Ciseaux chirurgicaux
Forbici per chirurgia



PST-02-307 - PST-02-312



Chirurgische Scheren

Operating Scissors
Tijeras quirúrgicas
Ciseaux chirurgicaux
Forbici per chirurgia

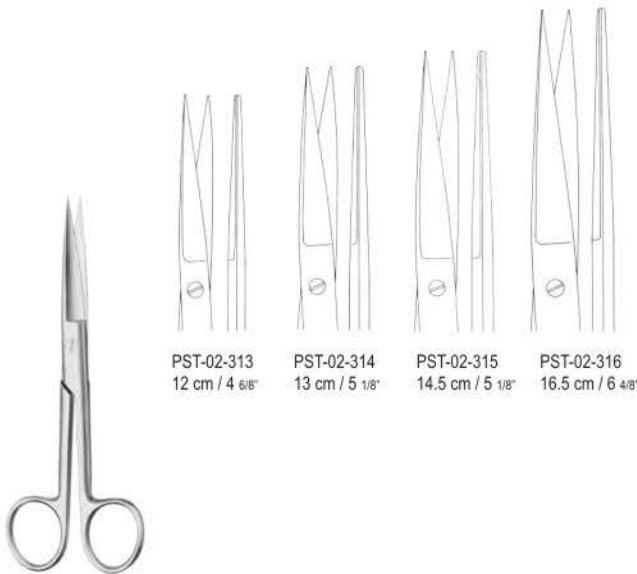

PST-02-313 - PST-02-316



Chirurgische Scheren

Operating Scissors
Tijeras quirúrgicas
Ciseaux chirurgicaux
Forbici per chirurgia

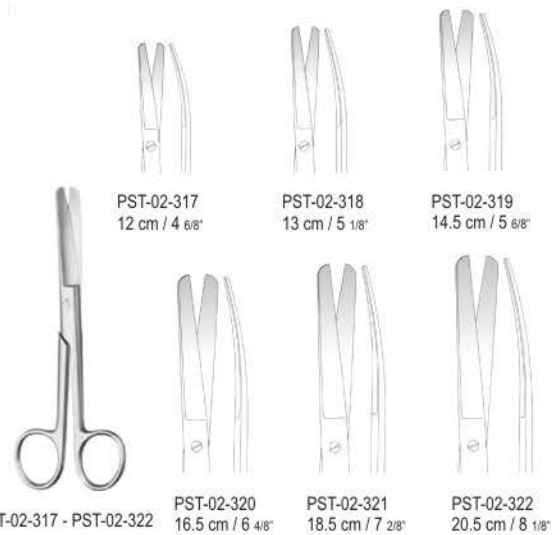

PST-02-317 - PST-02-322



Scheren Scissors
Tijeras Tijeras
Ciseaux Ciseaux
Forbic Forbic 02



Quality Instruments

Chirurgische Scheren
Operating Scissors
Tijeras quirúrgicas
Ciseaux chirurgicaux
Forbici per chirurgia

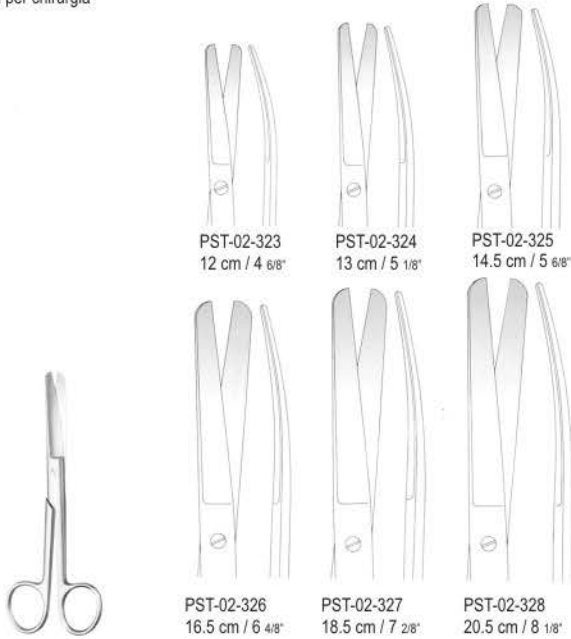

PST-02-323 - PST-02-328

Chirurgische Scheren
Operating Scissors
Tijeras quirúrgicas
Ciseaux chirurgicaux
Forbici per chirurgia

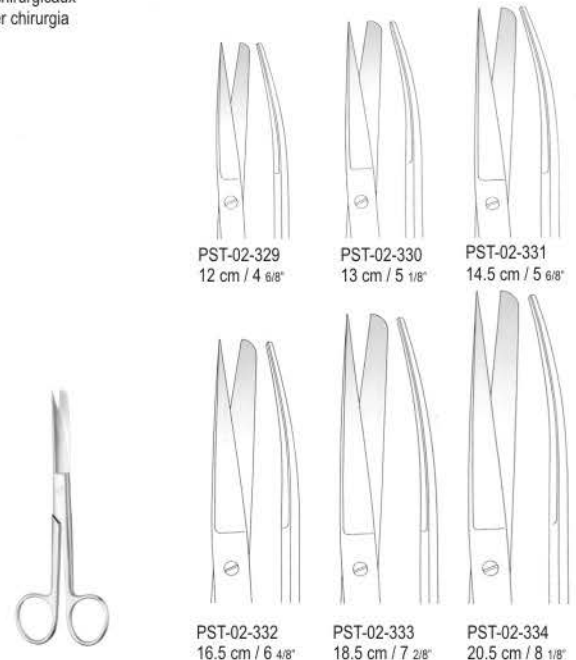

PST-02-329 - PST-02-334

Chirurgische Scheren
Operating Scissors
Tijeras quirúrgicas
Ciseaux chirurgicaux
Forbici per chirurgia

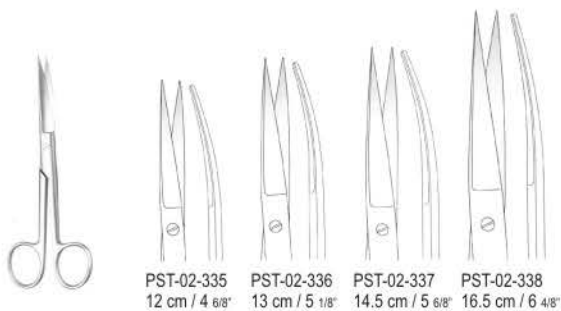

PST-02-335 - PST-02-338

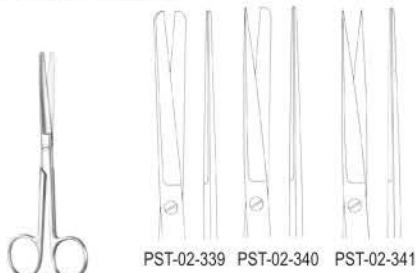

PST-02-339 - PST-02-341
14.5 cm / 5 6/8"

Chirurgische Scheren
Operating Scissors
Tijeras quirúrgicas
Ciseaux chirurgicaux
Forbici per chirurgia

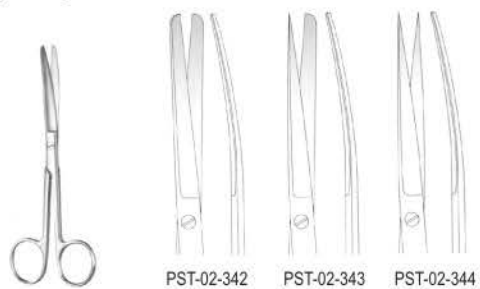

PST-02-342 - PST-02-344
14.5 cm / 5 6/8"

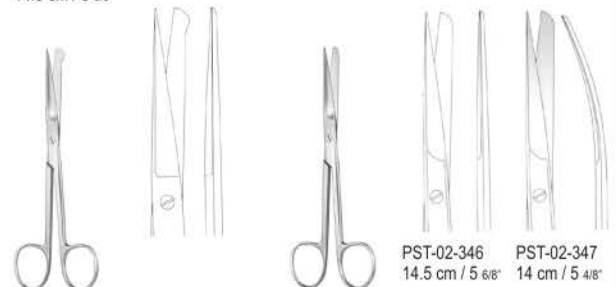

PST-02-345
14.5 cm / 5 6/8"

Deaver
PST-02-346 - PST-02-347

Scheren
 Scissors
 Tijeras
 Ciseaux
 Forbic

02



Quality Instruments

Präparierscheren

Dissecting Scissors
 Tijeras de disección
 Ciseaux à dissection
 Forbici per dissezione

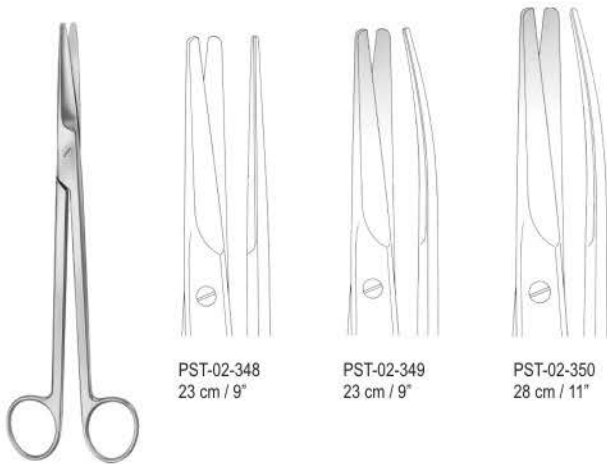

PST-02-348
23 cm / 9"

PST-02-349
23 cm / 9"

PST-02-350
28 cm / 11"

Mayo-Harrington
 PST-02-348 - PST-02-350



Präparierscheren

Dissecting Scissors
 Tijeras de disección
 Ciseaux à dissection
 Forbici per dissezione

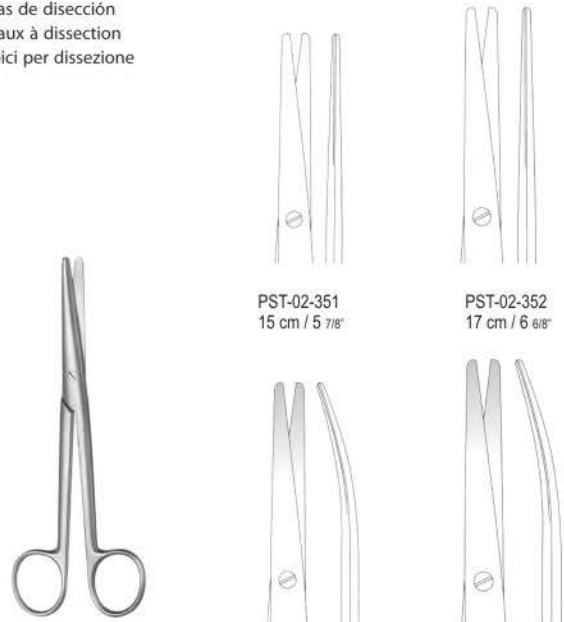

PST-02-351
15 cm / 5 7/8"

PST-02-352
17 cm / 6 6/8"

PST-02-353
15 cm / 5 7/8"

PST-02-354
17 cm / 6 6/8"

Mayo-Stille
 PST-02-351 - PST-02-354



Präparierscheren

Dissecting Scissors
 Tijeras de disección
 Ciseaux à dissection
 Forbici per dissezione

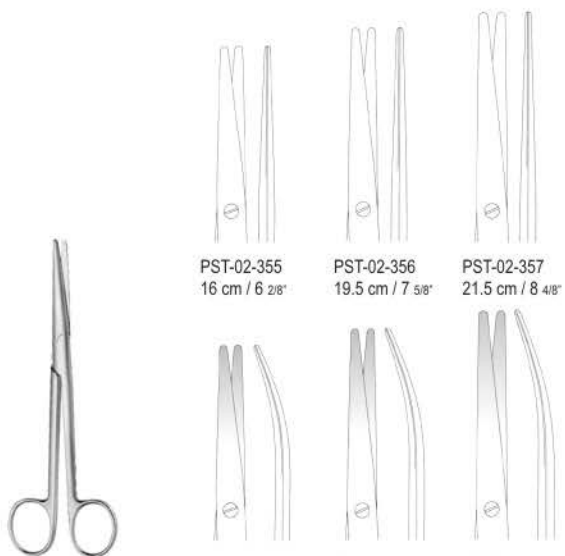

PST-02-355
16 cm / 6 2/8"

PST-02-356
19.5 cm / 7 5/8"

PST-02-357
21.5 cm / 8 4/8"

PST-02-358
16 cm / 6 2/8"

PST-02-359
19.5 cm / 7 5/8"

PST-02-360
21.5 cm / 8 4/8"

Mayo-Stille
 PST-02-355 - PST-02-360



Präparierscheren

Dissecting Scissors
 Tijeras de disección
 Ciseaux à dissection
 Forbici per dissezione

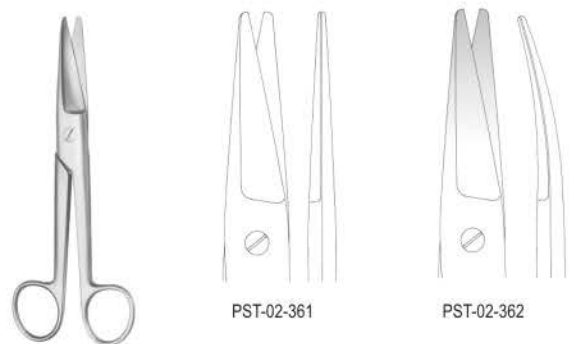

PST-02-361

PST-02-362

Mayo-Noble
 PST-02-361 - PST-02-362
 16.5 cm / 6 4/8"



Scheren
 Scissors
 Tijeras
 Ciseaux
 Forbic
 02



Quality Instruments

Gynäkologische Scheren

Gynecological Scissors
 Tijeras para ginecología
 Ciseaux à gynécologie
 Forbici per ginecologia



Sims
 PST-02-363 - PST-02-366



PST-02-363
 20 cm / 7 7/8"



PST-02-364
 23 cm / 9"



PST-02-365
 20 cm / 7 7/8"



PST-02-366
 23 cm / 9"

Chirurgische Scheren, Gynäkologische Scheren

Operating Scissors, Gynecological Scissors
 Tijeras quirúrgicas, Tijeras para ginecología
 Ciseaux chirurgicaux, Ciseaux à gynécologie
 Forbici per chirurgia, Forbici per ginecologia



Kelly
 PST-02-367 - PST-02-368
 16 cm / 6 2/8"



PST-02-367



PST-02-368



Doyen
 PST-02-369 - PST-02-370
 18.5 cm / 7 2/8"



PST-02-369



PST-02-370

Gynäkologische Scheren

Gynecological Scissors
 Tijeras para ginecología
 Ciseaux à gynécologie
 Forbici per ginecologia



Sims-Siebold
 PST-02-371
 24.5 cm / 9 5/8"

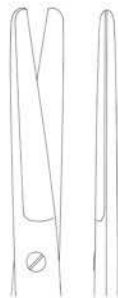

Sims-Siebold
 PST-02-372
 24.5 cm / 9 5/8"



Gynäkologische Scheren

Gynecological Scissors
 Tijeras para ginecología
 Ciseaux à gynécologie
 Forbici per ginecologia



Wertheim
 PST-02-373 - PST-02-374



PST-02-373
 20 cm / 7 7/8"



PST-02-374
 23 cm / 9"

Scheren
Scissors
Tijeras
Ciseaux
Forbic



Quality Instruments

Präparierscheren

Dissecting Scissors
Tijeras de disección
Ciseaux à dissection
Forbici per dissezione



Metzenbaum
PST-02-375 - 376
11.5 cm / 4 4/8"



PST-02-375



PST-02-376



PST-02-377



PST-02-378



PST-02-379



PST-02-380



PST-02-381

Metzenbaum

PST-02-377 - PST-02-382
14.5 cm / 5 4/8"

Präparierscheren

Dissecting Scissors
Tijeras de disección
Ciseaux à dissection
Forbici per dissezione



Metzenbaum
PST-02-383 - PST-02-384
15.5 cm / 6 1/8"



PST-02-383



PST-02-384



Metzenbaum-Nelson
PST-02-385 - PST-02-389



PST-02-385
18 cm / 7 1/8"



PST-02-386
20.5 cm / 8 1/8"



PST-02-387
23 cm / 9"



PST-02-388
26 cm / 10 2/8"



PST-02-389
28.5 cm / 11 2/8"



Präparierscheren

Dissecting Scissors
Tijeras de disección
Ciseaux à dissection
Forbici per dissezione



PST-02-390
18 cm / 7 1/8"



PST-02-391
20.5 cm / 8 1/8"

Metzenbaum-Nelson

PST-02-390 - PST-02-391
15.5 cm / 6 1/8"



PST-02-392
18 cm / 7 1/8"



PST-02-393
20.5 cm / 8 1/8"



PST-02-394
23 cm / 9"



PST-02-395
26 cm / 10 2/8"



PST-02-396
28.5 cm / 11 2/8"



PST-02-397
31 cm / 12 2/8"

Metzenbaum-Nelson

PST-02-392 - PST-02-397

Präparierscheren

Dissecting Scissors
Tijeras de disección
Ciseaux à dissection
Forbici per dissezione



Metzenbaum
PST-02-398 - PST-02-399
14.5 cm / 5 6/8"

eine Schneide gezahnt
one toothed cutting edge
una hoja dentada
une lame dentelée
una lama dentata



PST-02-398



PST-02-399



PST-02-400 - 401
15.5 cm / 6 1/8"
Nerv-Präparierschere
Nerve Dissecting Scissors
Tijeras para disección de nervios
Ciseaux pour nerfs
Forbici per nervi



PST-02-400



PST-02-401



Scheren Scissors
Tijeras Tijeras
Ciseaux Forbic
02



Quality Instruments

Face-lift-Scheren

Face-lift Scissors
Tijeras para Face-Lift
Ciseaux pour Face-lift
Forbici per Face-lift



Kaye

PST-02-402
18,5 cm / 7 2/8"
eine Schneide gezahnt
one toothed cutting edge
una hoja dentada
une lame dentelée
una lama dentata



Aston

PST-02-403
17 cm / 6 6/8"
eine Schneide gezahnt
one toothed cutting edge
una hoja dentada
une lame dentelée
una lama dentata



Gorney

PST-02-404 - PST-02-406
eine Schneide gezahnt
one toothed cutting edge
una hoja dentada
une lame dentelée
una lama dentata



PST-02-404
12,5 cm / 4 7/8"

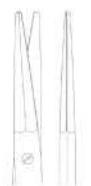

PST-02-405
19,5 cm / 7 5/8"



PST-02-406
19,5 cm / 7 5/8"

Präparierscheren, Nasenscheren

Dissecting Scissors, Nasal Scissors
Tijeras de disección, Tijeras nasales
Ciseaux à dissection, Ciseaux nasaux
Forbici per dissezione, Forbici nasali



Lexer

PST-02-407 - PST-02-408
16 cm / 6 2/8"



PST-02-407



PST-02-408



Cinelli

PST-02-409
11,5 cm / 4 4/8"



PST-02-409



Fomon

PST-02-410
14 cm / 5 4/8"

PST-02-410



Thorek

PST-02-411
18,5 cm / 7 2/8"



Lexer-Baby

PST-02-412 - PST-02-413
10 cm / 3 7/8"

PST-02-412

PST-02-413

Feine Präparierscheren

Delicate Dissecting Scissors
Tijeras finas de disección
Ciseaux fins à dissection
Forbici fini per dissezione



Lexer-Fino

PST-02-414
16,5 cm / 6 4/8"



schlankes Modell
slender pattern
modelo delgado
modèle gracile
modello delicato



Lexer-Fino

PST-02-415
16,5 cm / 6 4/8"



Metzenbaum-Fino

PST-02-416
14,5 cm / 5 6/8"



Metzenbaum-Fino

PST-02-417
14,5 cm / 5 6/8"



schlankes Modell
slender pattern
modelo delgado
modèle gracile
modello delicato



Metzenbaum-Fino

PST-02-418
14,5 cm / 5 6/8"



Metzenbaum-Fino

PST-02-419
14,5 cm / 5 6/8"



Feine Präparierscheren

Delicate Dissecting Scissors
Tijeras finas de disección
Ciseaux fins à dissection
Forbici fini per dissezione



Metzenbaum-Fino

PST-02-420 - PST-02-422

schlankes Modell
slender pattern
modelo delgado
modèle gracile
modello delicato



PST-02-420
18 cm / 7 1/8"



PST-02-421
20,5 cm / 8 1/8"



PST-02-422
23 cm / 9"



Metzenbaum-Fino

PST-02-423 - PST-02-425

schlankes Modell
slender pattern
modelo delgado
modèle gracile
modello delicato



PST-02-423
18 cm / 7 1/8"



PST-02-424
20,5 cm / 8 1/8"



PST-02-425
23 cm / 9"

Scheren
Scissors
Tijeras
Ciseaux
Forbic



Quality Instruments

Feine Präparierscheren

Delicate Dissecting Scissors
Tijeras finas de disección
Ciseaux fins à dissection
Forbici fini per dissezione

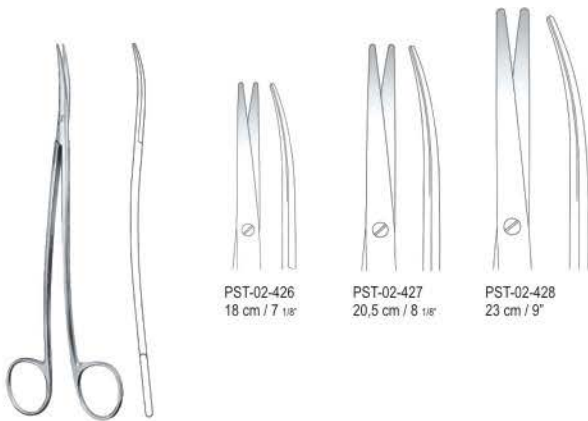

PST-02-426
18 cm / 7 1/8"

PST-02-427
20,5 cm / 8 1/8"

PST-02-428
23 cm / 9"

Metzenbaum-Fino

PST-02-426 - PST-02-428

schlankes Modell, S-Form
slender pattern, S-shaped
modelo delgado, forma S
modèle gracile, courbé en S
modello delicato, curvo in forma S

Präparierscheren, Chirurgische Scheren

Dissecting Scissors, Operating Scissors
Tijeras de disección, Tijeras quirúrgicas
Ciseaux à dissection, Ciseaux chirurgicaux
Forbici per dissezione, Forbici per chirurgia

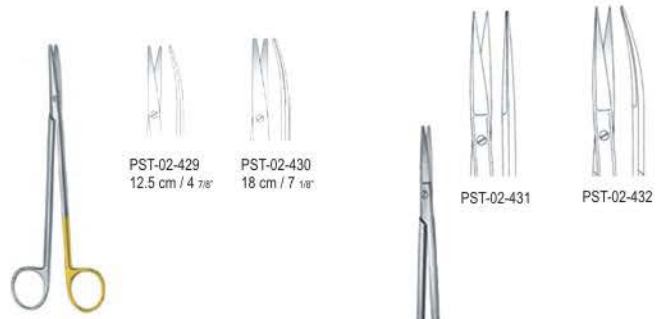

PST-02-429
12,5 cm / 4 7/8"

PST-02-430
18 cm / 7 1/8"

PST-02-431

PST-02-432

Salyer

PST-02-429 - PST-02-430

feines Modell, eine Schneide mit Messerschiff
delicate pattern, one cutting edge with knife cut
modelo delicado, una hoja con afilado de cuchillo
modèle fin, une lame avec taille de couteau
modello fino, una lama con affilatura di coltello

Sanvenero

PST-02-431 - PST-02-432

14 cm / 5 4/8"

Präparierscheren, Chirurgische Scheren

Dissecting Scissors, Operating Scissors
Tijeras de disección, Tijeras quirúrgicas
Ciseaux à dissection, Ciseaux chirurgicaux
Forbici per dissezione, Forbici per chirurgia

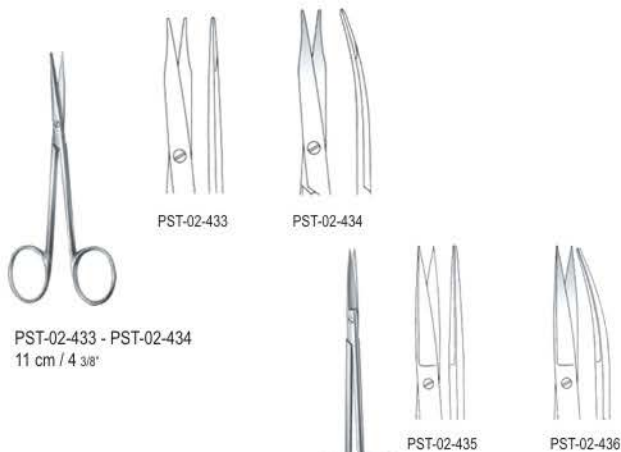

PST-02-433

PST-02-434

PST-02-435

PST-02-436

PST-02-433 - PST-02-434
11 cm / 4 3/8"

Joseph

PST-02-435 - PST-02-436

14,5 cm / 5 6/8"

für Lippen-, Kiefer-, Gaumenspalte
for Cleft Palate
para fisura paladar
pour fente du palais
per chello-labbro-palato schisi

Face-lift-Scheren, Präparierscheren

Face-lift Scissors, Dissecting Scissors
Tijeras para Face-lift, Tijeras de disección
Ciseaux pour Face-lift, Ciseaux à dissection
Forbici per Face-lift, Forbici per dissezione

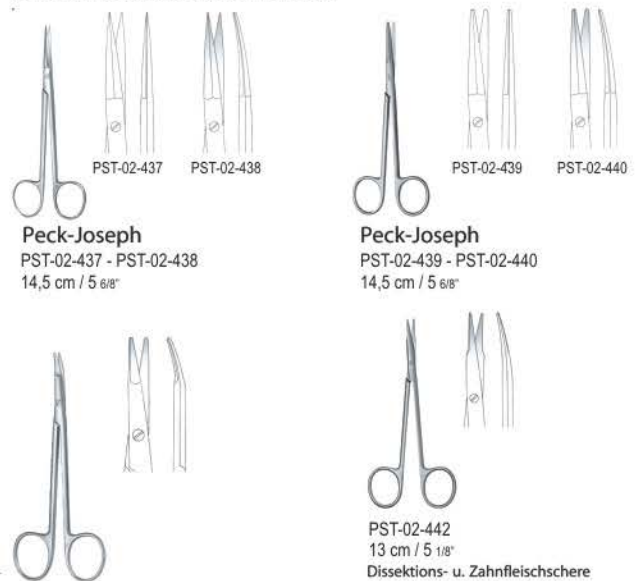

PST-02-437

PST-02-438

PST-02-439

PST-02-440

Peck-Joseph

PST-02-437 - PST-02-438

14,5 cm / 5 6/8"

Peck-Joseph

PST-02-439 - PST-02-440

14,5 cm / 5 6/8"

Shea Vein Graft

PST-02-441

12 cm / 4 6/8"

PST-02-442

13 cm / 5 1/8"

Dissektions- u. Zahnfleischschere
Dissecting Scissors
Tijera de disección
Ciseaux à dissection
Forbici per dissezione



Scheren
Scissors
Tijeras
Ciseaux
Forbic

02



Quality Instruments

Face-lift-Scheren, Präparierscheren

Face-lift Scissors, Dissecting Scissors
Tijeras para Face-lift, Tijeras de disección
Ciseaux pour Face-lift, Ciseaux à dissection
Forbici per Face-lift, Forbici per dissezione



Kilner

PST-02-443 - PST-02-444



PST-02-443
12 cm / 4 6/8"



PST-02-444
15 cm / 5 7/8"



PST-02-445 - PST-02-446
14,5 cm / 5 6/8"



PST-02-445



PST-02-446

Präparierscheren, Gefäßscheren

Dissecting Scissors, Vascular Scissors
Tijeras de disección, Tijeras vasculares
Ciseaux à dissection, Ciseaux vasculaires
Forbici per dissezione, Forbici vascolari



PST-02-447
15,5 cm / 6 1/8"



PST-02-448
15,5 cm / 6 1/8"



PST-02-449
18 cm / 7 1/8"



Jameson

PST-02-450
15,5 cm / 6 1/8"

Reynolds

PST-02-447 - PST-02-449



Jameson

PST-02-451
15,5 cm / 6 1/8"
eine Schneide gezahnt
one toothed cutting edge
una hoja dentada
une lame dentelée
una lama dentata



PST-02-452 - PST-02-453
20 cm / 7 7/8"



PST-02-452



PST-02-453

Gefäßscheren, Präparierscheren

Vascular Scissors, Dissecting Scissors
Tijeras vasculares, Tijeras de disección
Ciseaux vasculaires, Ciseaux à dissection
Forbici vascolari, Forbici per dissezione



Satinsky

PST-02-454
25,5 cm / 10"



Diethrich-Salyer

PST-02-455
12 cm / 4 6/8"
ein Blatt mit Messerschiff
one cutting edge with knife cut
una hoja con afilado de cuchillo
une lame avec taille de couteau
una lama con affilatura di coltello
für Lippen-, Kiefer-, Gaumenspalte
for Cleft Palate
para fisura paladar
pour fente du palais
per chello-labbro-palato schisi

Gefäßscheren, Koronarscheren

Vascular Scissors, Coronary Scissors
Tijeras vasculares, Tijeras coronarias
Ciseaux vasculaires, Ciseaux coronaires
Forbici vascolari, Forbici per arteria coronaria



PST-02-456
19 cm / 7 4/8"



7 mm
25°



PST-02-457
18,5 cm / 7 2/8"



7 mm
45°



PST-02-458
17,5 cm / 6 7/8"



7 mm
60°



PST-02-459
17,5 cm / 6 7/8"



7 mm
90°

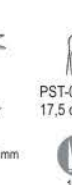

PST-02-460
17,5 cm / 6 7/8"



7 mm
125°

Diethrich

PST-02-456 - PST-02-460



PST-02-461
7 mm
25°



PST-02-462
7 mm
45°



PST-02-463
7 mm
60°



PST-02-464
7 mm
90°



PST-02-465
7 mm
125°

Mikro-Hegemann

PST-02-461 - PST-02-465
18,5 cm / 7 2/8"

Scheren Scissors
Tijeras Tijeras
Ciseaux Ciseaux
Forbic Forbic 02



Quality Instruments

Gefäßscheren

Vascular Scissors
Tijeras vasculares
Ciseaux vasculaires
Forbici vascolari



De Bakey
PST-02-466 - PST-02-467
16 cm / 6 2/8"

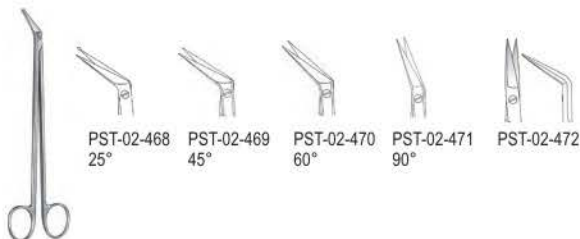

Potts-Smith
PST-02-468 - PST-02-472
19 cm / 7 4/8"

Koronarscheren

Coronary Scissors
Tijeras coronarias
Ciseaux coronaires
Forbici per arteria coronaria

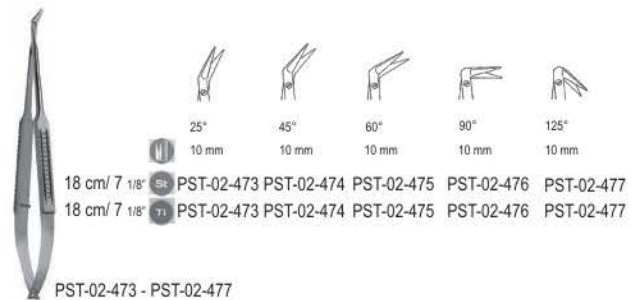

18 cm / 7 1/8" PST-02-473 PST-02-474 PST-02-475 PST-02-476 PST-02-477
18 cm / 7 1/8" PST-02-473 PST-02-474 PST-02-475 PST-02-476 PST-02-477

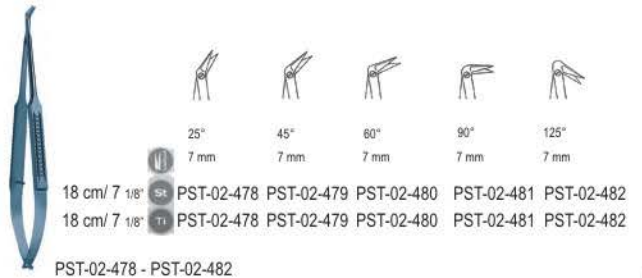

18 cm / 7 1/8" PST-02-478 PST-02-479 PST-02-480 PST-02-481 PST-02-482
18 cm / 7 1/8" PST-02-478 PST-02-479 PST-02-480 PST-02-481 PST-02-482

Gefäßscheren

Vascular Scissors
Tijeras vasculares
Ciseaux vasculaires
Forbici vascolari

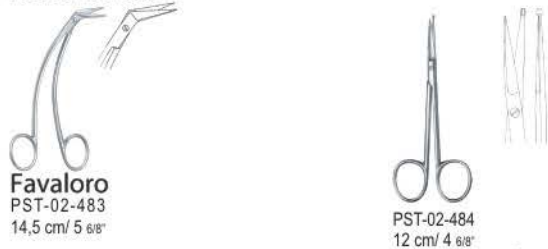

Favaloro
PST-02-483
14,5 cm / 5 6/8"

PST-02-484
12 cm / 4 6/8"



Strully
PST-02-485
22 cm / 8 5/8"
Neurochirurgische Schere
Neurosurgical Scissors
Tijera para neurocirugía
Ciseaux pour neurochirurgie
Forbici per neurochirurgia



Schmieden-Taylor
PST-02-486
16,5 cm / 6 4/8"
Duraschere
Dura Scissors
Tijera para duramadre
Ciseaux pour la dure-mère
Forbici per dura madre

Präparierscheren

Dissecting Scissors
Tijeras de disección
Ciseaux à dissection
Forbici per dissezione



Toennis-Adson
PST-02-487
17,5 cm / 6 7/8"

Olivecrona
PST-02-488

Trigeminusschere
Trigeminal Scissors
Tijera para nervio trigémino
Ciseaux pour le nerf trigéminale
Forbici per il nervo trigemino



Scheren
Scissors
Tijeras
Ciseaux
Forbic 02



Quality Instruments

Tonsillenscheren

Tonsil Scissors
Tijeras para amígdalas
Ciseaux pour les amygdales
Forbici per tonsille

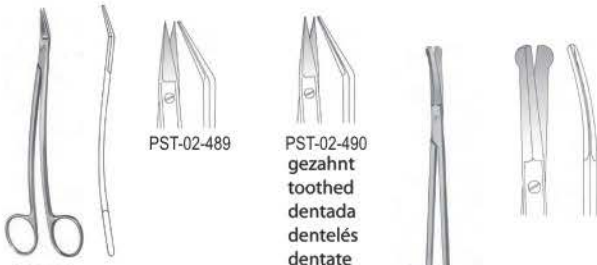

Dean
PST-02-489 - PST-02-490
17,5 cm / 6 7/8"

PST-02-490
gezahnt
toothed
dentada
dentelés
dentate

Good
PST-02-491
19,5 cm / 7 5/8"

Nasenscheren

Nasal Scissors
Tijeras nasales
Ciseaux nasaux
Forbici nasali

TC-GOLD



Fomon
PST-02-492
14,5 cm / 5 6/8"

Cottle
PST-02-494
16 cm / 6 2/8"



Fomon
PST-02-493
14 cm / 5 4/8"

Nasenscheren

Nasal Scissors
Tijeras nasales
Ciseaux nasaux
Forbici nasali



Cottle
PST-02-495
15,5 cm / 6 1/8"

Heymann
PST-02-496

Arbeitslänge
working length
largo útil
longueur utile
lunghezza utile
85 mm

PST-02-498
stumpf
blunt
romo
mousse
smusso

PST-02-499
spitz
sharp
agudo
pointu
appuntato

Converse

PST-02-498 - PST-02-499
10,5 cm / 4 1/8"



Heymann
PST-02-497
eine Schneide gezahnt
one toothed cutting edge
una hoja dentada
une lame dentelée
una lama dentata

Arbeitslänge
working length
largo útil
longueur utile
lunghezza utile
85 mm

Episiotomiescheren

Episiotomy Scissors
Tijeras para episiotomía
Ciseaux à épisiotomie
Forbici per episiotomia



Waldmann
PST-02-500
18 cm / 7 1/8"

Braun-Stadler
PST-02-501
14,5 cm / 5 6/8"

eine Schneide gezahnt
one toothed cutting edge
una hoja dentada
une lame dentelée
una lama dentata



Braun-Stadler
PST-02-502
22 cm / 8 5/8"

Scheren
Scissors
Tijeras
Ciseaux
Forbic

02



Quality Instruments

Nabelschnurscheren

Umbilical Scissors
Tijeras umbilicales
Ciseaux pour le cordon ombilical
Forbici ombelicali



Mod. USA
PST-02-503
10,5 cm / 4 1/8"



Busch
PST-02-505
16 cm / 6 2/8"



Schuhmacher
PST-02-504
15,5 cm / 6 1/8"



Busch
PST-02-506
16 cm / 6 2/8"
eine Schneide gezahnt
one toothed cutting edge
una hoja dentada
une lame dentelée
una lama dentata

Chirurgische Scheren, Zahnfleischscheren

Operating Scissors, Gum Scissors
Tijeras quirúrgicas, Tijeras para encías
Ciseaux chirurgicaux, Ciseaux à gencives
Forbici per chirurgia, Forbici per gengiva



Goldman-Fox
PST-02-507 - PST-02-508
13 cm / 5 1/8"
eine Schneide gezahnt
one toothed cutting edge
una hoja dentada
une lame dentelée
una lama dentata



Wagner
PST-02-509 - PST-02-510
12 cm / 4 6/8"

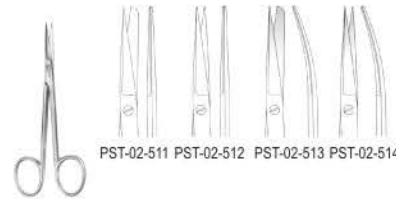

PST-02-511 - PST-02-514
12 cm / 4 6/8"

Zahnfleischscheren, Chirurgische Scheren

Gum Scissors, Operating Scissors
Tijeras para encías, Tijeras quirúrgicas
Ciseaux à gencives, Ciseaux chirurgicaux
Forbici per gengiva, Forbici per chirurgia



La Grange
PST-02-515
11,5 cm / 4 4/8"
S-Form
S-shape
forma S
courbé en S
curvo in forma S



PST-02-516 - PST-02-517
9 cm / 3 4/8"
sehr fein
very delicate
muy fino
très fin
strafino



Locklin
PST-02-520
16 cm / 6 2/8"

eine Schneide gezahnt
one toothed cutting edge
una hoja dentada
une lame dentelée
una lama dentata

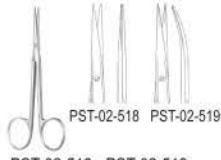

PST-02-518 - PST-02-519
11,5 cm / 4 4/8"
fein
delicate
fino
fin
fino



Locklin
PST-02-521
16 cm / 6 2/8"
S-Form
S-shape
forma S
courbé en S
curvo in forma S

eine Schneide gezahnt
one toothed cutting edge
una hoja dentada
une lame dentelée
una lama dentata

Irisscheren

Iris Scissors
Tijeras para iridectomía
Ciseaux à iridectomie
Forbici per iridectomia

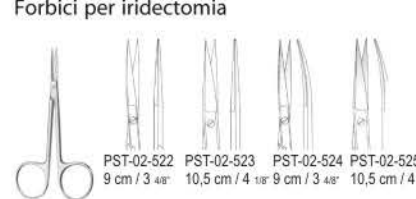

Mod. Bonn
PST-02-526
9 cm / 3 4/8"



PST-02-527
10,5 cm / 4 1/8"
extra flache Blätter
extra flat blades
hojas muy delgadas
lames extrêmement plates
con lame molto piate



Mod. Bonn
PST-02-528
9 cm / 3 4/8"



Scheren Scissors
Tijeras Tijeras
Ciseaux Ciseaux
Forbic Forbic 02



Quality Instruments

Irisscheren

Iris Scissors
Tijeras para iridectomia
Ciseaux à iridectomie
Forbici per iridectomia

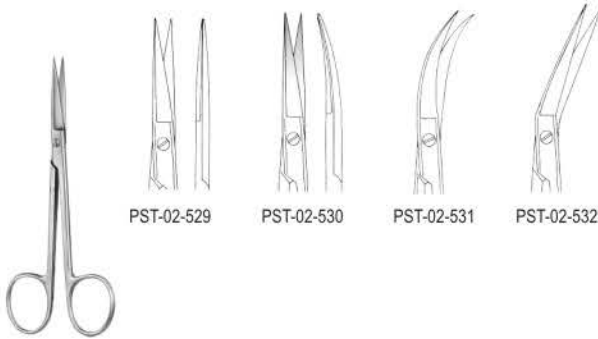

PST-02-529 - PST-02-532
11,5 cm / 4 1/8"

Irisscheren, Sehnenscheren

Iris Scissors, Tendon Scissors
Tijeras para iridectomia, Tijeras para tendones
Ciseaux à iridectomie, Ciseaux à ténotomie
Forbici per iridectomia, Forbici per tenotomia



PST-02-533 - PST-02-534
12,5 cm / 4 7/8"

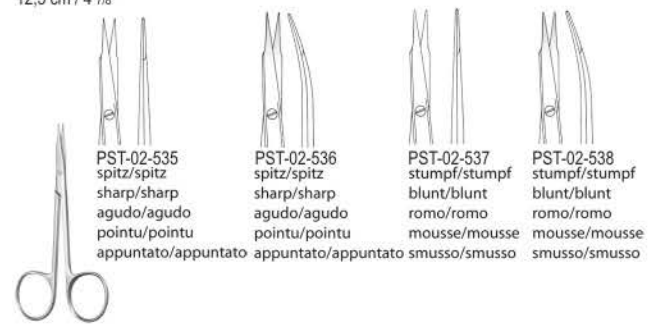

Stevens
PST-02-535 - PST-02-538
11 cm / 4 3/8"

Strabismusscheren

Strabismus Scissors
Tijeras para estrabismo
Ciseaux à strabisme
Forbici per strabismo



PST-02-539 - PST-02-540
11,5 cm / 4 1/8"

PST-02-541
11,5 cm / 4 1/8"
Enucleationsschere
Enucleation Scissors
Tijera para enucleación
Ciseaux à énucléation
Forbici per enucleazione

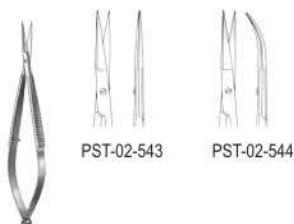

Westcott
PST-02-543 - PST-02-544
11,5 cm / 4 1/8"

Mikroscheren

Micro Scissors
Micro-Tijeras
Micro-Ciseaux
Micro-Forbici

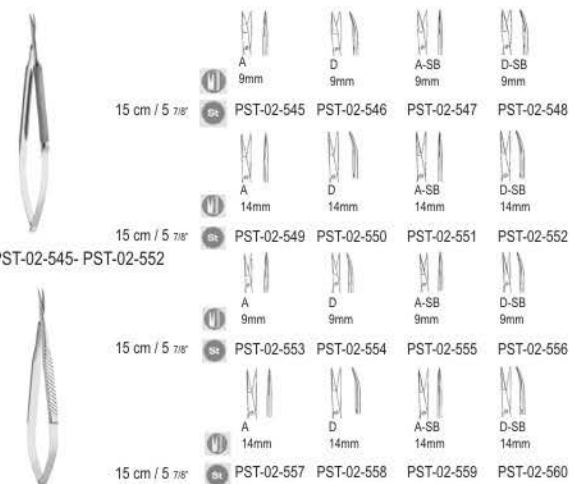

PST-02-553 - 560

A = Adventitia	D = Dissection	A = Adventice	D = Dissection
A-SB = Adventitia, ein gezahntes Blatt	A-SB = Adventitia, one serrated blade	A-SB = Adventice, une lame dentelée	A-SB = Adventice, une lame dentelée
D-SB = Präparation, ein gezahntes Blatt	D-SB = Dissection, one serrated blade	D-SB = Dissection, une lame dentelée	D-SB = Dissection, une lame dentelée
A = Adventicia	D = Dissección	A = Avventizia	D = Dissezione
A-SB = Adventicia, una hoja dentada	A-SB = Adventicia, una hoja dentada	A-SB = Avventizia, una lama dentata	A-SB = Avventizia, una lama dentata
D-SB = Dissección, una hoja dentada	D-SB = Dissección, una hoja dentada	D-SB = Dissezione, una lama dentata	D-SB = Dissezione, una lama dentata

Scheren
Scissors
Tijeras
Ciseaux
Forbic
02



Quality Instruments

Mikroscheren

Micro Scissors
Micro-Tijeras
Micro-Ciseaux
Micro-Forbici

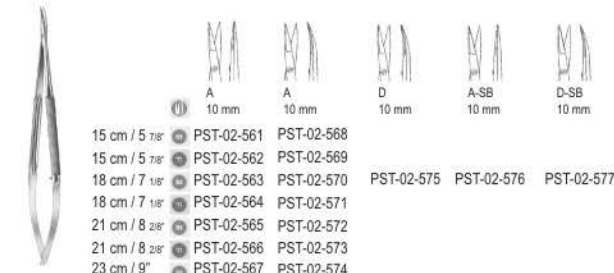

A 10 mm A 10 mm D 10 mm A-SB 10 mm D-SB 10 mm
 15 cm / 5 7/8" PST-02-561 PST-02-568
 15 cm / 5 7/8" PST-02-562 PST-02-569
 18 cm / 7 1/8" PST-02-563 PST-02-570 PST-02-575 PST-02-576 PST-02-577
 18 cm / 7 1/8" PST-02-564 PST-02-571
 21 cm / 8 2/8" PST-02-565 PST-02-572
 21 cm / 8 2/8" PST-02-566 PST-02-573
 23 cm / 9" PST-02-567 PST-02-574

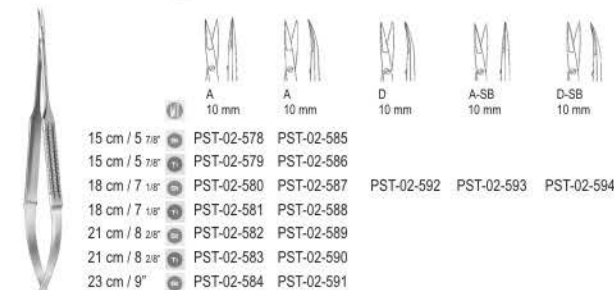

A 10 mm A 10 mm D 10 mm A-SB 10 mm D-SB 10 mm
 15 cm / 5 7/8" PST-02-578 PST-02-585
 15 cm / 5 7/8" PST-02-579 PST-02-586
 18 cm / 7 1/8" PST-02-580 PST-02-587 PST-02-592 PST-02-593 PST-02-594
 18 cm / 7 1/8" PST-02-581 PST-02-588
 21 cm / 8 2/8" PST-02-582 PST-02-589
 21 cm / 8 2/8" PST-02-583 PST-02-590
 23 cm / 9" PST-02-584 PST-02-591

A = Adventitia A = Adventitia A = Adventitia A = Adventitia
 D = Präparation D = Dissection D = Discción D = Dissection
 A-SB = Adventitia, ein gezahntes Blatt A-SB = Adventitia, one serrated blade A-SB = Adventitia, una hoja dentada A-SB = Adventitia, une lame dentée
 D-SB = Präparation, ein gezahntes Blatt D-SB = Dissection, one serrated blade D-SB = Discción, una hoja dentada D-SB = Dissection, une lame dentée



Mikroscheren

Micro Scissors
Micro-Tijeras
Micro-Ciseaux
Micro-Forbici

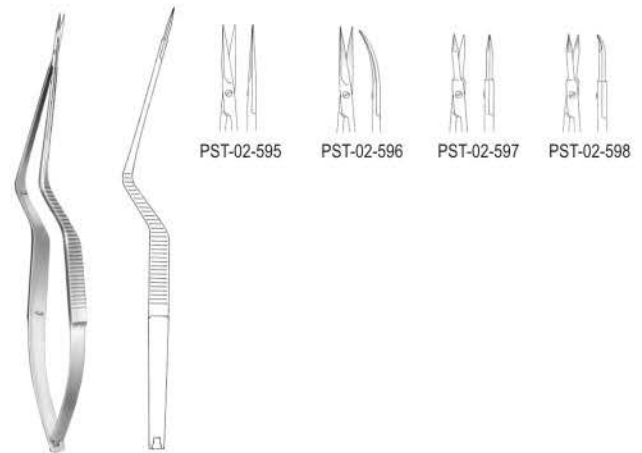

Jacobson
PST-02-595 - PST-02-598
20.5 cm / 8 1/8"



Mikroscheren

Micro Scissors
Micro-Tijeras
Micro-Ciseaux
Micro-Forbici

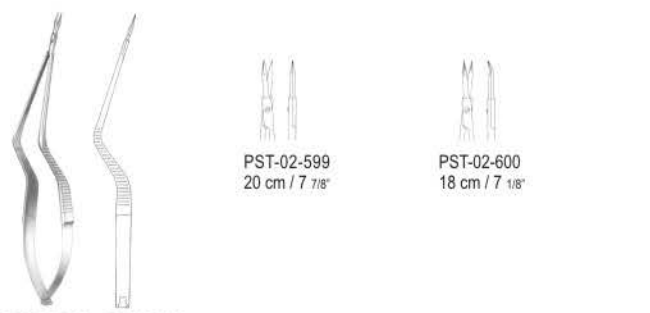

PST-02-599 PST-02-600
 20 cm / 7 7/8" 18 cm / 7 1/8"

PST-02-599 - PST-02-600

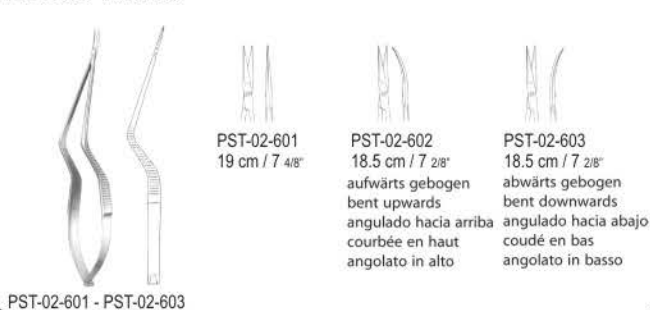

PST-02-601 PST-02-602 PST-02-603
 19 cm / 7 4/8" 18.5 cm / 7 2/8" 18.5 cm / 7 2/8"

aufwärts gebogen
bent upwards
angulado hacia arriba
courbée en haut
angolato in alto

abwärts gebogen
bent downwards
angulado hacia abajo
coudé en bas
angolato in basso

PST-02-601 - PST-02-603



Mikroscheren, Mikro-Präparierscheren

Micro Scissors, Micro Dissecting Scissors
Micro-Tijeras, Micro-Tijeras de disección
Micro-Ciseaux, Micro-Ciseaux à dissection
Micro-Forbici, Micro-Forbici per dissezione

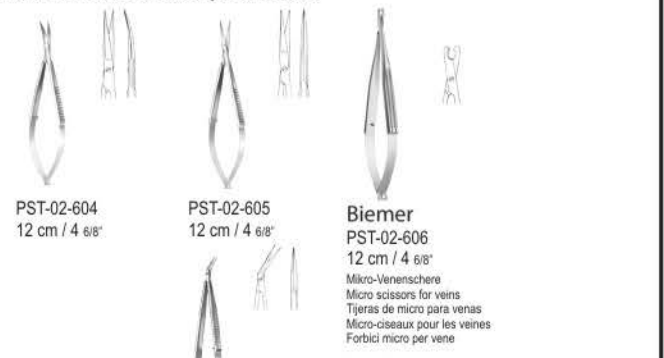

PST-02-604 PST-02-605
 12 cm / 4 6/8" 12 cm / 4 6/8"

PST-02-604 PST-02-605



PST-02-607
9.5 cm / 3 6/8"

Biemer
PST-02-606
12 cm / 4 6/8"

Mikro-Venenschere
Micro scissors for veins
Tijeras de micro para venas
Micro-ciseaux pour les veines
Forbici micro per vene

Zum Auffrischen von Gefäßslümpfen. Kein Abgleiten des Gefäßes und glatte, saubere Durchtrennung
 For roughening vessel ends, vessel cannot slip off, clean, smooth cut
 Renovación de extremos vasculares. Ningún resbalamiento del vaso, cortes limpios y lisos
 Pour rafraîchir des moignons vasculaires. Les vaisseaux ne peut pas glisser, coupe lisse et propre
 Per cuarentare le estremità vasili. Senza scivolamento del vaso, con distacco preciso

PST-02-606



Scheren
Scissors
Tijeras
Ciseaux
Forbici



Quality Instruments

Mikroscheren

Micro Scissors
Micro-Tijeras
Micro-Ciseaux
Micro-Forbici

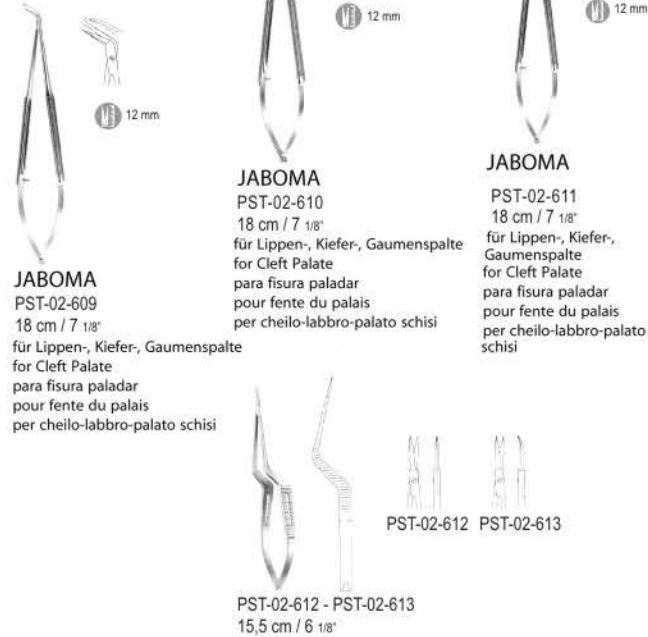

JABOMA
PST-02-609
18 cm / 7 1/8"
für Lippen-, Kiefer-, Gaumenspalte
for Cleft Palate
para fisura paladar
pour fente du palais
per cheilo-labbro-palato schisi

JABOMA
PST-02-610
18 cm / 7 1/8"
für Lippen-, Kiefer-, Gaumenspalte
for Cleft Palate
para fisura paladar
pour fente du palais
per cheilo-labbro-palato schisi

JABOMA
PST-02-611
18 cm / 7 1/8"
für Lippen-, Kiefer-, Gaumenspalte
for Cleft Palate
para fisura paladar
pour fente du palais
per cheilo-labbro-palato schisi

PST-02-612 - PST-02-613
15,5 cm / 6 1/8"

Darmscheren

Enterotomy Scissors
Tijeras para intestino
Ciseaux-entérotomes
Forbici per enterotomia

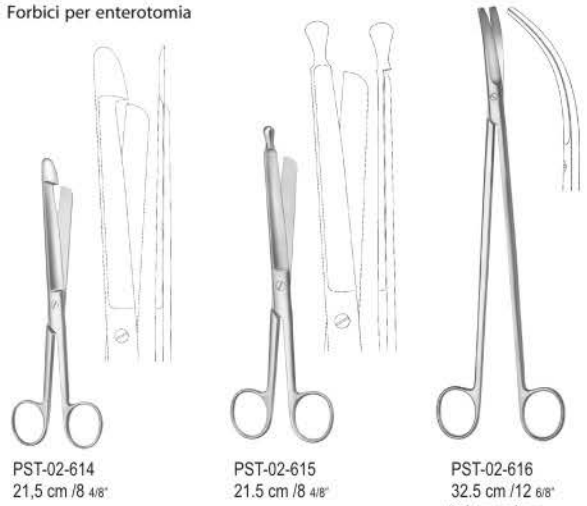

PST-02-614
21,5 cm / 8 4/8"

PST-02-615
21.5 cm / 8 4/8"

PST-02-616
32.5 cm / 12 6/8"
Rektumschere
Rectal Scissors
Tijera para recto
Ciseaux pour rectum
Forbici per il retto

Präparierscheren, Face-lift-Scheren, Fadenscheren

Dissecting Scissors, Face-lift Scissors, Stitch Scissors
Tijeras de disección, Tijeras para Face-Lift, Tijeras para hilos
Ciseaux à dissection, Ciseaux pour Face-lift, Ciseaux à ligatures
Forbici per dissezione, Forbici per Face-lift, Forbici per legature

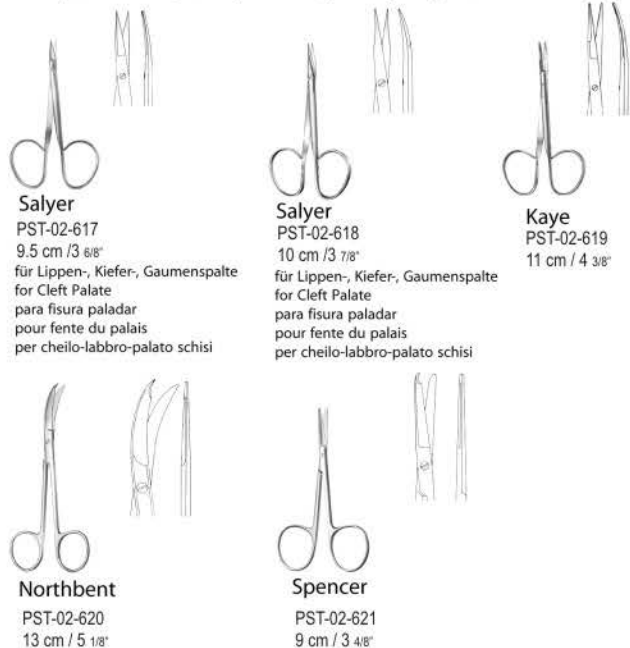

Salyer
PST-02-617
9.5 cm / 3 6/8"
für Lippen-, Kiefer-, Gaumenspalte
for Cleft Palate
para fisura paladar
pour fente du palais
per cheilo-labbro-palato schisi

Salyer
PST-02-618
10 cm / 3 7/8"
für Lippen-, Kiefer-, Gaumenspalte
for Cleft Palate
para fisura paladar
pour fente du palais
per cheilo-labbro-palato schisi

Kaye
PST-02-619
11 cm / 4 3/8"

Northbent
PST-02-620
13 cm / 5 1/8"

Spencer
PST-02-621
9 cm / 3 4/8"

Fadenscheren

Stitch Scissors
Tijeras para hilos
Ciseaux à ligatures
Forbici per legature

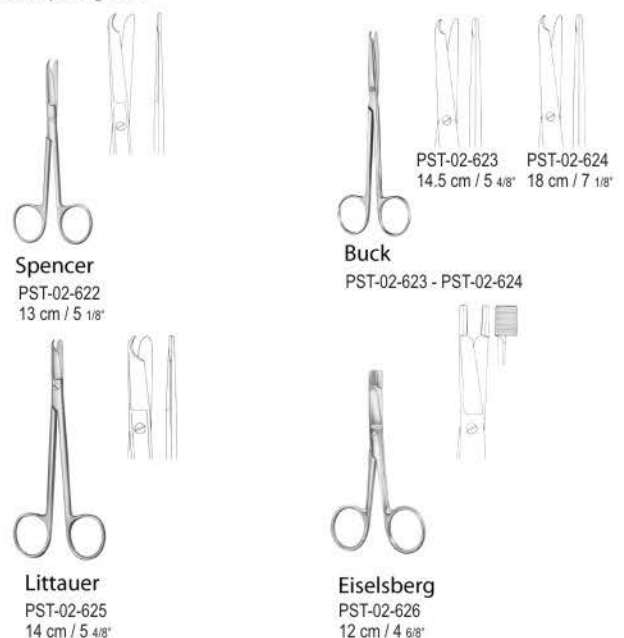

Spencer
PST-02-622
13 cm / 5 1/8"

PST-02-623
14.5 cm / 5 4/8"

PST-02-624
18 cm / 7 1/8"

Buck
PST-02-623 - PST-02-624

Littauer
PST-02-625
14 cm / 5 4/8"

Eiselsberg
PST-02-626
12 cm / 4 6/8"

Scheren
Scissors
Tijeras
Ciseaux
Forbic



Quality Instruments

Drahtscheren

Wire Cutting Scissors
Tijeras para cortar hilos de acero
Ciseaux coupe-fil
Forbici per tagliare fili metallici



Universal
PST-02-627
12 cm / 4 6/8"

eine Schneide gezahnt
one toothed cutting edge
una hoja dentada
une lame dentelée
una lama dentata

für weiche Drähte bis Ø 0,4 mm
for soft wires up to Ø 0.4 mm
para alambres blandos hasta Ø 0,4 mm
pour fils mous jusqu'à Ø 0,4 mm
per fili molli fina a Ø 0,4 mm

Beebee
PST-02-628 - PST-02-631

eine Schneide gezahnt
one toothed cutting edge
una hoja dentada
une lame dentelée
una lama dentata

Aquila-Scheren

Aquila-Scissors
Tijeras Aquila
Ciseaux Aquila
Forbici Aquila

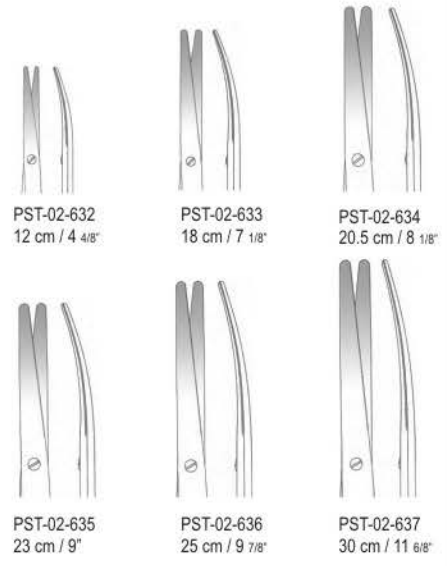

PST-02-632
12 cm / 4 4/8"

PST-02-633
18 cm / 7 1/8"

PST-02-634
20.5 cm / 8 1/8"

PST-02-635
23 cm / 9"

PST-02-636
25 cm / 9 7/8"

PST-02-637
30 cm / 11 6/8"

Metzenbaum-Aquila
PST-02-632 - PST-02-637

eine Schneide gezahnt / eine Schneide mit Messerschiff
one toothed cutting edge / one cutting edge with knife cut
una hoja dentada / una hoja con afilado de cuchillo
une lame dentelée / une lame avec taille de couteau
una lama dentata / una lama con affilatura di coltello

Aquila-Scheren

Aquila-Scissors
Tijeras Aquila
Ciseaux Aquila
Forbici Aquila

TC GOLD



PST-02-638
14 cm / 5 4/8"

PST-02-639
18 cm / 7 1/8"

Mayo-Lexer-Aquila
PST-02-641
17.5 cm / 6 7/8"

Tönnis-Adson-Aquila
PST-02-640
17.5 cm / 7"

Metzenbaum-Aquila
PST-02-638 - PST-02-639
eine Schneide gezahnt /
eine Schneide mit Messerschiff
one toothed cutting edge /
one cutting edge with knife cut
una hoja dentada /
una hoja con afilado de cuchillo
une lame dentelée /
une lame avec taille de couteau
una lama dentata /
una lama con affilatura di coltello

Chirurgische Scheren

Operating Scissors
Tijeras quirúrgicas
Ciseaux chirurgicaux
Forbici per chirurgia

TC GOLD



PST-02-642

PST-02-643

PST-02-644

PST-02-642 - PST-02-644
14.5 cm / 5 3/8"

PST-02-645

PST-02-646

PST-02-647

PST-02-645 - PST-02-647
14.5 cm / 5 3/8"



Scheren Scissors
Tijeras Tijeras
Ciseaux Ciseaux
Forbic Forbic 02



Quality Instruments

Chirurgische Scheren

Operating Scissors
Tijeras quirúrgicas
Ciseaux chirurgicaux
Forbici per chirurgia

TC GOLD



PST-02-648
14.5 cm / 5 3/4"



PST-02-649
17 cm / 6 3/4"

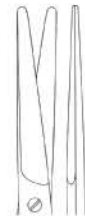

PST-02-650
23 cm / 9"

Mayo

PST-02-648 - PST-02-650



PST-02-651
14.5 cm / 5 3/4"



PST-02-652
17 cm / 6 3/4"



PST-02-653
23 cm / 9"

Mayo

PST-02-651 - PST-02-653



Präparierscheren

Dissecting Scissors
Tijeras de disección
Ciseaux à dissection
Forbici per dissezione

TC GOLD



PST-02-654
14.5 cm / 5 6/8"



PST-02-655
17 cm / 6 6/8"

Mayo-Stillle

PST-02-654 - PST-02-655



PST-02-656
14.5 cm / 5 6/8"



PST-02-657
17 cm / 6 6/8"

Mayo-Stillle

PST-02-656 - PST-02-657



Präparierscheren

Dissecting Scissors
Tijeras de disección
Ciseaux à dissection
Forbici per dissezione

TC GOLD



PST-02-658
11.5 cm / 4 4/8"



PST-02-659
14.5 cm / 5 6/8"

Metzenbaum

PST-02-658 - PST-02-659



PST-02-660
11.5 cm / 4 4/8"



PST-02-661
14.5 cm / 5 6/8"

Metzenbaum

PST-02-660 - PST-02-661



Präparierscheren

Dissecting Scissors
Tijeras de disección
Ciseaux à dissection
Forbici per dissezione

TC GOLD



PST-02-662
18 cm / 7 1/8"



PST-02-663
20.5 cm / 8 1/8"



PST-02-664
23 cm / 9"



PST-02-665
26 cm / 10 2/8"



PST-02-666
28.5 cm / 11 2/8"



PST-02-667
31 cm / 12 2/8"

Metzenbaum

PST-02-662 - PST-02-667



Scheren
Scissors
Tijeras
Ciseaux
Forbic

02



Quality Instruments

Präparierscheren

Dissecting Scissors
Tijeras de disección
Ciseaux à dissection
Forbici per dissezione

TC GOLD



PST-02-668
18 cm / 7 1/8"



PST-02-669
20.5 cm / 8 1/8"



PST-02-670
23 cm / 9"



Metzenbaum

PST-02-668 - PST-02-673



PST-02-671
26 cm / 10 2/8"



PST-02-672
28.5 cm / 11 2/8"



PST-02-673
31 cm / 12 2/8"



Präparierscheren, Chirurgische Scheren

Dissecting Scissors, Operating Scissors
Tijeras de disección, Tijeras quirúrgicas
Ciseaux à dissection, Ciseaux chirurgicaux
Forbici per dissezione, Forbici per chirurgia

TC GOLD



Metzenbaum-Thorek

PST-02-674 - PST-02-676



PST-02-674
20 cm / 7 7/8"



PST-02-675
23 cm / 9"



PST-02-676
28 cm / 11"



Joseph

PST-02-677 - PST-02-678



PST-02-677
14.5 cm / 5 6/8"



PST-02-678
14.5 cm / 5 6/8"



Chirurgische Scheren, Präparierscheren

Operating Scissors, Dissecting Scissors
Tijeras quirúrgicas, Tijeras de disección
Ciseaux chirurgicaux, Ciseaux à dissection
Forbici per chirurgia, Forbici per dissezione

TC GOLD



Lexer

PST-02-679 - PST-02-680



PST-02-679
16 cm / 6 2/8"

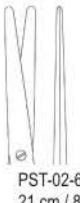

PST-02-680
21 cm / 8 2/8"



Lexer

PST-02-681 - PST-02-682



PST-02-681
16 cm / 6 2/8"



PST-02-682
21 cm / 8 2/8"



Mayo-Lexer

PST-02-683
16 cm / 6 2/8"



Feine Präparierscheren

Delicate Dissecting Scissors
Tijeras finas de disección
Ciseaux fins à dissection
Forbici fini per dissezione

TC GOLD



Metzenbaum-Fino

PST-02-684 - PST-02-685
14.5 cm / 5 6/8"



PST-02-684



PST-02-685



Metzenbaum-Fino

PST-02-686 - PST-02-687
14.5 cm / 5 6/8"



PST-02-686



PST-02-687



Metzenbaum-Fino

PST-02-688 - PST-02-689
18 cm / 7 1/8"



PST-02-688



PST-02-689



Scheren Scissors
Tijeras Tijeras
Ciseaux Ciseaux
Forbic Forbic 02



Quality Instruments

Feine Präparierscheren

Delicate Dissecting Scissors
Tijeras finas de disección
Ciseaux fins à dissection
Forbici fini per dissezione

TC GOLD

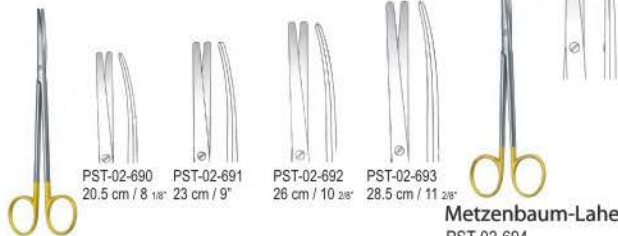

PST-02-690 20.5 cm / 8 1/8" 23 cm / 9"
PST-02-691
PST-02-692 26 cm / 10 2/8"
PST-02-693 28.5 cm / 11 2/8"

Metzenbaum-Lahey

PST-02-694
14.5 cm / 5 6/8"

schlankes Modell
slender pattern
modelo delgado
modèle gracile
modello delicato

Metzenbaum-Fino

PST-02-690 - PST-02-693

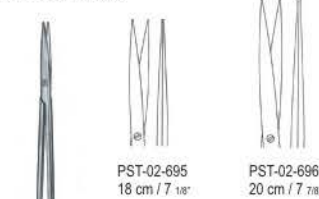

PST-02-695 18 cm / 7 1/8"
PST-02-696 20 cm / 7 7/8"

Metzenbaum-Fino

PST-02-695 - PST-02-696

Feine Präparierscheren

Delicate Dissecting Scissors
Tijeras finas de disección
Ciseaux fins à dissection
Forbici fini per dissezione

TC GOLD



PST-02-698
2.5 cm / 8 1/8"

PST-02-699
23 cm / 9"

Toennis-Adson

PST-02-697
17.5 cm / 6 7/8"

schlankes Modell
slender pattern
modelo delgado
modèle gracile
modello delicato



Metzenbaum-Fino

PST-02-698 - PST-02-699

schlankes Modell
slender pattern
modelo delgado
modèle gracile
modello delicato



PST-02-700 18 cm / 7 1/8" PST-02-701 20 cm / 7 7/8" PST-02-702 23 cm / 9"

Metzenbaum-Fino

PST-02-700 - PST-02-702

schlankes Modell
slender pattern
modelo delgado
modèle gracile
modello delicato



Face-lift-Scheren

Face-lift Scissors
Tijeras para Face-Lift
Ciseaux pour Face-lift
Forbici per Face-lift

TC GOLD



PST-02-703
20 cm / 7 7/8"

PST-02-704
18 cm / 9"

Gorney

PST-02-703 - PST-02-704

eine Schneide gezahnt
one toothed cutting edge
una hoja dentada
une lame dentelée
una lama dentata



Rees

PST-02-705

17 cm / 6 6/8"
eine Schneide gezahnt
one toothed cutting edge
una hoja dentada
une lame dentelée
una lama dentata

Aquila-Scheren

Aquila Scissors
Tijeras Aquila
Ciseaux Aquila
Forbici Aquila

TC GOLD

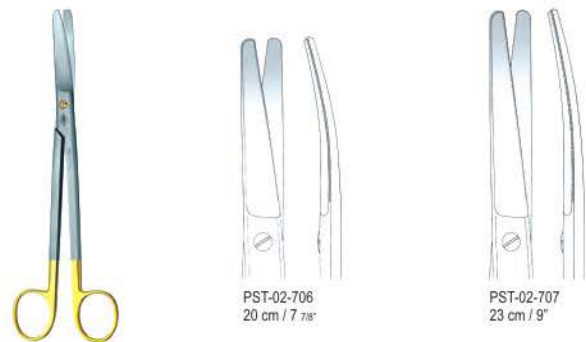

PST-02-706
20 cm / 7 7/8"

PST-02-707
23 cm / 9"

Sims-Aquila

PST-02-706 - PST-02-707

Uterusschere
Uterine Scissors
Tijera uterina
Ciseaux utérins
Forbici per utero
eine Schneide gezahnt / eine Schneide Messerschliiff
one toothed cutting edge / one cutting edge knife cut
una hoja dentada / una hoja con afilado de cuchillo
une lame dentelée / une lame avec taille de couteau
una lama dentata / una lama con affilatura di coltello



Scheren
Scissors
Tijeras
Ciseaux
Forbic

02



Quality Instruments

Uterusscheren

Uterine Scissors
Tijeras uterinas
Ciseaux utérins
Forbici uterine

TC GOLD

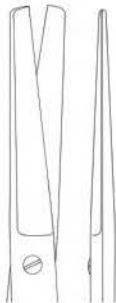

PST-02-708

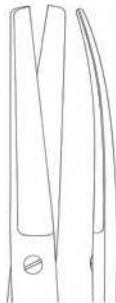

PST-02-709

Sims

PST-02-708 - PST-02-709
23 cm / 9"

Hysterektomiescheren

Hysterectomy Scissors
Tijeras para histerectomia
Ciseaux à hystérectomie
Forbici per isterectomia

TC GOLD

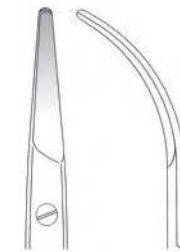

PST-02-710
22 cm / 8 5/8"

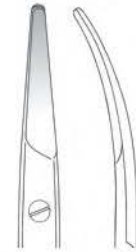

PST-02-711
23 cm / 9"

PST-02-710 - PST-02-711
kräftiges Modell
heavy pattern
modelo fuerte
modèle fort
modello forte



Ligaturscheren, Irisscheren

Ligature Scissors, Iris Scissors
Tijeras para ligaduras, Tijeras para iridectomia
Ciseaux pour ligatures, Ciseaux à iridectomie
Forbici per legature, Forbici per iridectomia

TC GOLD



PST-02-712



PST-02-713

Goldmann-Fox

PST-02-712 - PST-02-713
13 cm / 5 1/8"

eine Schneide gezahnt
one toothed cutting edge
una hoja dentada
une lame dentelée
una lama dentata



PST-02-714
11.5 cm / 4 5/8"



PST-02-715
11.5 cm / 4 5/8"

Winkelscheren

Angled Scissors
Tijeras acodadas
Ciseaux coudés
Forbici angolate

TC GOLD



PST-02-716
19 cm / 7 4/8"



PST-02-717
18.5 cm / 7 2/8"



PST-02-718
18 cm / 7 1/8"



PST-02-719
23 cm / 9"



PST-02-720
23 cm / 9"



PST-02-721
22 cm / 8 2/8"



De Bakey
PST-02-716 - PST-02-721



PST-02-722
11 cm / 4 3/8"



Scheren
Scissors
Tijeras
Ciseaux
Forbic 02



Quality Instruments

Aquila-Scheren

Aquila Scissors
Tijeras Aquila
Ciseaux Aquila
Forbici Aquila

TC **GOLD**

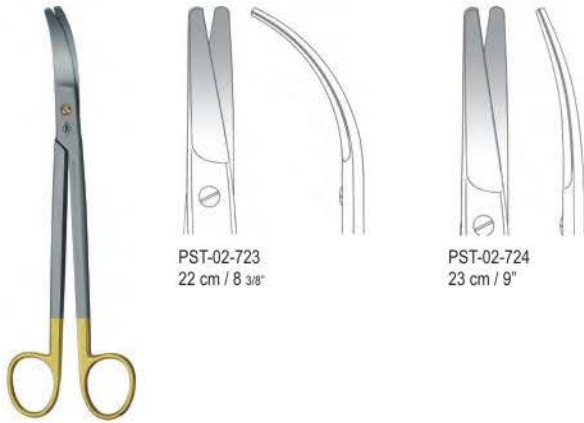

PST-02-723
22 cm / 8 3/8"

PST-02-724
23 cm / 9"

PST-02-723 - PST-02-724
Hysterektomieschere
Hysterectomy Scissors
Tijera para histerectomía
Ciseaux à hystérectomie
Forbici per isterectomia

Präparierscheren, Chirurgische Scheren

Dissecting Scissors, Operating Scissors
Tijeras de disección, Tijeras quirúrgicas
Ciseaux à dissection, Ciseaux chirurgicaux
Forbici per dissezione, Forbici per chirurgia

TC **GOLD**



Ragnell

PST-02-725
12.5 cm / 4 7/8"

Kelly

PST-02-726 - PST-02-727

PST-02-726
16 cm / 6 2/8"

PST-02-727
16 cm / 6 2/8"



Tonsillenscheren, Drahtscheren

Tonsil Scissors, Wire Cutting Scissors
Tijeras para amígdalas, Tijeras para cortar hilos de acero
Ciseaux pour les amygdales, Ciseaux coupe-fil
Forbici per tonsille, Forbici per tagliare fili metallici

TC **GOLD**

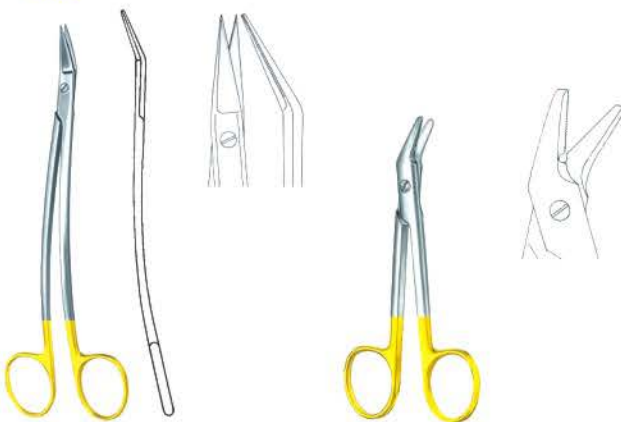

Dean

PST-02-728
17.5 cm / 6 7/8"

eine Schneide gezahnt
one toothed cutting edge
una hoja dentada
une lame dentelée
una lama dentata

Universal

PST-02-729
12.5 cm / 4 7/8"

eine Schneide gezahnt
one toothed cutting edge
una hoja dentada
une lame dentelée
una lama dentata



Zahnfleischscheren

Gum Scissors
Tijeras para encías
Ciseaux à gencives
Forbici per gengiva

TC **GOLD**



Locklin

PST-02-730
16 cm / 6 2/8"

eine Schneide gezahnt
one toothed cutting edge
una hoja dentada
une lame dentelée
una lama dentata

Locklin

PST-02-731
16 cm / 6 2/8"

eine Schneide gezahnt
one toothed cutting edge
una hoja dentada
une lame dentelée
una lama dentata



Pinzetten
Forceps
Pinzas
Pinces
Pinze



03

26 - 34

Arterienklemmen
Artery Forceps
Pinzas Hemostaticas
Pinces Hemostatiques
Pinze emostatiche

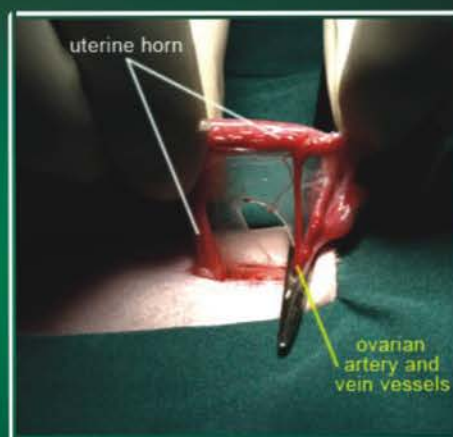

04

35 - 48

Tupfer and kornzeggen
Cotton Swep Forceps etc
Pinzas Para tapones y- curaciones
Pinces Tampons et à Pansements
Pinze per Tamponi e per Medicazione



05

49 - 50

Pinzetten
 Forceps
 Pinzas
 Pincas
 Pinze

03



Quality Instruments

Anatomische Pinzetten

Dissecting Forceps
 Pinzas de disección
 Pincas à dissection
 Pinze per dissezione

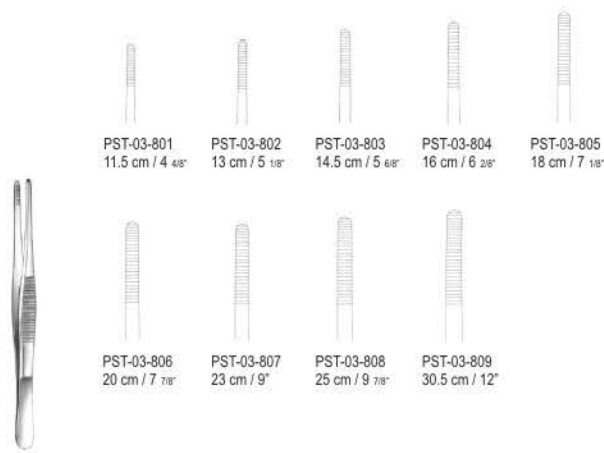

PST-03-801 11.5 cm / 4 1/2"
 PST-03-802 13 cm / 5 1/8"
 PST-03-803 14.5 cm / 5 3/8"
 PST-03-804 16 cm / 6 2/8"
 PST-03-805 18 cm / 7 1/8"

PST-03-806 20 cm / 7 7/8"
 PST-03-807 23 cm / 9"
 PST-03-808 25 cm / 9 7/8"
 PST-03-809 30.5 cm / 12"

PST-03-801 - PST-03-809
 Standardmodell
 standard pattern
 modelo estándar
 modèle standard
 modello standard

Anatomische Pinzetten

Dissecting Forceps
 Pinzas de disección
 Pincas à dissection
 Pinze per dissezione

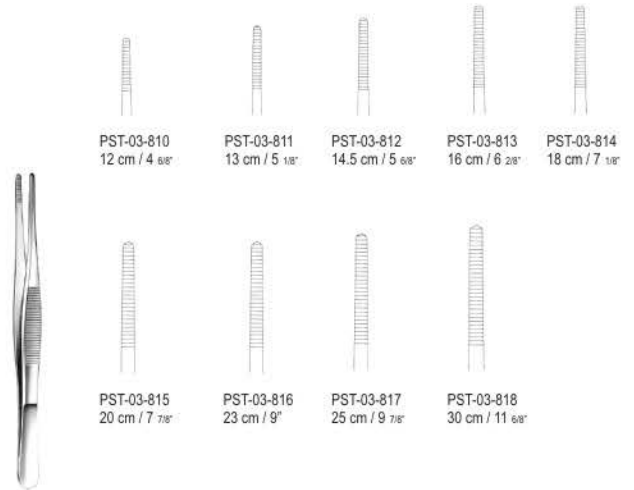

PST-03-810 12 cm / 4 3/8"
 PST-03-811 13 cm / 5 1/8"
 PST-03-812 14.5 cm / 5 3/8"
 PST-03-813 16 cm / 6 2/8"
 PST-03-814 18 cm / 7 1/8"

PST-03-815 20 cm / 7 7/8"
 PST-03-816 23 cm / 9"
 PST-03-817 25 cm / 9 7/8"
 PST-03-818 30 cm / 11 3/8"

PST-03-810 - PST-03-818
 mittelbreit
 medium width
 de anchura medio
 demi-large
 di media larghezza



Anatomische Pinzetten

Dissecting Forceps
 Pinzas de disección
 Pincas à dissection
 Pinze per dissezione

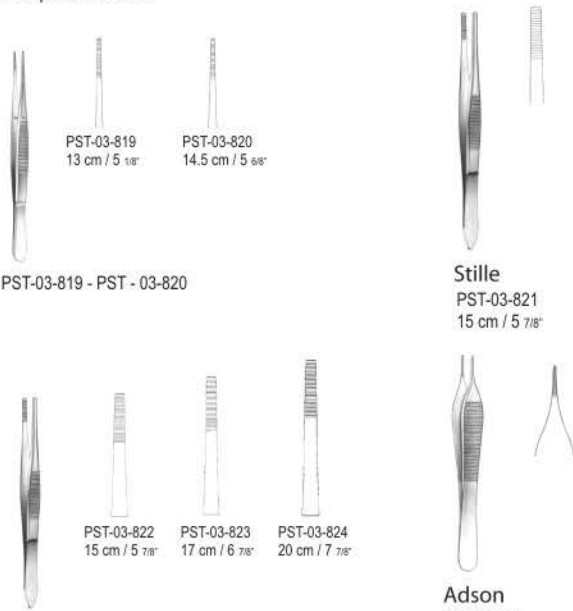

PST-03-819 13 cm / 5 1/8"
 PST-03-820 14.5 cm / 5 3/8"

PST-03-819 - PST - 03-820

Stille
 PST-03-821
 15 cm / 5 7/8"

PST-03-822 15 cm / 5 7/8"
 PST-03-823 17 cm / 6 7/8"
 PST-03-824 20 cm / 7 7/8"

PST-03-822 - PST-03-824

Adson
 PST-03-825
 12 cm / 4 3/8"



Anatomische Pinzetten

Dissecting Forceps
 Pinzas de disección
 Pincas à dissection
 Pinze per dissezione

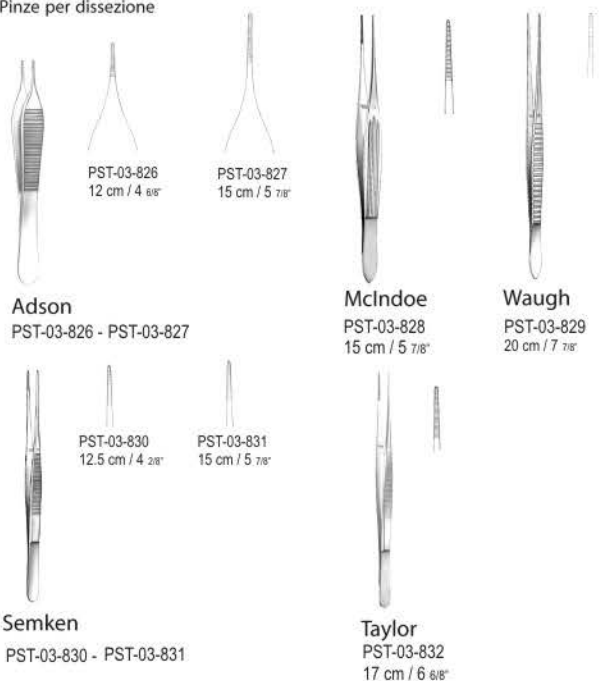

PST-03-826 12 cm / 4 3/8"
 PST-03-827 15 cm / 5 7/8"

Adson
 PST-03-826 - PST-03-827

McIndoe
 PST-03-828
 15 cm / 5 7/8"

Waugh
 PST-03-829
 20 cm / 7 7/8"

PST-03-830 12.5 cm / 4 2/8"
 PST-03-831 15 cm / 5 7/8"

Semken
 PST-03-830 - PST-03-831

Taylor
 PST-03-832
 17 cm / 6 3/8"



Pinzetten
 Forceps
 Pinzas
 Pincas
 Pinze

03



Quality Instruments

Anatomische Pinzetten

Dissecting Forceps
 Pinzas de disección
 Pincas à dissection
 Pinze per dissezione



Taylor

PST-03-833
 17.5 cm / 6 7/8"
 mit Schaberende
 with dissector end
 con rascador
 à rugine
 con estremita a forma di raschino



Taylor

PST-03-834
 18.5 cm / 7 2/8"
 mit Schaberende
 with dissector end
 con rascador
 à rugine
 con estremita a forma di raschino

Anatomische Mikropinzetten, Atraumatische Pinzetten

Micro Dissecting Forceps, Atraumatic Dissecting Forceps
 Micro Pinzas de disección, Pinzas de disección atraumática
 Micro-Pincas à dissection, Pincas atraumatiques à dissection
 Micro-Pinze per dissezione, Pinze atraumatiche



PST-03-835
 0.6 mm



PST-03-836
 0.8 mm



PST-03-837
 1.0 mm

PST-03-835 - PST-03-837
 15.5 cm / 6 1/8"



PST-03-838
 17.5 cm / 6 7/8"

Anatomische Pinzetten

Dissecting Forceps
 Pinzas de disección
 Pincas à dissection
 Pinze per dissezione



Gerald

PST-03-839 - PST-03-840



PST-03-839
 17.5 cm / 6 7/8"



PST-03-840
 17 cm / 6 6/8"



Cushing

PST-03-841 - PST-03-842



PST-03-841
 17.5 cm / 6 7/8"



PST-03-842
 17 cm / 6 6/8"



Potts-Smith

PST-03-843 - PST-03-846



PST-03-843
 18 cm / 7 1/8"



PST-03-844
 21 cm / 8 2/8"



PST-03-845
 25 cm / 9 7/8"



PST-03-846
 30 cm / 11 6/8"

Chirurgische Pinzetten, Anatomische Pinzetten

Tissue Forceps, Dissecting Forceps
 Pinzas de disección con diente, Pinzas de disección
 Pincas à dissection à griffes, Pincas à dissection
 Pinze per dissezione con denti, Pinze per dissezione

TC GOLD



Bonney

PST-03-847
 17.5 cm / 6 7/8"
 Normalprofil
 standard profile
 perfil estándar
 profil normal
 profilo normale



Gerald

PST-03-848
 17.5 cm / 6 7/8"
 Normalprofil
 standard profile
 perfil estándar
 profil normal
 profilo normale



Gillies

PST-03-849
 15.5 cm / 6 1/8"
 Miniprofil
 mini profile
 perfil mini
 profil mini
 mini-profilo



McIndoe

PST-03-850
 15 cm / 5 7/8"
 Miniprofil
 mini profile
 perfil mini
 profil mini
 mini-profilo

Pinzetten
 Forceps
 Pinzas
 Pincas
 Pinze

03



Quality Instruments

Chirurgische Pinzetten

Tissue Forceps
 Pinzas de disección con diente
 Pincas à dissection à griffes
 Pinze per dissezione con denti

TC GOLD

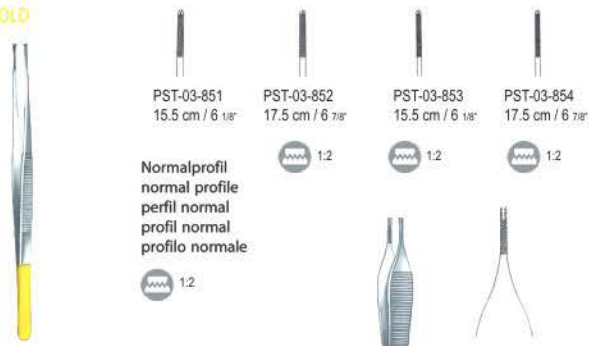

Semken
 PST-03-851 - PST-03-854

PST-03-851 15.5 cm / 6 1/8"
 PST-03-852 17.5 cm / 6 7/8"
 PST-03-853 15.5 cm / 6 1/8"
 PST-03-854 17.5 cm / 6 7/8"
 Normalprofil normal profile
 perfil normal profil normal
 profilo normale

Adson-Brown
 PST-03-855
 12 cm / 4 6/8"
 Normalprofil normal profile
 perfil normal profil normal
 profilo normale



Chirurgische Pinzetten, Anatomische Pinzetten

Tissue Forceps, Dissecting Forceps
 Pinzas de disección con diente, Pinzas de disección
 Pincas à dissection à griffes, Pincas à dissection
 Pinze per dissezione con denti, Pinze per dissezione

TC GOLD

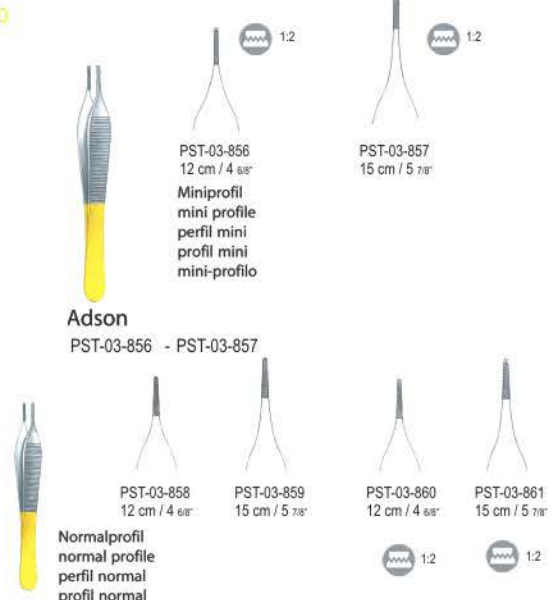

Adson
 PST-03-856 - PST-03-857

Adson
 PST-03-858 - PST-03-861

PST-03-856 12 cm / 4 6/8"
 Miniprofil mini profile
 perfil mini profil mini
 mini-profilo
 PST-03-857 15 cm / 5 7/8"
 PST-03-858 12 cm / 4 6/8"
 PST-03-859 15 cm / 5 7/8"
 PST-03-860 12 cm / 4 6/8"
 PST-03-861 15 cm / 5 7/8"
 Normalprofil normal profile
 perfil normal profil normal
 profilo normale



Anatomische Pinzetten

Dissecting Forceps
 Pinzas de disección
 Pincas à dissection
 Pinze per dissezione

TC GOLD



Cushing
 PST-03-862
 17.5 cm / 6 7/8"

Cushing
 PST-03-863
 17 cm / 6 6/8"

Cushing-Taylor
 PST-03-864
 18.5 cm / 7 2/8"

Normalprofil normal profile
 perfil normal profil normal
 profilo normale

PST-03-865 16 cm / 6 2/8"
 PST-03-866 18.5 cm / 7 2/8"
 PST-03-867 20 cm / 7 7/8"
 PST-03-868 23 cm / 9"
 PST-03-869 25 cm / 9 7/8"

Potts-Smith
 PST-03-865 - PST-03-869

Normalprofil normal profile
 perfil normal profil normal
 profilo normale



Chirurgische Pinzetten

Tissue Forceps
 Pinzas de disección con diente
 Pincas à dissection à griffes
 Pinze per dissezione con denti

TC GOLD

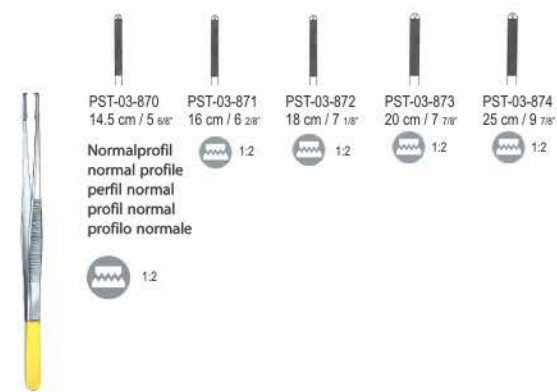

Oehler
 PST-03-870 - PST-03-874

PST-03-870 14.5 cm / 5 6/8"
 PST-03-871 16 cm / 6 2/8"
 PST-03-872 18 cm / 7 1/8"
 PST-03-873 20 cm / 7 7/8"
 PST-03-874 25 cm / 9 7/8"
 Normalprofil normal profile
 perfil normal profil normal
 profilo normale



Pinzetten
 Forceps
 Pinzas
 Pincas
 Pinze

03



Quality Instruments

Anatomische Pinzetten, Atraumatische Pinzetten

Dissecting Forceps, Atraumatic Dissecting Forceps
 Pinzas de disección, Pinzas de disección atraumática
 Pincas à dissection, Pincas atraumatiques à dissection
 Pinze per dissezione, Pinze atraumatiche

TC GOLD

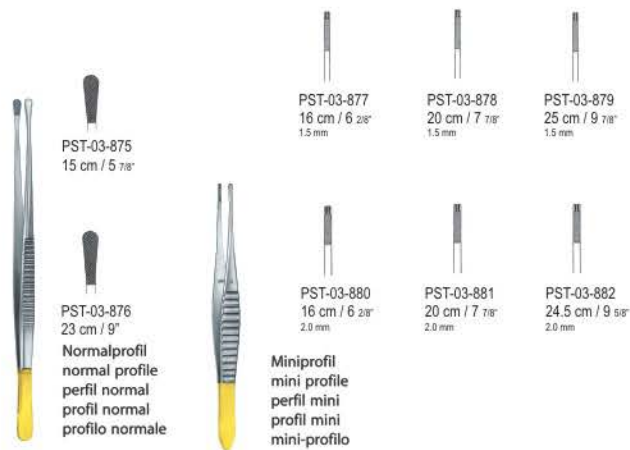

Wangensteen
 PST-03-875 - PST-03-876

De Bakey
 PST-03-877 - PST-03-882

Chirurgische Pinzetten, Anatomische Pinzetten

Dissecting Forceps, Tissue Forceps
 Pinzas de disección con diente, Pinzas de disección
 Pincas à dissection à griffes, Pincas à dissection
 Pinze per dissezione con denti, Pinze per dissezione

TC GOLD



JABOMA
 PST-03-883
 18 cm / 7 1/8"

JABOMA
 PST-03-884
 18 cm / 7 1/8"

JABOMA
 PST-03-885
 18 cm / 7 1/8"

Chirurgische Pinzetten

Tissue Forceps
 Pinzas de disección con diente
 Pincas à dissection à griffes
 Pinze per dissezione con denti

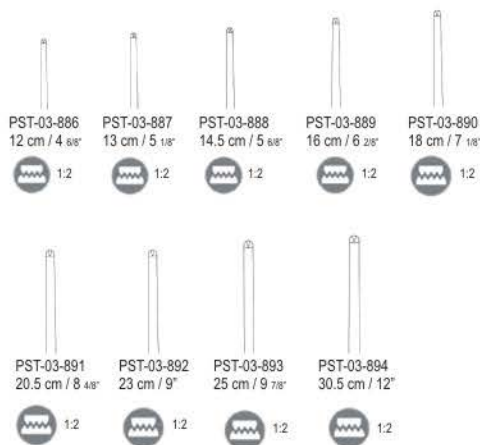

PST-03-886 - PST-03-894
 Standardmodell
 standard pattern
 modelo estándar
 modèle standard
 modello standard

Chirurgische Pinzetten

Tissue Forceps
 Pinzas de disección con diente
 Pincas à dissection à griffes
 Pinze per dissezione con denti

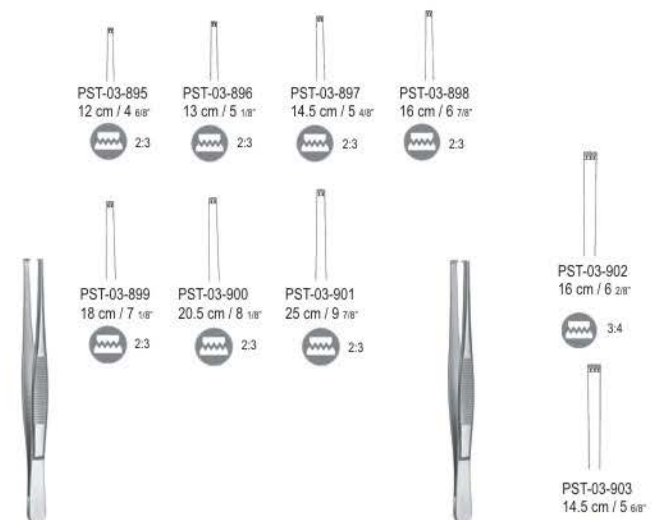

PST-03-895 - PST-03-901

PST-03-902 - PST-03-903

Pinzetten
 Forceps
 Pinzas
 Pincas
 Pinze

03



Quality Instruments

Chirurgische Pinzetten

Tissue Forceps
 Pinzas de disección con diente
 Pincas à dissection à griffes
 Pinze per dissezione con denti

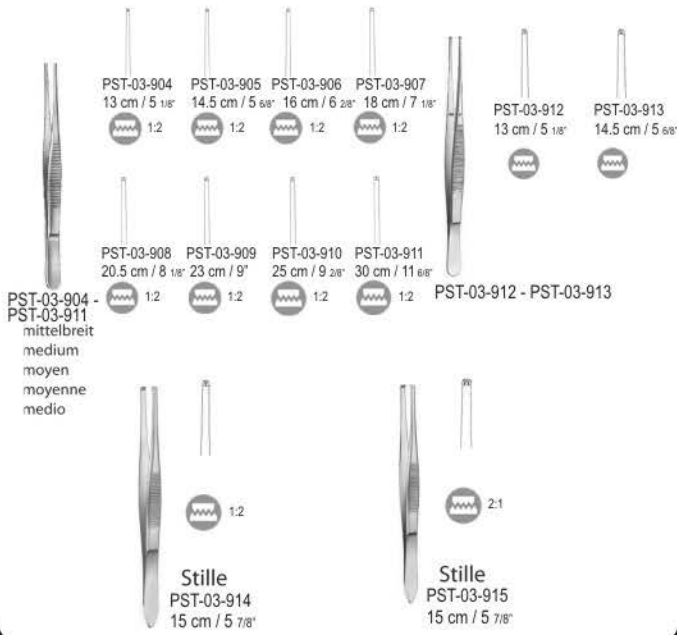

Chirurgische Pinzetten

Tissue Forceps
 Pinzas de disección con diente
 Pincas à dissection à griffes
 Pinze per dissezione con denti

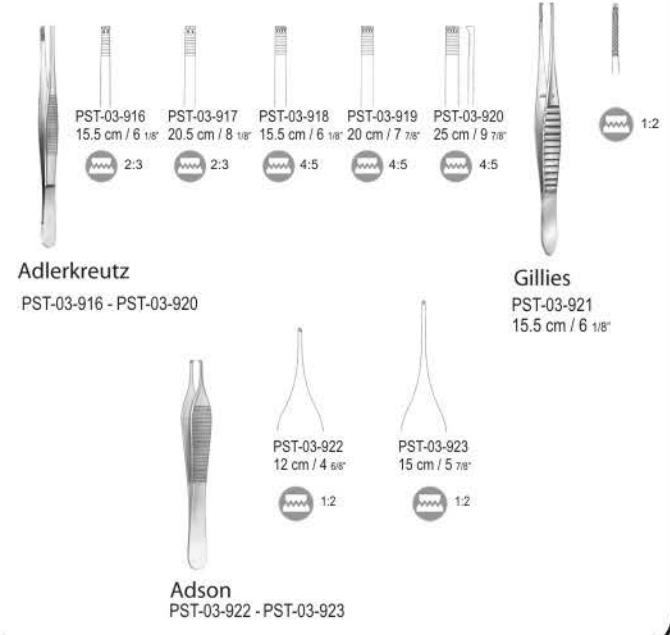

Chirurgische Pinzetten

Tissue Forceps
 Pinzas de disección con diente
 Pincas à dissection à griffes
 Pinze per dissezione con denti

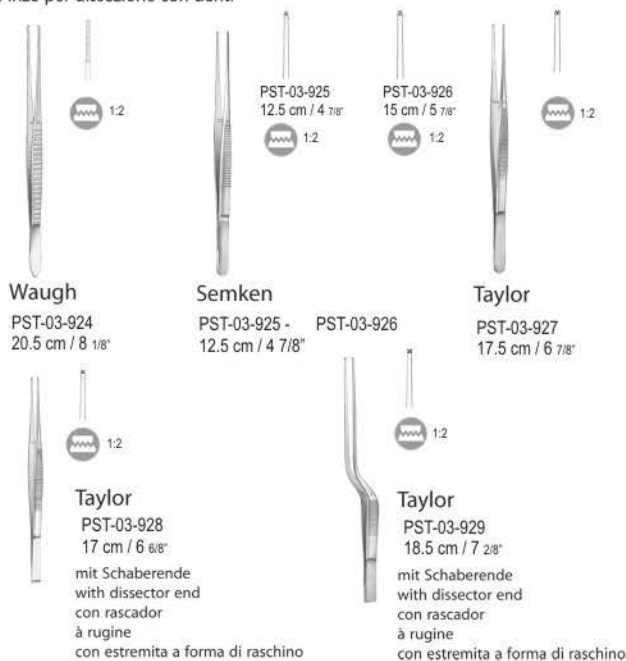

Mikropinzetten, Chirurgische Pinzetten

Micro Tissue Forceps, Tissue Forceps
 Micro Pinzas de disección con dientes, Pinzas de disección con diente
 Micro-Pincas à dissection à griffes, Pincas à dissection à griffes
 Micro-Pinze per dissezione con denti, Pinze per dissezione con denti

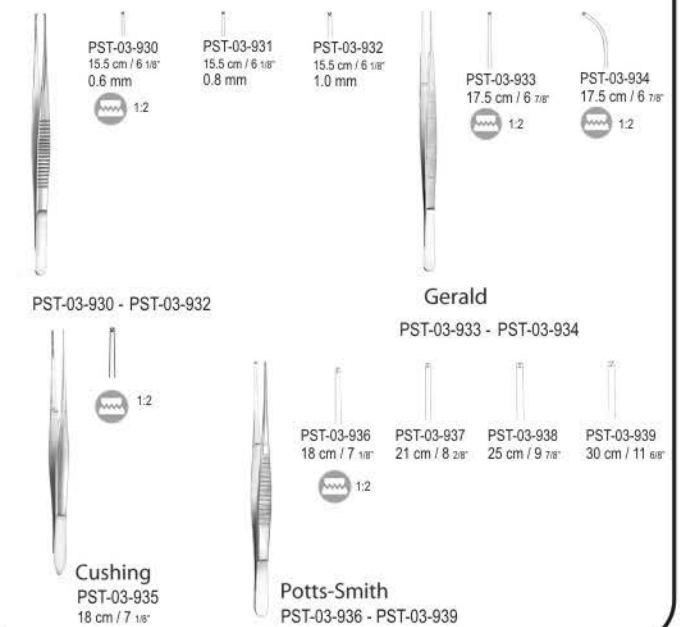

Pinzetten
 Forceps
 Pinzas
 Pincas
 Pinze

03



Quality Instruments

Anatomische Pinzetten, Chirurgische Pinzetten

Dissecting Forceps, Tissue Forceps
 Pinzas de disección, Pinzas de disección con diente
 Pincas à dissection, Pincas à dissection à griffes

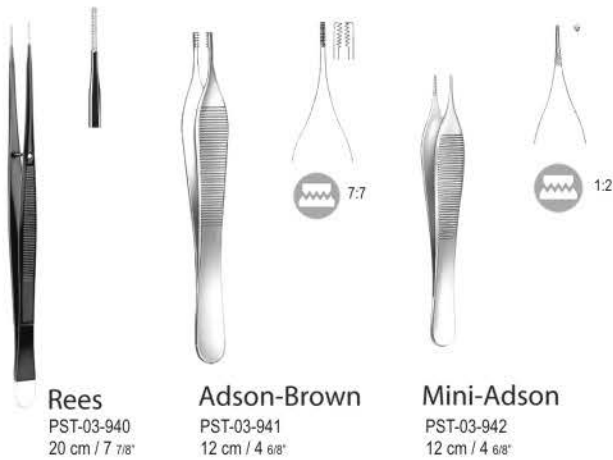

Rees

PST-03-940
 20 cm / 7 7/8"

Adson-Brown

PST-03-941
 12 cm / 4 6/8"

Mini-Adson

PST-03-942
 12 cm / 4 6/8"

isoliert, für Koagulation
 insulated, for coagulation
 aislado, para coagulación
 isolée, pour coagulation
 isolato, per coagulazione

Chirurgische Pinzetten, Anatomische Pinzetten

Tissue Forceps, Dissecting Forceps
 Pinzas de disección con diente, Pinzas de disección
 Pincas à dissection à griffes, Pincas à dissection
 Pinze per dissezione con denti, Pinze per dissezione

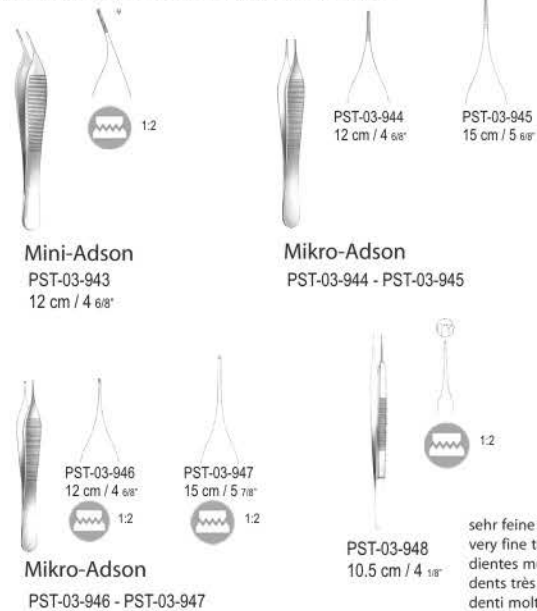

Mini-Adson

PST-03-943
 12 cm / 4 6/8"

Mikro-Adson

PST-03-944 - PST-03-945

Mikro-Adson

PST-03-946 - PST-03-947

PST-03-948
 10.5 cm / 4 1/8"

sehr feine Zähne
 very fine teeth
 dientes muy finos
 dents très fines
 denti molto fini

Uhrmacher-Pinzetten

Jeweler Type Forceps
 Pinzas de relojero
 Pincas d'horloger
 Pinze da orologiaio

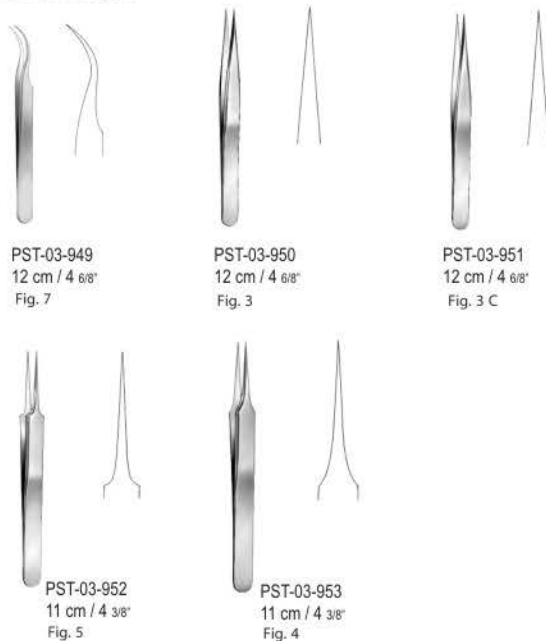

PST-03-949
 12 cm / 4 6/8"
 Fig. 7

PST-03-950
 12 cm / 4 6/8"
 Fig. 3

PST-03-951
 12 cm / 4 6/8"
 Fig. 3 C

PST-03-952
 11 cm / 4 3/8"
 Fig. 5

PST-03-953
 11 cm / 4 3/8"
 Fig. 4

Chirurgische Pinzetten

Tissue Forceps
 Pinzas de disección con diente
 Pincas à dissection à griffes
 Pinze per dissezione con denti

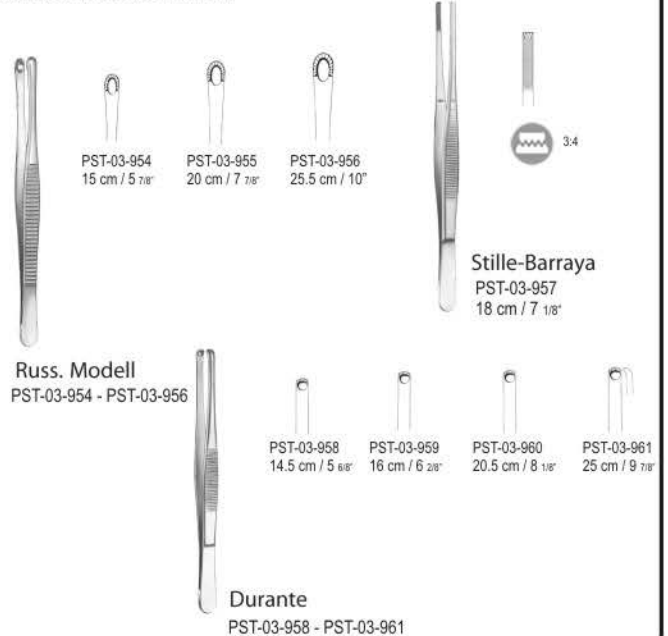

PST-03-954
 15 cm / 5 7/8"

PST-03-955
 20 cm / 7 7/8"

PST-03-956
 25.5 cm / 10"

Russ. Modell
 PST-03-954 - PST-03-956

Stille-Barraya
 PST-03-957
 18 cm / 7 1/8"

Durante
 PST-03-958 - PST-03-961

PST-03-958
 14.5 cm / 5 6/8"

PST-03-959
 16 cm / 6 2/8"

PST-03-960
 20.5 cm / 8 1/8"

PST-03-961
 25 cm / 9 7/8"

Pinzetten
 Forceps
 Pinzas
 Pincas
 Pincas
 Pinze

03



Quality Instruments

Chirurgische Pinzetten

Tissue Forceps
 Pinzas de disección con diente
 Pincas à dissection à griffes
 Pinze per dissezione con denti

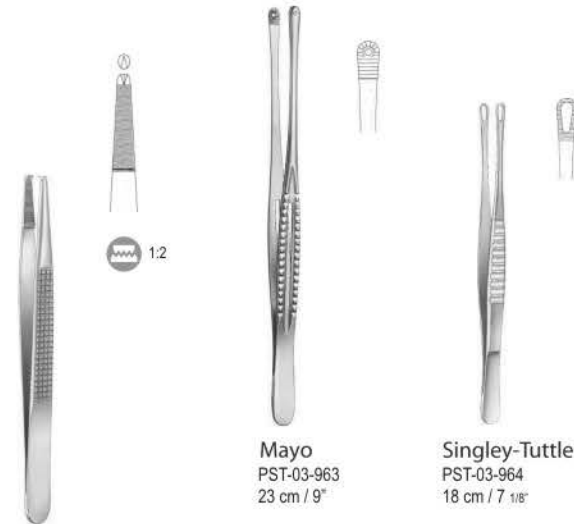

Bonney
 PST-03-962
 17.5 cm / 6 7/8"

Mayo
 PST-03-963
 23 cm / 9"

Singley-Tuttle
 PST-03-964
 18 cm / 7 1/8"

Chirurgische Pinzetten

Tissue Forceps
 Pinzas de disección con diente
 Pincas à dissection à griffes
 Pinze per dissezione con denti



Singley-Tuttle
 PST-03-965
 23 cm / 9"

Nelson
 PST-03-966
 23 cm / 9"



Hepp-Scheidel
 PST-03-967
 18 cm / 7 1/8"

Tubenfasspinzette
 Tubal forceps
 Pinza para tubos
 Pince pour saisir les trompes
 pinza oer afferare tubi

Kunststoffbeschichtetes Maul
 Plastic coated jaw
 Boca de recubrimiento de plástico
 Mors de revêtement en matière plastique
 Morso di rivestimento di plastica



Anatomische Pinzetten, Chirurgische Pinzetten

Dissecting Forceps, Tissue Forceps
 Pinzas de disección, Pinzas de disección con dientes
 Pincas à dissection, Pincas à dissection à griffes
 Pinze per dissezione, Pinze per dissezione con denti



PST-03-968 - PST-03-973

fein
 delicate
 fino
 fin
 fino

Mikropinzetten, Gefäß-Dilatationspinzetten

Micro Forceps, Micro dilating forceps
 Micro Pinzas, Micro pinza de dilatación
 Micro-Pincas, Micro pince à dilater
 Micro-Pinze, Micro pinze per dilatazione

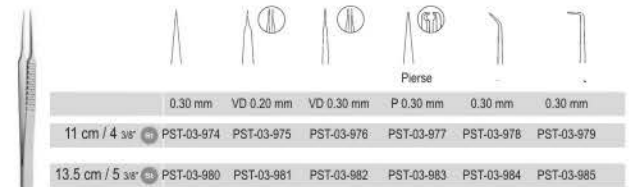

Jeweler mod.
 PST-03-974 - PST-03-985

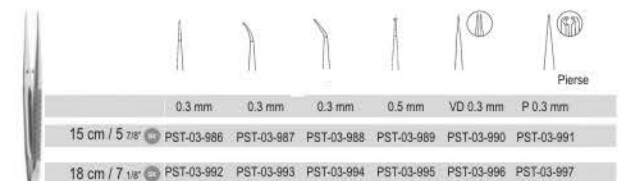

Gefäßdilator
 VD = Vascular Dilator
 Dilatador vascular
 Dilatateur vasculaire
 Dilatatore vascolare



Pinzetten
 Forceps
 Pinzas
 Pincas
 Pinze

03



Quality Instruments

Mikropinzetten, Gefäß-Dilatationspinzetten

Micro Forceps, Micro dilating forceps
 Micro Pinzas, Micro pinza de dilatación
 Micro-Pincas, Micro pince à dilater
 Micro-Pinze, Micro pinze per dilatazione

0.40 mm	0.40 mm	0.40 mm	R Ø 1.0 x 0.5 mm	VD 0.30 mm	P 0.40 mm
15 cm / 5 7/8" PST-03-998	PST-03-998	PST-03-998	PST-03-998	PST-03-998	PST-03-998
18 cm / 7 1/8" PST-03-999	PST-03-999	PST-03-999	PST-03-999	PST-03-999	PST-03-999

Pierse

0.40 mm	0.40 mm	0.70 mm	0.70 mm	0.80 mm	0.80 mm
15 cm / 5 7/8" PST-03-1000	PST-03-1001	PST-03-1002	PST-03-1003	PST-03-1004	PST-03-1004
15 cm / 5 7/8" PST-03-1000	PST-03-1001	PST-03-1002	PST-03-1003	PST-03-1004	PST-03-1004
18 cm / 7 1/8" PST-03-1000	PST-03-1001	PST-03-1002	PST-03-1003	PST-03-1004	PST-03-1004
18 cm / 7 1/8" PST-03-1005	PST-03-1006	PST-03-1007	PST-03-1008		
21 cm / 8 7/8" PST-03-1000	PST-03-1001	PST-03-1002	PST-03-1003	PST-03-1004	PST-03-1004
21 cm / 8 7/8" PST-03-1000	PST-03-1001	PST-03-1002	PST-03-1003	PST-03-1004	PST-03-1004
23 cm / 9" PST-03-1006	PST-03-1007				

VD = Gefäßdilator
 Vascular Dilator
 Dilatador vascular
 Dilatateur vasculaire
 Dilatatore vascolare

Mikropinzetten, Gefäß-Dilatationspinzetten

Micro Forceps
 Micro Pinzas
 Micro-Pincas
 Micro-Pinze

1.2	1.2	1.2	1.2	1.2	1.2
0.40 mm	0.40 mm	0.70 mm	0.70 mm	0.80 mm	0.80 mm
15 cm / 5 7/8" PST-03-1008	PST-03-1009	PST-03-1010	PST-03-1011		
15 cm / 5 7/8" PST-03-1012	PST-03-1013			PST-03-1014	PST-03-1015
18 cm / 7 1/8" PST-03-1016	PST-03-1017	PST-03-1018	PST-03-1019		
18 cm / 7 1/8" PST-03-1020	PST-03-1021			PST-03-1022	PST-03-1023
21 cm / 8 7/8" PST-03-1024	PST-03-1024	PST-03-1025			
21 cm / 8 7/8" PST-03-1026	PST-03-1026	PST-03-1027			
23 cm / 9" PST-03-1028	PST-03-1028	PST-03-1029			

R Ø 1.0 x 0.5 mm	R Ø 2.0 x 1.0 mm	1.2 mm
15 cm / 5 7/8" PST-03-1030	PST-03-1031	PST-03-1032
15 cm / 5 7/8" PST-03-1033	PST-03-1034	PST-03-1035
18 cm / 7 1/8" PST-03-1036	PST-03-1037	PST-03-1038
18 cm / 7 1/8" PST-03-1039	PST-03-1040	PST-03-1041
21 cm / 8 7/8" PST-03-1042	PST-03-1043	PST-03-1044
21 cm / 8 7/8" PST-03-1045	PST-03-1046	PST-03-1047
23 cm / 9" PST-03-1048	PST-03-1049	

VD = Gefäßdilator
 Vascular Dilator
 Dilatador vascular
 Dilatateur vasculaire
 Dilatatore vascolare

Splitterpinzetten

Splinter Forceps
 Pinzas para espinas
 Pincas à échardes
 Pinze per scheggie

PST-03-1050	PST-03-1051	PST-03-1052
glattes Maul smooth jaw boca lisa mors lisse morso liscio	glattes Maul smooth jaw boca lisa mors lisse morso liscio	geriefetes Maul serrated jaw boca estriada mors estries morso striato
		geriefetes Maul serrated jaw boca estriada mors estries morso striato
		PST-03-1053

Mikro-Knüpfpinzette, glattes Maul PST-03-1054
 Micro Tying Forceps, smooth jaw
 Micro Pinza para anudar, boca lisa
 Micro-Pince à poser des ligatures, mors lisse
 Micro-Pinza per legature, morso liscio

Splitterpinzetten

Splinter Forceps
 Pinzas para espinas
 Pincas à échardes
 Pinze per scheggie

PST-03-1055	PST-03-1056	PST-03-1057	PST-03-1058	PST-03-1059
7,5 cm / 3"	9 cm / 3 4/8"	11,5 cm / 4 4/8"	10,5 cm / 4 1/8"	10,5 cm / 4 1/8"
Feilchenfeld PST-03-1055- PST-03-1057			Hunter PST-03-1058 - PST-03-1059	
PST-03-1060 10 cm / 3 7/8"			Shaaf PST-03-1062 9,5 cm / 3 6/8"	

Mikroskopierpinzette, superleicht, stumpf
 Microscopic Forceps, super light, blunt
 Pinza para microscopia, super ligero, roma
 Pince à microscopie, très légère, mousse
 Pinza per microscopia, molto leggera, smussa

Mikroskopierpinzette, superleicht, spitz
 Microscopic Forceps, super light, sharp
 Pinza para microscopia, super ligero, puntiaguda
 Pince à microscopie, très légère, pointue
 Pinza per microscopia, molto leggera, appuntata

Pinzetten
 Forceps
 Pinzas
 Pincas
 Pinze

03



Quality Instruments

Cilienpinzetten

Cilia Forceps
 Pinzas depilatorias
 Pincas à épiler les cils
 Pinze depilatoria



Littauer
 PST-03-1064
 8.5 cm / 3 3/8"
 glattes Maul
 smooth jaw
 boca lisa
 mors lisse
 morso liscio



PST-03-1065
 9 cm / 3 4/8"



Douglas
 PST-03-1066
 9 cm / 3 4/8"



Douglas
 PST-03-1067
 9 cm / 3 4/8"



Beer
 PST-03-1068
 9 cm / 3 4/8"
 glattes Maul
 smooth jaw
 boca lisa
 mors lisse
 morso liscio



Barraquer
 PST-03-1069
 11 cm / 4 3/8"
 glattes Maul
 smooth jaw
 boca lisa
 mors lisse
 morso liscio



Splitterzangen

Splinter Forceps
 Pinzas para espinas
 Pincas à échardes
 Pinze per scheggie



Stieglitz
 PST-03-1070 - PST-03-1071



PST-03-1070
 14 cm / 5 4/8"



PST-03-1071
 13.5 cm / 5 3/8"



Peet
 PST-03-1072
 12.5 cm / 4 7/8"



Ralk
 PST-03-1073 - PST-03-1074



PST-03-1073
 12.5 cm / 4 7/8"



PST-03-1074
 12.5 cm / 4 7/8"



Arterienklemmen **Artery Forceps**
Pinzas Hemostaticas 04
Pinces Hemostatiques
Pinze emostatiche



Quality Instruments

Clip-Anlegepinzette, Gefäßclips

Clip Applying Forceps, Vessel Clips
 Pinzas para aplicar clips,
 Pinces pour poser les clips vasculaires, Clips vasculaires
 Pinze per applicazione clips vascolari,



PST-04-1101
 14.5 cm / 5 8/16"
 ohne Schloss
 without lock
 sin cierre
 sans serrure
 senza serratura



PST-04-1102
 14.5 cm / 5 8/16"
 mit Schloss
 with lock
 con cierre
 avec serrure
 con serratura



Biemer

PST-04-1103 - PST-04-1105 PST-04-1103 PST-04-1104 PST-04-1105

Maulöffnung Jaw opening Abertura de la boca Ouverture de mors Apertura di morso	4 mm	5 mm	5 mm
Maullänge Jaw length Longitud de la boca Longueur de mors Lunghezza del morso	6 mm	9 mm	9 mm
Schließdruck Closing pressure Presión de cierre Pression d'occlusion Pressione di chiusura	30 - 40 gr	30 - 40 gr	20 - 95 gr



Bulldogklemmen

Bulldog Clamps
 Clamps Bulldog
 Clamps Bulldog
 Pinze Bulldog



PST-04-1112
 6 cm / 2 3/8"



PST-04-1113
 6 cm / 2 3/8"



PST-04-1114
 3.5 cm / 1 3/8"



PST-04-1115
 5 cm / 2"



PST-04-1116
 3.5 cm / 1 3/8"



PST-04-1117
 5 cm / 2"



extra leicht
 extra light
 extra ligero
 extrêmement léger
 molto leggera

Dieffenbach

PST-04-1112 - PST-04-1117

PST-04-1106 - PST-04-1111

Länge Length Longitud Longueur Lunghezza	PST-04-1106 31 mm	PST-04-1107 35 mm	PST-04-1108 39 mm	PST-04-1109 30 mm	PST-04-1110 33 mm	PST-04-1111 36 mm
Maullänge Jaw length Longitud de la boca Longueur de mors Lunghezza del morso	10 mm	10 mm	10 mm	10 mm	10 mm	10 mm
Schließdruck Closing pressure Presión de cierre Pression d'occlusion Pressione di chiusura	30 gr	30 gr	30 gr	30 gr	30 gr	30 gr
Gewicht Weight Peso Poids Peso	1 gr	1 gr	1 gr	1 gr	1 gr	1 gr



Bulldogklemmen

Bulldog Clamps
 Clamps Bulldog
 Clamps Bulldog
 Pinze Bulldog



PST-04-1118
 3.8 cm / 1 3/8"



PST-04-1119
 4.5 cm / 1 8/16"



PST-04-1120
 5.5 cm / 2 1/8"



PST-04-1121
 6.5 cm / 2 4/8"



PST-04-1122
 7 cm / 2 4/8"



PST-04-1123
 7.5 cm / 3"



PST-04-1124
 9 cm / 3 4/8"

Dieffenbach

PST-04-1118 - PST-04-1124



PST-04-1125
 3.8 cm / 1 4/8"



PST-04-1126
 4.5 cm / 1 8/16"



PST-04-1127
 5.5 cm / 2 1/8"

Johns-Hopkins

PST-04-1125 - PST-04-1131

PST-04-1128
 6.5 cm / 2 4/8"

PST-04-1129
 7 cm / 2 4/8"

PST-04-1130
 7.5 cm / 3"



Bulldogklemmen

Bulldog Clamps
 Clamps Bulldog
 Clamps Bulldog
 Pinze Bulldog



PST-04-1131
 45 mm



PST-04-1132
 50 mm



PST-04-1133
 60 mm



PST-04-1134
 40 mm



PST-04-1135
 45 mm



PST-04-1136
 50 mm



Diethrich

PST-04-1131
 PST-04-1136

Länge Length Longitud Longueur Lunghezza	PST-04-1131 45 mm	PST-04-1132 50 mm	PST-04-1133 60 mm	PST-04-1134 40 mm	PST-04-1135 45 mm	PST-04-1136 50 mm
Maullänge Jaw length Longitud de la boca Longueur de mors Lunghezza del morso	8 mm	12 mm	20 mm	8 mm	12 mm	20 mm
Schließdruck Closing pressure Presión de cierre Pression d'occlusion Pressione di chiusura	50 gr	50 gr	50 gr	50 gr	50 gr	50 gr
Gewicht Weight Peso Poids Peso	3 gr	3 gr	3 gr	3 gr	3 gr	3 gr



De Bakey

Diethrich
 PST-04-1137
 PST-04-1142

Länge Length Longitud Longueur Lunghezza	PST-04-1137 45 mm	PST-04-1138 50 mm	PST-04-1139 60 mm	PST-04-1140 35 mm	PST-04-1141 45 mm	PST-04-1142 50 mm
Maullänge Jaw length Longitud de la boca Longueur de mors Lunghezza del morso	10 mm	14 mm	20 mm	10 mm	14 mm	20 mm
Schließdruck Closing pressure Presión de cierre Pression d'occlusion Pressione di chiusura	180 gr	180 gr	180 gr	180 gr	180 gr	180 gr
Gewicht Weight Peso Poids Peso	3gr	3gr	3gr	3gr	3gr	3gr



Arterienklemmen
 Artery Forceps
 Pinzas Hemostaticas
 Pinces Hemostatiques
 Pinze emostatiche 04



Quality Instruments

Bulldogklemmen

Bulldog Clamps
 Clamps Bulldog
 Clamps Bulldog
 Pinze Bulldog



PST-04-1143	PST-04-1143 vena	PST-04-1144 vena	PST-04-1145 vena	PST-04-1146 vena
Schließdruck Closing pressure Presión de cierre Pression d'occlusion Pressione di chiusura	110 +/- 10 gr	110 +/- 10 gr	110 +/- 10 gr	110 +/- 10 gr
	PST-04-1147 Arteria	PST-04-1148 Arteria	PST-04-1149 Arteria	PST-04-1150 Arteria
Schließdruck Closing pressure Presión de cierre Pression d'occlusion Pressione di chiusura	220 +/- 10 gr	220 +/- 10 gr	220 +/- 10 gr	220 +/- 10 gr
Länge Length Longitud Longueur Lunghezza	30 mm	35 mm	40 mm	50 mm
Maullänge Jaw length Longitud de la boca Longueur de mors Lunghezza del morso	9 mm	13 mm	14 mm	23 mm
Gewicht Weight Peso Poids Peso	1 gr	1 gr	1 gr	1.5 gr



Bulldogklemmen

Bulldog Clamps
 Clamps Bulldog
 Clamps Bulldog
 Pinze Bulldog



PST-04-1151 - PST-04-1158

	PST-04-1151 vena	PST-04-1152 vena	PST-04-1153 vena	PST-04-1154 vena
Schließdruck Closing pressure Presión de cierre Pression d'occlusion Pressione di chiusura	110 +/- 10 gr	110 +/- 10 gr	110 +/- 10 gr	110 +/- 10 gr
	PST-04-1155 Arteria	PST-04-1156 Arteria	PST-04-1157 Arteria	PST-04-1158 Arteria
Schließdruck Closing pressure Presión de cierre Pression d'occlusion Pressione di chiusura	220 +/- 10 gr	220 +/- 10 gr	220 +/- 10 gr	220 +/- 10 gr
Länge Length Longitud Longueur Lunghezza	30 mm	35 mm	40 mm	50 mm
Maullänge Jaw length Longitud de la boca Longueur de mors Lunghezza del morso	9 mm	13 mm	14 mm	23 mm
Gewicht Weight Peso Poids Peso	1 gr	1 gr	1 gr	1.5 gr



Bulldogklemmen

Bulldog Clamps
 Clamps Bulldog
 Clamps Bulldog
 Pinze Bulldog



PST-04-1159 PST-04-1166	PST-04-1159 vena	PST-04-1160 vena	PST-04-1161 vena	PST-04-1162 vena
Schließdruck Closing pressure Presión de cierre Pression d'occlusion Pressione di chiusura	110 +/- 10 gr	110 +/- 10 gr	110 +/- 10 gr	110 +/- 10 gr
	PST-04-1163 Arteria	PST-04-1164 Arteria	PST-04-1165 Arteria	PST-04-1166 Arteria
Schließdruck Closing pressure Presión de cierre Pression d'occlusion Pressione di chiusura	220 +/- 10 gr	220 +/- 10 gr	220 +/- 10 gr	220 +/- 10 gr
Länge Length Longitud Longueur Lunghezza	30 mm	35mm	40mm	50mm
Maullänge Jaw length Longitud de la boca Longueur de mors Lunghezza del morso	9 mm	13mm	14mm	23mm
Gewicht Weight Peso Poids Peso	1 gr	1 gr	1 gr	1.5 gr



Arterienklemmen

Haemostatic Forceps
 Pinzas hemostáticas
 Pinces hémostatiques
 Pinze emostatiche

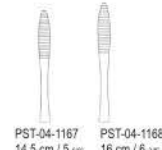

Pean
 PST-04-1167 - PST-04-1168

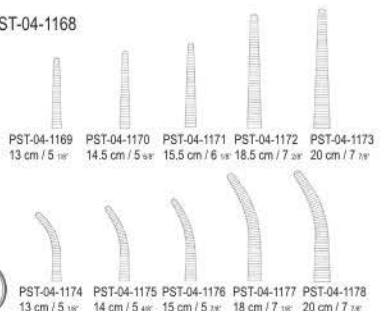

Spencer-Wells
 PST-04-1169 - PST-04-1178



Arterienklemmen **Artery Forceps**
Pinzas Hemostaticas **04**
Pinces Hemostatiques
Pinze emostatiche



Quality Instruments

Arterienklemmen, Organfasszangen

Haemostatic Forceps, Organ Grasping Forceps
 Pinzas hemostáticas, Pinzas para sacar órganos
 Pinces hémostatiques, Pinces pour saisir organes
 Pinze emostatiche, Pinze per afferrare organi



Chaput
 PST-04-1179
 12.5 cm / 4 7/8"

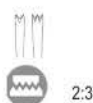

2:3



Tuffier
 PST-04-1180
 12.5 cm / 4 7/8"



4:5



PST-04-1181
 25 cm / 9 7/8"



PST-04-1182
 25 cm / 10 7/8"

PST-04-1181 - PST-04-1182

Organfasszangen

Organ Grasping Forceps
 Pinzas para sacar órganos
 Pinces pour saisir organes
 Pinze per afferrare organi



Collin
 PST-04-1183
 14 cm / 5 4/8"



Collin
 PST-04-1184
 17 cm / 6 6/8"
 Tumorfasszange
 Tumor Grasping Forceps
 Pinzas para sacar órganos
 Pinces à tumeurs à vis
 Pinze per afferrare tumori



Pennington
 PST-04-1185 - PST-04-1186

PST-04-1185
 15.5 cm / 6 1/8"



PST-04-1186
 21 cm / 8 2/8"

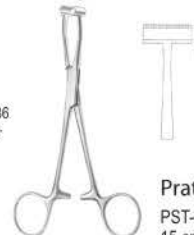

Pratt
 PST-04-1187
 15 cm / 5 7/8"



Arterienklemmen, Präparierklemmen

Haemostatic Forceps, Dissecting and Ligature Forceps
 Pinzas hemostáticas, Pinzas para preparación y ligadura
 Pinces hémostatiques, Pinces à dissequer et à ligatures
 Pinze emostatiche, Pinze per preparazioni e legature



Martel-Rees
 PST-04-1188
 13.5 cm / 5 3/8"
 Face-lift-Klemme
 Face-lift Forceps
 Pinza para Face-lift
 Pinces pour Face-lift
 Pinze per Face-lift



PST-04-1189
 12.5 cm / 4 7/8"
 Fadenklemme, glattes Maul
 Ligature Forceps, smooth jaw
 Pinza para hilos, boca lisa
 Pince à ligatures, mors lisse
 Pinza per legature, morso liscio



Mixer-Baby
 PST-04-1190 - PST-04-1191

PST-04-1190
 13.5 cm / 5 3/8"

PST-04-1191
 13 cm / 5 1/8"



PST-04-1192 PST-04-1193

Hartmann
 PST-04-1192 - PST-04-1193
 10 cm / 3 7/8"



PST-04-1194
 12 cm / 4 6/8"
 Fadenklemme
 Ligature Forceps
 Pinza para hilos
 Pince à ligatures
 Pinza per legature

kreuzgerieftes Maul
 cross serrated jaw
 boca estriada en forma de cruz
 mors à rainures croisées
 morso con striatura cruciforme



Arterienklemmen

Haemostatic Forceps
 Pinzas hemostáticas
 Pinces hémostatiques
 Pinze emostatiche



Halsted-Mosquito
 PST-04-1195 - PST-04-1202

PST-04-1195 12.5 cm / 4 7/8" PST-04-1196 14.5 cm / 5 6/8" PST-04-1197 12 cm / 4 6/8" PST-04-1198 14 cm / 5 4/8"

PST-04-1199 12.5 cm / 4 7/8" PST-04-1200 14.5 cm / 5 6/8" PST-04-1201 12.5 cm / 4 7/8" PST-04-1202 14.5 cm / 5 6/8"



Halsted-Mosquito
 PST-04-1203 - PST-04-1206

PST-04-1203 12.5 cm / 4 7/8" PST-04-1204 12 cm / 4 6/8" PST-04-1205 12 cm / 4 6/8" PST-04-1206 12 cm / 4 6/8"

Arterienklemmen **Artery Forceps** **Pinzas Hemostáticas** **04**
Pinces Hémostatiques
Pinze emostatiche



Quality Instruments

Arterienklemmen
 Haemostatic Forceps
 Pinzas hemostáticas
 Pinces hémostatiques
 Pinze emostatiche

PST-04-1207 18.5 cm / 7 2/8"
 PST-04-1208 21 cm / 8 2/8"
 PST-04-1209 18 cm / 7 1/8"
 PST-04-1210 20.5 cm / 8 1/8"

Halsted-Mosquito
 PST-04-1207 - PST-04-1214

PST-04-1211 18.5 cm / 7 2/8"
 PST-04-1212 21 cm / 8 2/8"
 PST-04-1213 18 cm / 7 1/8"
 PST-04-1214 20.5 cm / 8 1/8"

Arterienklemmen
 Haemostatic Forceps
 Pinzas hemostáticas
 Pinces hémostatiques
 Pinze emostatiche

PST-04-1215 10 cm / 3 7/8"
 PST-04-1216 12 cm / 4 8/8"
 PST-04-1217 10 cm / 3 7/8"
 PST-04-1218 12 cm / 4 8/8"

Mikro-Mosquito
 PST-04-1215 - PST-04-1222

PST-04-1219 10 cm / 3 7/8"
 PST-04-1220 12 cm / 4 8/8"
 PST-04-1221 10 cm / 3 7/8"
 PST-04-1222 12 cm / 4 8/8"

Providence-Hospital
 PST-04-1223 - PST-04-1224

PST-04-1223 14 cm / 5 4/8"
 PST-04-1224 13.5 cm / 5 3/8"

Leriche
 PST-04-1225 - PST-04-1228

PST-04-1225 15.5 cm / 6 1/8"
 PST-04-1226 15 cm / 5 7/8"
 PST-04-1227 15.5 cm / 6 1/8"
 PST-04-1228 15 cm / 5 7/8"

Arterienklemmen
 Haemostatic Forceps
 Pinzas hemostáticas
 Pinces hémostatiques
 Pinze emostatiche

Kelly
 PST-04-1229 - PST-04-1232

PST-04-1229 14.5 cm / 5 8/8"
 PST-04-1230 14.5 cm / 5 8/8"
 PST-04-1231 14 cm / 5 4/8"
 PST-04-1232 14 cm / 5 4/8"

Dunhill
 PST-04-1233 12.5 cm / 4 7/8"

Dunhill
 PST-04-1234 18.5 cm / 7 2/8"

Kelly-Rankin
 PST-04-1235 - PST-04-1236 16 cm / 6 2/8"

PST-04-1235 PST-04-1236

Arterienklemmen, Präparierklemmen
 Haemostatic Forceps, Dissecting and Ligature Forceps
 Pinzas hemostáticas, Pinzas para preparación y ligadura
 Pinces hémostatiques, Pinces à dissequer et à ligatures
 Pinze emostatiche, Pinze per preparazioni e legature

Obwegeser
 PST-04-1237 19 cm / 7 4/8"
 Drahtfangklemme
 Wire Catching Forceps
 Pinza para coger alambre
 Pince pour attrape le fil métallique
 Pinza di cattura di filo di ferro

Overholt-Baby
 PST-04-1238 13.5 cm / 5 3/8"

Crile
 PST-04-1239 - PST-04-1244 14.5 cm / 5 8/8"

PST-04-1239 PST-04-1240 PST-04-1241 PST-04-1242 PST-04-1243 PST-04-1244



Arterienklemmen
Artery Forceps
Pinzas Hemostaticas
Pinces Hemostatiques
Pinze emostatiche **04**



Quality Instruments

Arterienklemmen
 Haemostatic Forceps
 Pinzas hemostáticas
 Pinces hémostatiques
 Pinze emostatiche

PST-04-1245 PST-04-1246 PST-04-1247 PST-04-1248
 1.2

Crile-Rankin
 PST-04-1245 - PST-04-1246
 16 cm / 6 2/8"

PST-04-1247 PST-04-1248

Lovlace
 PST-04-1247 - PST-04-1248
 16 cm / 6 2/8"

PST-04-1249 PST-04-1250

Dandy-Mosquito
 PST-04-1249
 12 cm / 4 6/8"
 seitlich gebogen
 laterally curved
 curva lateralmente
 courbe lateralement
 curva laterale

PST-04-1250 PST-04-1251
 1.2

Dandy
 PST-04-1250 - PST-04-1251
 14.5 cm / 5 6/8"
 seitlich gebogen
 laterally curved
 curva lateralmente
 courbe lateralement
 curva laterale



Arterienklemmen, Präparierklemmen
 Haemostatic Forceps, Dissecting and Ligature Forceps
 Pinzas hemostáticas, Pinzas para preparación y ligadura
 Pinces hémostatiques, Pinces à dissequer et à ligatures
 Pinze emostatiche, Pinze per preparazioni e legature

PST-04-1252 PST-04-1253
 18.5 cm / 7 2/8" 19 cm / 7 4/8"

Schnidt
 PST-04-1252 - PST-04-1253

PST-04-1254 PST-04-1255
 19 cm / 7 4/8" 18.5 cm / 7 2/8"

Adson
 PST-04-1254 - PST-04-1255

PST-04-1256 PST-04-1257 PST-04-1258 PST-04-1259 PST-04-1260
 20.5 cm / 8 1/8" 17 cm / 6 6/8" 20.5 cm / 8 1/8" 16.5 cm / 6 4/8" 20 cm / 7 7/8"

Martin-Fuchsig
 PST-04-1256
 20.5 cm / 8 1/8"

PST-04-1257 PST-04-1258 PST-04-1259 PST-04-1260

Rochester-Carmalt
 PST-04-1257 - PST-04-1260



Arterienklemmen
 Haemostatic Forceps
 Pinzas hemostáticas
 Pinces hémostatiques
 Pinze emostatiche

PST-04-1261 PST-04-1262 PST-04-1263 PST-04-1264 PST-04-1265 PST-04-1266
 13.5 cm / 5 3/8" 14.5 cm / 5 6/8" 17 cm / 6 4/8" 13 cm / 5 1/8" 14 cm / 5 4/8" 16.5 cm / 6 4/8"

Pean
 PST-04-1261 - PST-04-1266

PST-04-1267 PST-04-1268 PST-04-1269 PST-04-1270 PST-04-1271 PST-04-1272
 14.5 cm / 5 6/8" 16.5 cm / 6 4/8" 18.5 cm / 7 2/8" 14 cm / 5 4/8" 16 cm / 6 2/8" 18 cm / 7 1/8"

Pean-Nippon
 PST-04-1267 - PST-04-1272



Arterienklemmen
 Haemostatic Forceps
 Pinzas hemostáticas
 Pinces hémostatiques
 Pinze emostatiche

PST-04-1273 PST-04-1274 PST-04-1275 PST-04-1276 PST-04-1277 PST-04-1278
 14.5 cm / 5 6/8" 16.5 cm / 6 4/8" 18.5 cm / 7 2/8" 14 cm / 5 4/8" 16 cm / 6 2/8" 18 cm / 7 1/8"

Kocher-Nippon
 PST-04-1273 - PST-04-1278

PST-04-1279 PST-04-1280 PST-04-1281 PST-04-1282 PST-04-1283 PST-04-1284
 13 cm / 5 1/8" 14 cm / 5 4/8" 16 cm / 6 2/8" 13 cm / 5 1/8" 14 cm / 5 4/8" 16 cm / 6 2/8"

Kocher
 PST-04-1279 - PST-04-1284



Arterienklemmen **04**
 Artery Forceps
 Pinzas Hemostaticas
 Pinces Hemostatiques
 Pinze emostatiche



Quality Instruments

Arterienklemmen
 Haemostatic Forceps
 Pinzas hemostáticas
 Pinces hémostatiques
 Pinze emostatiche

PST-04-1285 21.5 cm / 8 4/8"	PST-04-1286 26 cm / 10 2/8"	PST-04-1287 21.5 cm / 8 4/8"	PST-04-1288 26 cm / 10 2/8"
PST-04-1289 21.5 cm / 8 4/8" 1:2	PST-04-1290 26 cm / 10 2/8" 1:2	PST-04-1291 21.5 cm / 8 4/8" 1:2	PST-04-1292 26 cm / 10 2/8" 1:2

Bengolea
 PST-04-1285 - PST-04-1292

Arterienklemmen
 Haemostatic Forceps
 Pinzas hemostáticas
 Pinces hémostatiques
 Pinze emostatiche

PST-04-1293 14.5 cm / 5 6/8"	PST-04-1294 16.5 cm / 6 4/8"	PST-04-1295 18.5 cm / 7 2/8"	PST-04-1296 20.5 cm / 8 1/8"
PST-04-1297 22.5 cm / 8 7/8"	PST-04-1298 24.5 cm / 9 6/8"	PST-04-1299 26 cm / 10 2/8"	PST-04-1300 30.5 cm / 12"

Pean (Rochester)
 PST-04-1293 - PST-04-1300

Arterienklemmen
 Haemostatic Forceps
 Pinzas hemostáticas
 Pinces hémostatiques
 Pinze emostatiche

PST-04-1301 14.5 cm / 5 6/8"	PST-04-1302 16.5 cm / 6 4/8"	PST-04-1303 18.5 cm / 7 2/8"	PST-04-1304 20.5 cm / 8 1/8"
PST-04-1305 22.5 cm / 8 2/8"	PST-04-1306 24.5 cm / 9 6/8"	PST-04-1307 26 cm / 10 2/8"	PST-04-1308 30.5 cm / 12"

Pean (Rochester)
 PST-04-1301 - PST-04-1308

Arterienklemmen
 Haemostatic Forceps
 Pinzas hemostáticas
 Pinces hémostatiques
 Pinze emostatiche

PST-04-1309 14.5 cm / 5 6/8" 1:2	PST-04-1310 16.5 cm / 6 4/8" 1:2	PST-04-1311 18.5 cm / 7 2/8" 1:2	PST-04-1312 20.5 cm / 8 1/8" 1:2
PST-04-1313 22.5 cm / 8 2/8" 1:2	PST-04-1314 24 cm / 9 4/8" 1:2	PST-04-1315 26 cm / 10 2/8" 1:2	PST-04-1316 31 cm / 12 2/8" 1:2

Kocher (Ochsner)
 PST-04-1309 - PST-04-1316

Arterienklemmen
Artery Forceps
Pinzas Hemostaticas
Pinces Hemostatiques
Pinze emostatiche **04**



Quality Instruments

Arterienklemmen
 Haemostatic Forceps
 Pinzas hemostáticas
 Pinces hémostatiques
 Pinze emostatiche

PST-04-1317 14,5 cm / 5 5/8"
 PST-04-1318 16,5 cm / 6 4/8"
 PST-04-1319 18,5 cm / 7 2/8"
 PST-04-1320 20,5 cm / 8 1/8"
 PST-04-1321 22,5 cm / 8 7/8"
 PST-04-1322 24 cm / 9 4/8"
 PST-04-1323 26 cm / 10 2/8"
 PST-04-1324 31 cm / 12 2/8"

Kocher (Ochsner)
 PST-04-1317 - PST-04-1324

Präparierklemmen
 Dissecting and Ligature Forceps
 Pinzas para preparación y ligadura
 Pincas à disséquer et à ligatures
 Pinze per preparazioni e legature

Fig.1 PST-04-1325 18,5 cm / 7 2/8"
 Fig.2 PST-04-1326 20,5 cm / 8 1/8"
 Fig.3 PST-04-1327 21 cm / 8 2/8"
 Fig.4 PST-04-1328 21,5 cm / 8 2/8"
 Fig.5 PST-04-1329 24,5 cm / 9 5/8"

Overholt-Martin
 PST-04-1325 - PST-04-1329

Präparierklemmen
 Dissecting and Ligature Forceps
 Pinzas para preparación y ligadura
 Pincas à disséquer et à ligatures
 Pinze per preparazioni e legature

PST-04-1331 14,5 cm / 5 5/8"
 PST-04-1332 18 cm / 7 1/8"
 PST-04-1333 21 cm / 8 2/8"
 PST-04-1334 20,5 cm / 8 1/8"
 PST-04-1335 20 cm / 7 7/8"
 PST-04-1336 22 cm / 8 5/8"

Mixer-Baby
 PST-04-1330
 18,5 cm / 7 2/8"

Adson-Baby
 PST-04-1331 - PST-04-1332

Heiss
 PST-04-1333 - PST-04-1335

Overholt-Mixer
 PST-04-1336
 22 cm / 8 5/8"

Präparierklemmen
 Dissecting and Ligature Forceps
 Pinzas para preparación y ligadura
 Pincas à disséquer et à ligatures
 Pinze per preparazioni e legature

PST-04-1337 22,5 cm / 8 7/8"
 PST-04-1338 22 cm / 8 5/8"
 PST-04-1339 25 cm / 9 7/8"
 PST-04-1340 24,5 cm / 9 5/8"

Roberts
 PST-04-1337 - PST-04-1338

Sarot
 PST-04-1339 - PST-04-1340

Arterienklemmen **Artery Forceps**
Pinzas Hemostaticas **04**
Pinces Hemostatiques
Pinze emostatiche



Quality Instruments

Präparierklemmen
 Dissecting and Ligature Forceps
 Pinzas para preparación y ligadura
 Pincas à disséquer et à ligatures
 Pinze per preparazioni e legature

Crafoord
 PST-04-1341 - PST-04-1342
 18.5 cm / 7 3/8" 24.5 cm / 9 5/8"

Crafoord-Sellors
 PST-04-1343 - PST-04-1345
 24 cm / 9 4/8"
 Gefäßklemme
 Vascular clamp
 Pinza para vasos
 Pince vasculaires
 Pinza vascolari

Präparierklemmen
 Dissecting and Ligature Forceps
 Pinzas para preparación y ligadura
 Pincas à disséquer et à ligatures
 Pinze per preparazioni e legature

Overholt-Geissendörfer
 PST-04-1346 - PST-04-1359

Fig. 1	Fig. 2	Fig. 3	Fig. 4	Fig. 5	Fig. 6	Fig. 7
PST-04-1346	PST-04-1347	PST-04-1348	PST-04-1349	PST-04-1350	PST-04-1351	PST-04-1352
20.5 cm / 8 1/8"	20 cm / 7 7/8"	21.5 cm / 8 4/8"	22 cm / 8 1/8"	21.5 cm / 8 4/8"	22 cm / 8 1/8"	22 cm / 8 1/8"

Fig. 1	Fig. 2	Fig. 3	Fig. 4
PST-04-1353	PST-04-1354	PST-04-1355	PST-04-1356
27 cm / 10 5/8"	26.5 cm / 10 3/8"	27.5 cm / 10 7/8"	28 cm / 11"

Fig. 5	Fig. 6	Fig. 7
PST-04-1357	PST-04-1358	PST-04-1359
27.5 cm / 10 7/8"	28 cm / 11"	27.5 cm / 10 7/8"

Präparierklemmen
 Dissecting and Ligature Forceps
 Pinzas para preparación y ligadura
 Pincas à disséquer et à ligatures
 Pinze per preparazioni e legature

Overholt-Fino
 PST-04-1360 - PST-04-1364

PST-04-1360	PST-04-1361	PST-04-1362	PST-04-1363	PST-04-1364
21.5 cm / 8 4/8"	22 cm / 8 5/8"	22.5 cm / 8 7/8"	23 cm / 9"	22.5 cm / 8 7/8"

Präparierklemmen
 Dissecting and Ligature Forceps
 Pinzas para preparación y ligadura
 Pincas à disséquer et à ligatures
 Pinze per preparazioni e legature

Overholt
 PST-04-1365 - PST-04-1367

PST-04-1365	PST-04-1366	PST-04-1367
29.5 cm / 11 5/8"	29.5 cm / 11 5/8"	30 cm / 11 5/8"

Overholt-Mini
 PST-04-1368
 15 cm / 5 7/8"

Overholt-Mini
 PST-04-1369
 20 cm / 7 7/8"

Arterienklemmen **Artery Forceps**
Pinzas Hemostaticas **04**
Pinces Hemostatiques
Pinze emostatiche



Quality Instruments

Präparierklemmen

Dissecting and Ligature Forceps
 Pinzas para preparación y ligadura
 Pincas à disséquer et à ligatures
 Pinze per preparazioni e legature

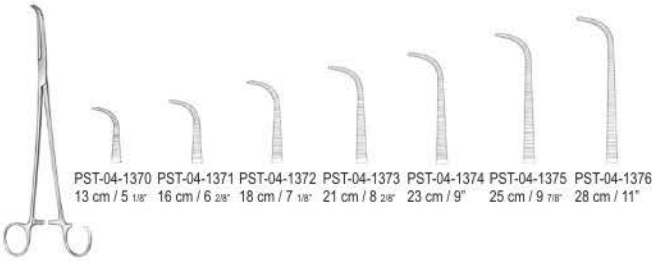

PST-04-1370 13 cm / 5 1/8" PST-04-1371 16 cm / 6 2/8" PST-04-1372 18 cm / 7 1/8" PST-04-1373 21 cm / 8 2/8" PST-04-1374 23 cm / 9" PST-04-1375 25 cm / 9 7/8" PST-04-1376 28 cm / 11"

Gemini
 PST-04-1370 - PST-04-1376

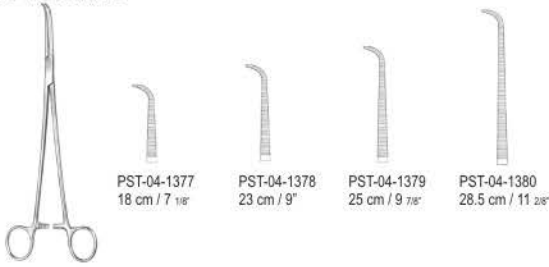

PST-04-1377 18 cm / 7 1/8" PST-04-1378 23 cm / 9" PST-04-1379 25 cm / 9 7/8" PST-04-1380 28.5 cm / 11 2/8"

Mini-Gemini
 PST-04-1377 - PST-04-1380



Präparierklemmen

Dissecting and Ligature Forceps
 Pinzas para preparación y ligadura
 Pincas à disséquer et à ligatures
 Pinze per preparazioni e legature

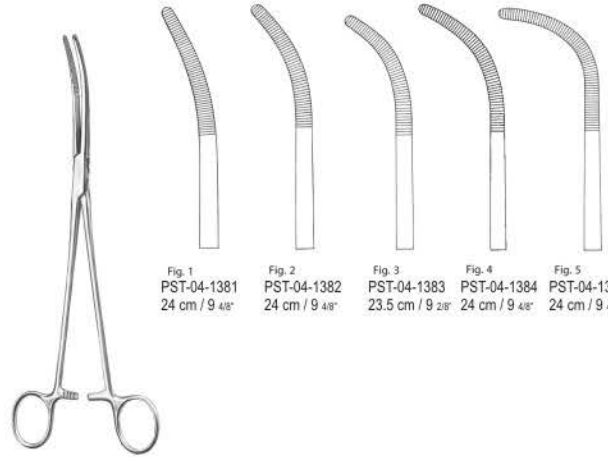

Fig. 1 PST-04-1381 24 cm / 9 4/8" Fig. 2 PST-04-1382 24 cm / 9 4/8" Fig. 3 PST-04-1383 23.5 cm / 9 2/8" Fig. 4 PST-04-1384 24 cm / 9 4/8" Fig. 5 PST-04-1385 24 cm / 9 4/8"

Rumel
 PST-04-1381 - PST-04-1385



Präparierklemmen

Dissecting and Ligature Forceps
 Pinzas para preparación y ligadura
 Pincas à disséquer et à ligatures
 Pinze per preparazioni e legature

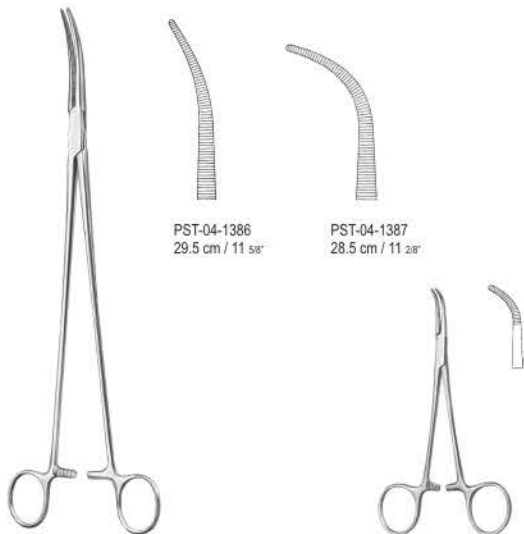

PST-04-1386 29.5 cm / 11 5/8" PST-04-1387 28.5 cm / 11 2/8"

Zenker
 PST-04-1386 - PST-04-1387

Mixer-Baby
 PST-04-1388
 13 cm / 5 1/8"



Präparierklemmen

Dissecting and Ligature Forceps
 Pinzas para preparación y ligadura
 Pincas à disséquer et à ligatures
 Pinze per preparazioni e legature

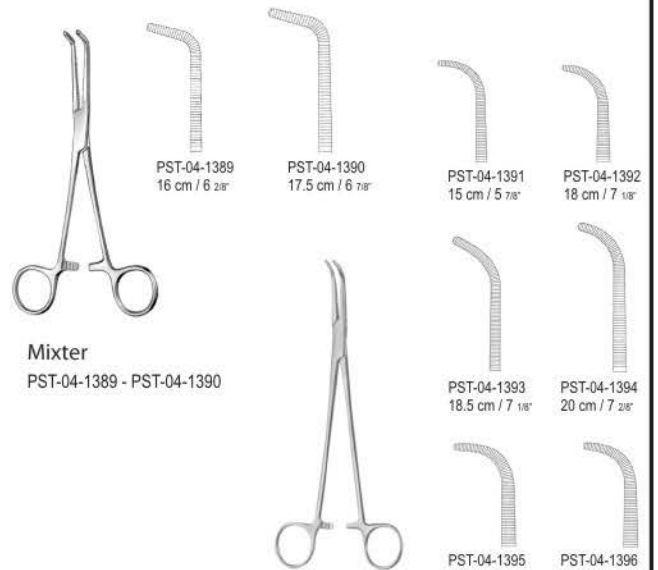

PST-04-1389 16 cm / 6 2/8" PST-04-1390 17.5 cm / 6 7/8" PST-04-1391 15 cm / 5 7/8" PST-04-1392 18 cm / 7 1/8"

Mixer
 PST-04-1389 - PST-04-1390

O'Shaughnessy
 PST-04-1391 - PST-04-1396

PST-04-1393 18.5 cm / 7 1/8" PST-04-1394 20 cm / 7 2/8"

PST-04-1395 23 cm / 9" PST-04-1396 26 cm / 10 2/8"



Arterienklemmen **Artery Forceps**
 Pinzas Hemostaticas **04**
 Pinces Hemostatiques
 Pinze emostatiche



Quality Instruments

Präparierklemmen

Dissecting and Ligature Forceps
 Pinzas para preparación y ligadura
 Pinces à disséquer et à ligatures
 Pinze per preparazioni e legature



Mixer
 PST-04-1397
 22.5 cm / 8 7/8"

Mixer
 PST-04-1398
 23 cm / 9"



Präparierklemmen

Dissecting and Ligature Forceps
 Pinzas para preparación y ligadura
 Pinces à disséquer et à ligatures
 Pinze per preparazioni e legature

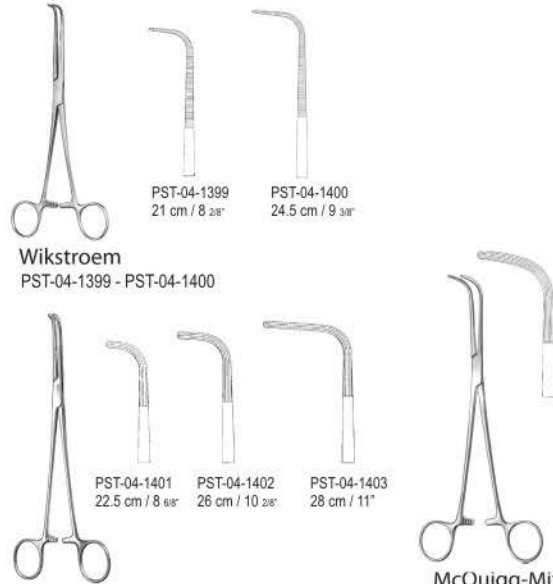

PST-04-1399
 21 cm / 8 2/8"

PST-04-1400
 24.5 cm / 9 3/8"

Wikstroem
 PST-04-1399 - PST-04-1400

PST-04-1401
 22.5 cm / 8 5/8"

PST-04-1402
 26 cm / 10 2/8"

PST-04-1403
 28 cm / 11"

Mixer
 PST-04-1401 - PST-04-1403

McQuigg-Mixer
 PST-04-1404
 23.5 cm / 9 2/8"



Gallenkanalklemmen, Präparierklemmen

Bile Duct Clamps, Dissecting and Ligature Forceps
 Pinzas para conducto biliar, Pinzas para preparación y ligadura
 Pinces pour les voies biliaires, Pinces à disséquer et à ligatures
 Pinze per vie biliari, Pinze per preparazioni e legature

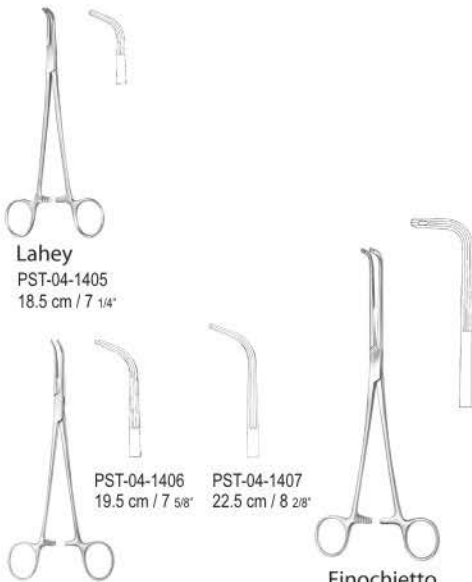

Lahey
 PST-04-1405
 18.5 cm / 7 1/4"

PST-04-1406
 19.5 cm / 7 5/8"

PST-04-1407
 22.5 cm / 8 2/8"

Lahey
 PST-04-1406 - PST-04-1407

Finochietto
 PST-04-1408
 24.5 cm / 9 5/8"



Tangentialklemmen, Nierenstieltklemmen

Tangential Forceps, Kidney Pedicle Clamps
 Pinzas tangenciales, Pinzas para pediculo renal
 Pinces tangentielles, Pince-clamps pour pédicules rénaux
 Pinze tangenziali, Pinze per peduncoli renali

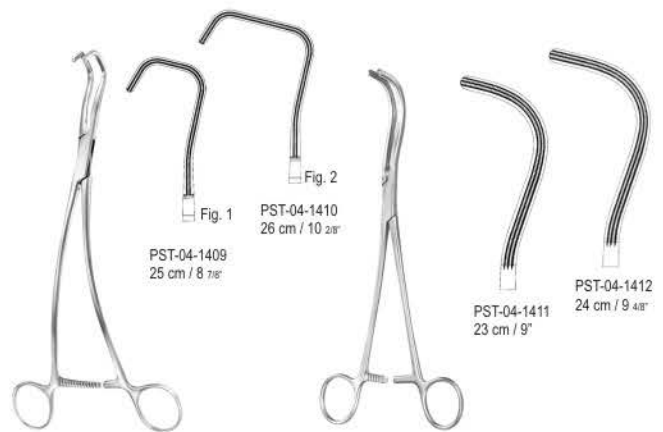

PST-04-1409
 25 cm / 8 7/8"

Fig. 1
 PST-04-1410
 26 cm / 10 2/8"

Fig. 2

PST-04-1411
 23 cm / 9"

PST-04-1412
 24 cm / 9 4/8"

Uro-Tangential
 PST-04-1409 - PST-04-1410

Guyon
 PST-04-1411 - PST-04-1412



Arterienklemmen
Artery Forceps
Pinzas Hemostaticas
Pinces Hemostatiques
Pinze emostatiche **04**



Quality Instruments

Nierenstielklemmen

Kidney Pedicle Clamps
 Pinzas para pedículo renal
 Pince-clamps pour pédicules rénaux
 Pinze per peduncoli renali

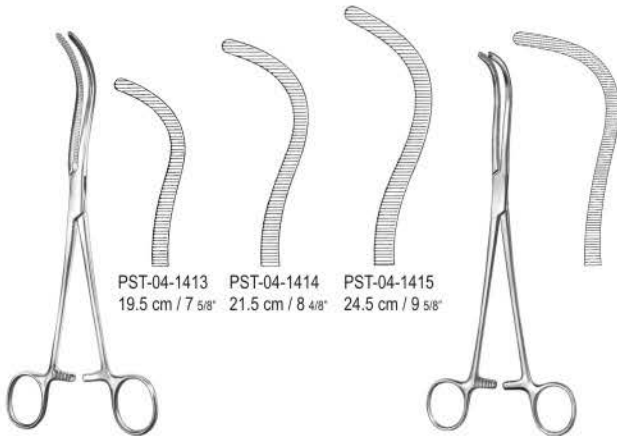

PST-04-1413 19.5 cm / 7 5/8"
 PST-04-1414 21.5 cm / 8 4/8"
 PST-04-1415 24.5 cm / 9 5/8"

Guyon
 PST-04-1413 - PST-04-1415

Guyon
 PST-04-1416
 24 cm / 9 4/8"

Gallenkanalklemmen

Bile Duct Clamps
 Pinzas para conducto biliar
 Pinces pour les voies biliaires
 Pinze per vie biliari



Desjardins
 PST-04-1417
 21 cm / 8 2/8"

Präparierklemmen

Dissecting and Ligature Forceps
 Pinzas para preparación y ligadura
 Pinces à disséquer et à ligatures
 Pinze per preparazioni e legature

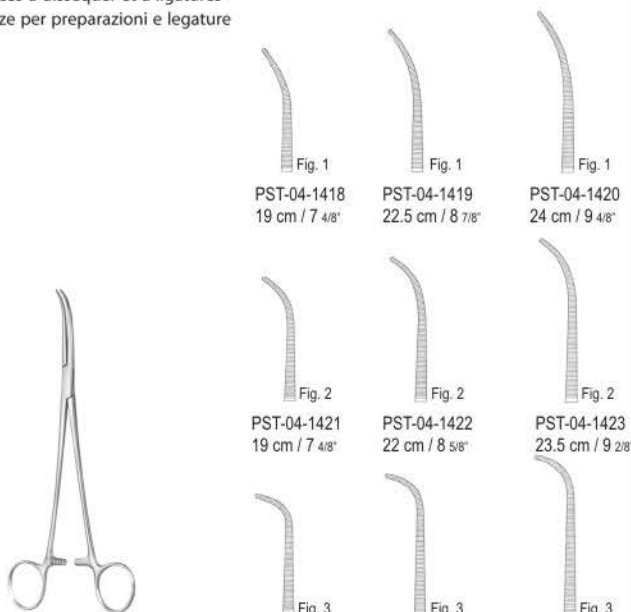

Fig. 1 PST-04-1418 19 cm / 7 4/8"
 Fig. 1 PST-04-1419 22.5 cm / 8 7/8"
 Fig. 1 PST-04-1420 24 cm / 9 4/8"

Fig. 2 PST-04-1421 19 cm / 7 4/8"
 Fig. 2 PST-04-1422 22 cm / 8 5/8"
 Fig. 2 PST-04-1423 23.5 cm / 9 2/8"

Fig. 3 PST-04-1424 18.5 cm / 7 2/8"
 Fig. 3 PST-04-1425 21.5 cm / 8 4/8"
 Fig. 3 PST-04-1426 23.5 cm / 9 2/8"

Kelly
 PST-04-1418 - PST-04-1426

Präparierklemmen, Arterienklemmen

Dissecting and Ligature Forceps, Haemostitic Forceps
 Pinzas para preparación y ligadura, Pinzas hemostáticas
 Pinces à disséquer et à ligatures, Pinces hémostatiques
 Pinze per preparazioni e legature, Pinze emostatiche

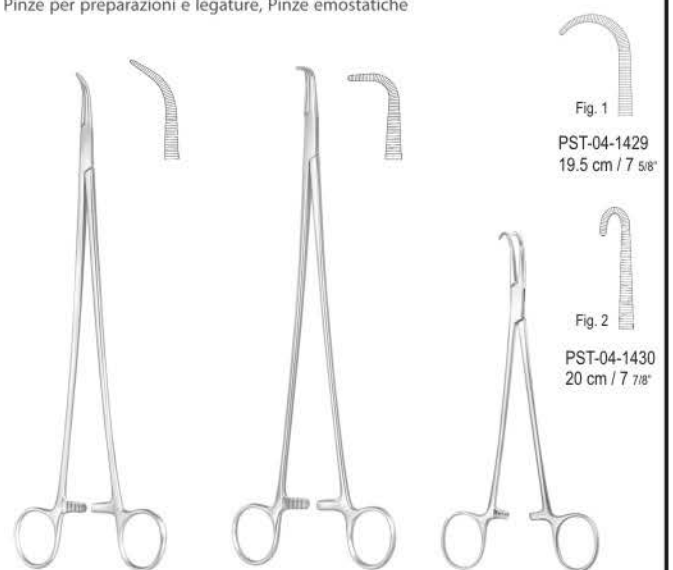

Fig. 1 PST-04-1429 19.5 cm / 7 5/8"

Fig. 2 PST-04-1430 20 cm / 7 7/8"

Lawrence
 PST-04-1427
 28 cm / 11"

Meeker
 PST-04-1428
 28 cm / 11"

Negus
 PST-04-1429 - PST-04-1430

Arterienklemmen
 Artery Forceps
 Pinzas Hemostaticas
 Pincas Hemostaticas
 Pinze emostatiche



Quality Instruments

Hysterektomieklemmen

Hysterectomy Forceps
 Pinzas para histerectomia
 Pincas à hystérectomie
 Pinze per isterectomia



Phaneuf
 PST-04-1431 - PST-04-1432

PST-04-1431
 20.5 cm / 8 1/8"

PST-04-1432
 20 cm / 7 7/8"

Fig. 1
 PST-04-1433
 19.5 cm / 7 5/8"

Fig. 1
 PST-04-1434
 21.5 cm / 8 4/8"

Fig. 1
 PST-04-1435
 24 cm / 9 4/8"



Heaney
 PST-04-1433 - PST-04-1438

Fig. 2
 PST-04-1436
 19.5 cm / 7 5/8"

Fig. 2
 PST-04-1437
 21.5 cm / 8 4/8"

Fig. 2
 PST-04-1438
 24 cm / 9 4/8"



Vaginalklemmen

Vaginal Clamp
 Pinzas vaginal
 Pincas vaginales
 Pinza vaginale



Wertheim-Cullen
 PST-04-1439
 21 cm / 8 2/8"



Hysterektomieklemmen

Hysterectomy Forceps
 Pinzas para histerectomia
 Pincas à hystérectomie
 Pinze per isterectomia



Rogers
 PST-04-1440 - PST-04-1446

Fig. 1
 PST-04-1440
 21.5 cm / 8 4/8"

Fig. 2
 PST-04-1441
 21 cm / 8 2/8"

Fig. 3
 PST-04-1442
 21 cm / 8 2/8"

Fig. 4
 PST-04-1443
 20.5 cm / 8 1/8"

Fig. 1
 PST-04-1444
 25.5 cm / 10"

Fig. 2
 PST-04-1445
 25 cm / 9 7/8"

Fig. 3
 PST-04-1446
 24.5 cm / 9 4/8"



Gallenkanalklemmen

Bile Duct Clamps
 Pinzas para conducto biliar
 Pincas pour les voies biliaires
 Pinze per vie biliari



Moynihan
 PST-04-1447
 23 cm / 9"



Moynihan
 PST-04-1448
 23.5 cm / 9 2/8"



Arterienklemmen
Artery Forceps
Pinzas Hemostaticas
Pinces Hemostatiques
Pinze emostatiche 04



Quality Instruments

Hysterektomieklemmen

Hysterectomy Forceps
 Pinzas para histerectomia
 Pinces à hystérectomie
 Pinze per isterectomia

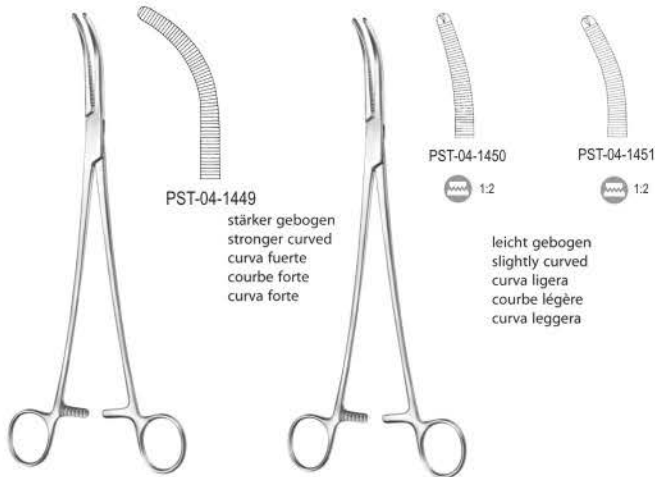

Wertheim
 PST-04-1449
 26 cm / 10 7/8"

Wertheim
 PST-04-1450 - PST-04-1451
 22.5 cm / 8 7/8"

stärker gebogen
 stronger curved
 curva fuerte
 courbe forte
 curva forte

leicht gebogen
 slightly curved
 curva ligera
 courbe légère
 curva leggera

Peritoneumklemmen

Peritoneum Forceps
 Pinzas para peritoneo
 Pince pour le péritoine
 Pinze per peritoneo

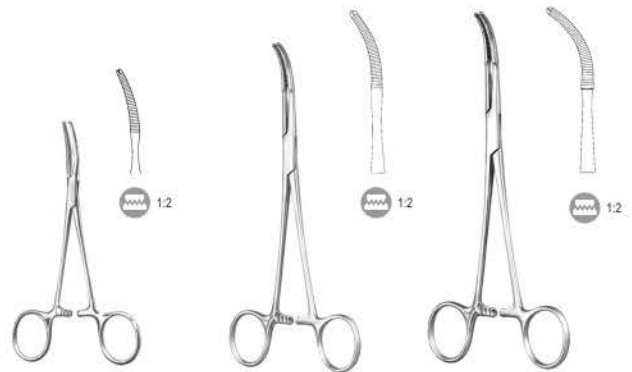

Mikulicz-Baby
 PST-04-1452
 14.5 cm / 5 6/8"

Mikulicz
 PST-04-1453
 18.5 cm / 7 2/8"

Mikulicz
 PST-04-1454
 20 cm / 7 7/8"

Peritoneumklemmen

Peritoneum Forceps
 Pinzas para peritoneo
 Pince pour le péritoine
 Pinze per peritoneo



Mikulicz
 PST-04-1455
 20 cm / 7 7/8"

Faure
 PST-04-1456
 21 cm / 8 2/8"

Mikulicz
 PST-04-1457
 20.5 cm / 8 1/8"

Tuchklemmen

Towel Clamps
 Pinzas de campo
 Pinces à champs
 Pinze fissatele

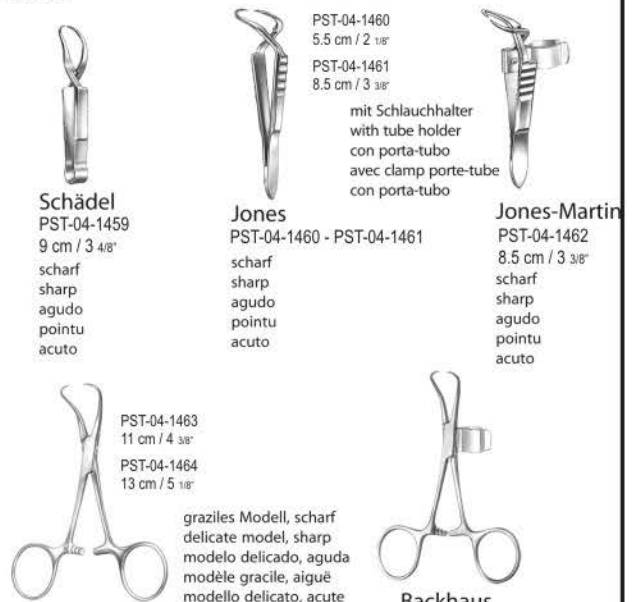

Schädel
 PST-04-1459
 9 cm / 3 4/8"
 scharf
 sharp
 agudo
 pointu
 acuto

Jones
 PST-04-1460 - PST-04-1461
 scharf
 sharp
 agudo
 pointu
 acuto

Jones-Martin
 PST-04-1462
 8.5 cm / 3 3/8"
 scharf
 sharp
 agudo
 pointu
 acuto

Backhaus
 PST-04-1463 - PST-04-1464
 graziles Modell, scharf
 delicate model, sharp
 modelo delicado, aguda
 modèle gracie, aiguë
 modello delicato, acute

Backhaus
 PST-04-1465
 11 cm / 4 3/8"

Arterienklemmen
 Artery Forceps
 Pinzas Hemostaticas
 Pinces Hemostatiques
 Pinze emostatiche 04



Quality Instruments

Tuchklemmen

Towel Clamps
 Pinzas de campo
 Pinces à champs
 Pinze fissatele



PST-04-1466
 9 cm / 3 1/8"

PST-04-1467
 11 cm / 4 3/8"

PST-04-1468
 13 cm / 5 1/8"

Backhaus

PST-04-1466 - PST-04-1468

scharf
 sharp
 agudo
 pointu
 acuto



Roeder

PST-04-1470
 13.5 cm / 5 3/8"



Peers-Bertram modif.

PST-04-1469

15.5 cm / 6"
 weites Maul zur Schlauchfixierung
 wide jaw for tube fixation
 boca ancha para fijación de tubos
 mors large pour fixation de tube
 morso spalancato per fissare il tubo



Tuchklemmen

Towel Clamps
 Pinzas de campo
 Pinces à champs
 Pinze fissatele



PST-04-1471
 10 cm / 3 7/8"
 PST-04-1472
 13 cm / 5 1/8"
 fein gezahnt, breites Maul
 fine serrated, wide jaw
 delicadamente dentada, boca ancha
 avec dents fins, mors large
 con denti fini, morso largo

Lorna

PST-04-1471 - PST-04-1472



Tohoku

PST-04-1474 - PST-04-1475

stumpf
 blunt
 romo
 mousse
 PST-04-1474
 10.5 cm / 4 1/8"
 PST-04-1475
 smusso
 13.5 cm / 5 3/8"



scharf
 sharp
 agudo
 pointu
 acuto

Bernhard

PST-04-1473
 16.5 cm / 6 4/8"

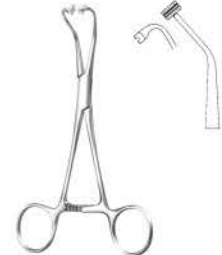

Peers-Bertram

PST-04-1476
 14.5 cm / 5 6/8"



Tuchklemmen

Towel Clamps
 Pinzas de campo
 Pinces à champs
 Pinze fissatele

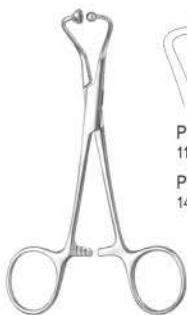

PST-04-1477
 11.5 cm / 4 4/8"

PST-04-1478
 14 cm / 5 4/8"

PST-04-1477 - PST-04-1478
 für Papierabdeckung
 for paper clothes
 para paños de papel
 pour couverture en papier
 per copertura di carta



Lane

PST-04-1479
 19.5 cm / 3 5/8"



Tupfer and kornzeggen

Cotton Swep Forceps etc
Pinzas Para tapones y- curaciones
Pincas Tampons et à Pansements
Pinze per Tamponi e per Medicazione

05



Quality Instruments

Tupferzangen

Dressing Forceps
Pinzas para tapones
Pincas à tampons
Pinze per tamponi

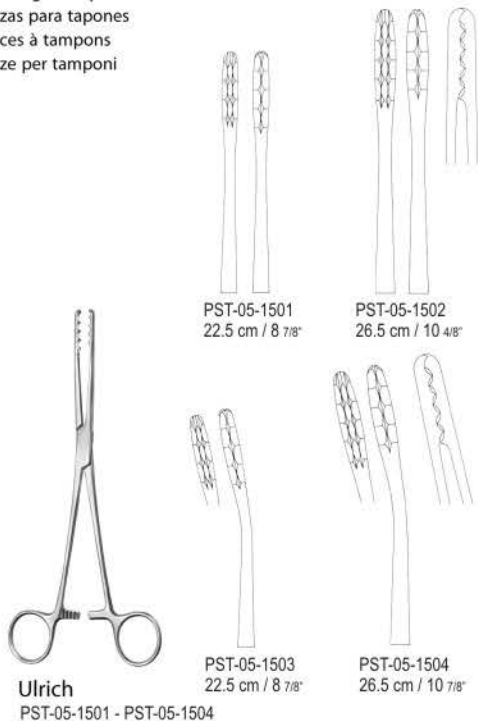

PST-05-1501
22.5 cm / 8 7/8"

PST-05-1502
26.5 cm / 10 4/8"

PST-05-1503
22.5 cm / 8 7/8"

PST-05-1504
26.5 cm / 10 7/8"

Ulrich
PST-05-1501 - PST-05-1504



Sinusklammen, Kornzangen

Sinus Forceps, Dressing Forceps
Pinzas para vendajes, Pinzas para vendajes
Pincas Sinus, Pincas à pansements
Pinze per seni, Pinze per medicature

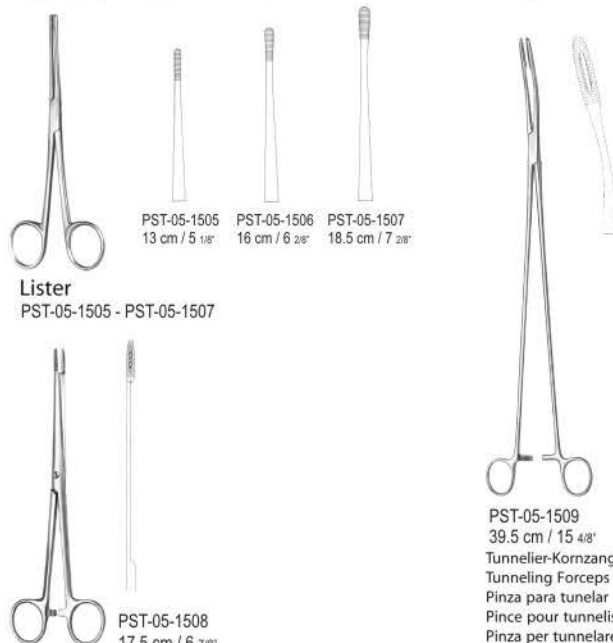

PST-05-1505
13 cm / 5 1/8"

PST-05-1506
16 cm / 6 2/8"

PST-05-1507
18.5 cm / 7 2/8"

Lister
PST-05-1505 - PST-05-1507

PST-05-1508
17.5 cm / 6 7/8"

PST-05-1509
39.5 cm / 15 4/8"
Tunnelier-Kornzange
Tunneling Forceps
Pinza para tunelar
Pinze pour tunnelisation
Pinza per tunnelare



Kornzangen

Dressing Forceps
Pinzas para vendajes
Pincas à pansements
Pinze per medicature

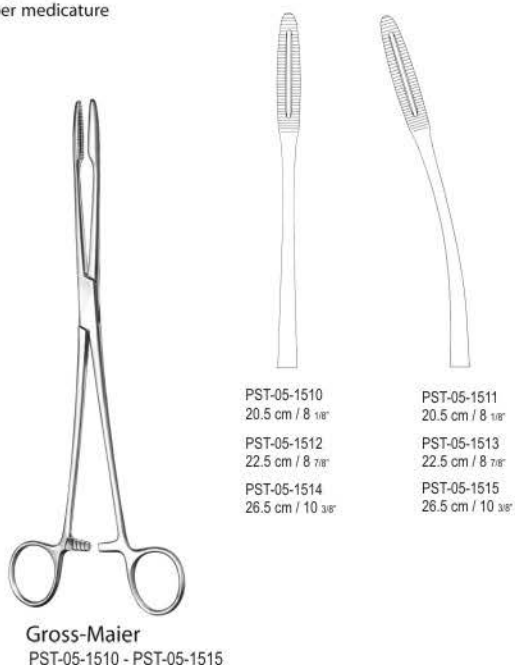

PST-05-1510
20.5 cm / 8 1/8"

PST-05-1511
20.5 cm / 8 1/8"

PST-05-1512
22.5 cm / 8 7/8"

PST-05-1513
22.5 cm / 8 7/8"

PST-05-1514
26.5 cm / 10 3/8"

PST-05-1515
26.5 cm / 10 3/8"

Gross-Maier
PST-05-1510 - PST-05-1515



Kornzangen

Dressing Forceps
Pinzas para vendajes
Pincas à pansements
Pinze per medicature

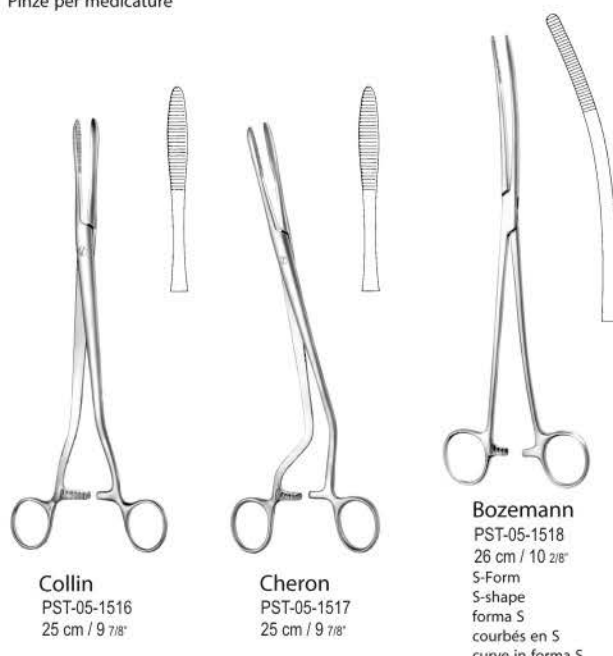

Collin
PST-05-1516
25 cm / 9 7/8"

Cheron
PST-05-1517
25 cm / 9 7/8"

Bozemann
PST-05-1518
26 cm / 10 2/8"
S-Form
S-shape
forma S
courbés en S
curve in forma S



**Tupfer and
kornzeggen** Cotton Swep Forceps etc
Pinzas Para tapones y- curaciones 05
Pincas Tampons et à Pansements
Pinze per Tamponi e per Medicazione



Quality Instruments

Schwammzangen

Sponge Forceps
Pinzas para tapones
Pincas pour éponges
Pinze per tamponi e sponge



Bergmann
PST-05-1519
24 cm / 9 4/8"

Schwammzangen

Sponge Forceps
Pinzas para tapones
Pincas pour éponges
Pinze per tamponi e sponge

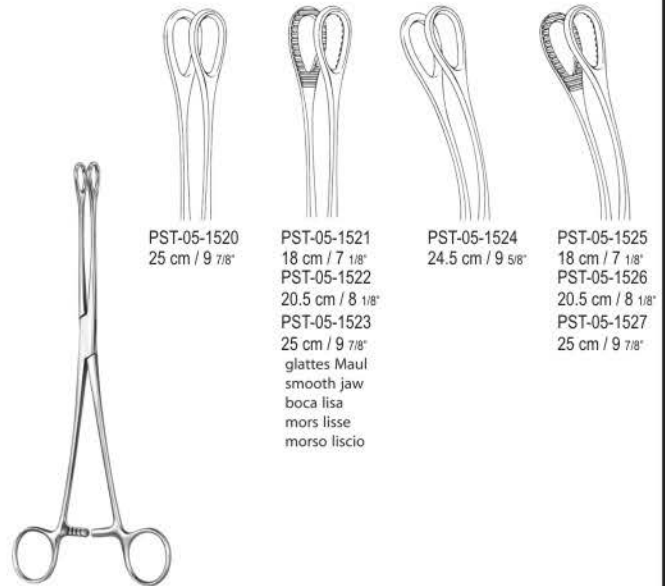

PST-05-1520
25 cm / 9 7/8"

PST-05-1521
18 cm / 7 1/8"

PST-05-1522
20.5 cm / 8 1/8"

PST-05-1523
25 cm / 9 7/8"

glattes Maul
smooth jaw
boca lisa
mors lisse
morso liscio

PST-05-1524
24.5 cm / 9 5/8"

PST-05-1525
18 cm / 7 1/8"

PST-05-1526
20.5 cm / 8 1/8"

PST-05-1527
25 cm / 9 7/8"

Förster
PST-05-1520 - PST-05-1527

Schwammzangen

Sponge Forceps
Pinzas para tapones
Pincas pour éponges
Pinze per tamponi e sponge

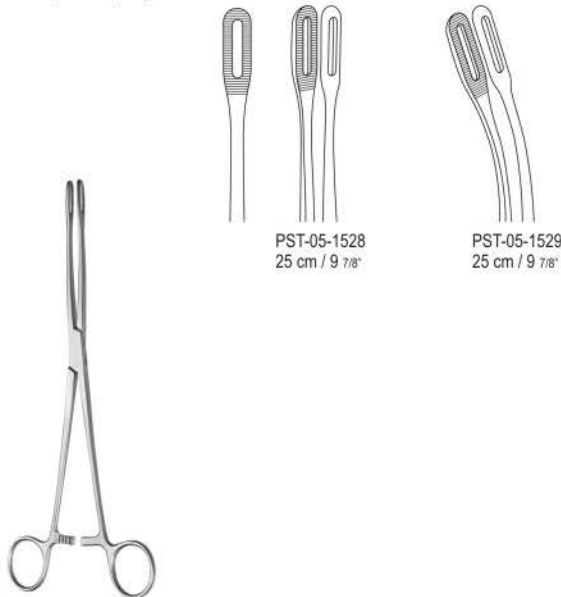

PST-05-1528
25 cm / 9 7/8"

PST-05-1529
25 cm / 9 7/8"

Förster
PST-05-1528 - PST-05-1529

Schwammzangen

Sponge Forceps
Pinzas para tapones
Pincas pour éponges
Pinze per tamponi e sponge



PST-05-1530
18 cm / 7 1/8"

PST-05-1531
25 cm / 9 7/8"

Rampley
PST-05-1530 - PST-05-1531



Wundhaken
Retractors
Separadores
Ecarteurs
Divaricatori



06

51 - 72

Sonden Watteträger Spatel
Probes, Applicators, Spatulas
Sondas, Porta-algodones, Espátulas
Sondes, Porte-Cotons, Spatules
Sonde, Portacotoni, Spatole

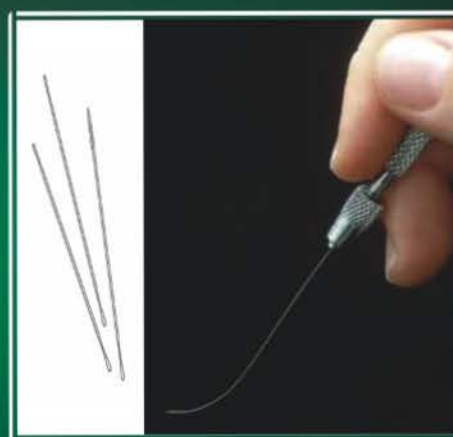

07

73

Diagnostik
Diagnostics
Diagnóstico
Diagnostic
Diagnostica



08

74 - 76

Wundhaken
Retractors
Separadores
Ecarteurs
Divaricatori

06



Quality Instruments

Mikrohäkchen, Hauthäkchen

Micro Hooklets, Skin Hooks
Micro Ganchitos, Ganchitos de piel
Micro Crochetes, Crochetes pour le peau
Micro Divaricatori, Divaricatori per pelle

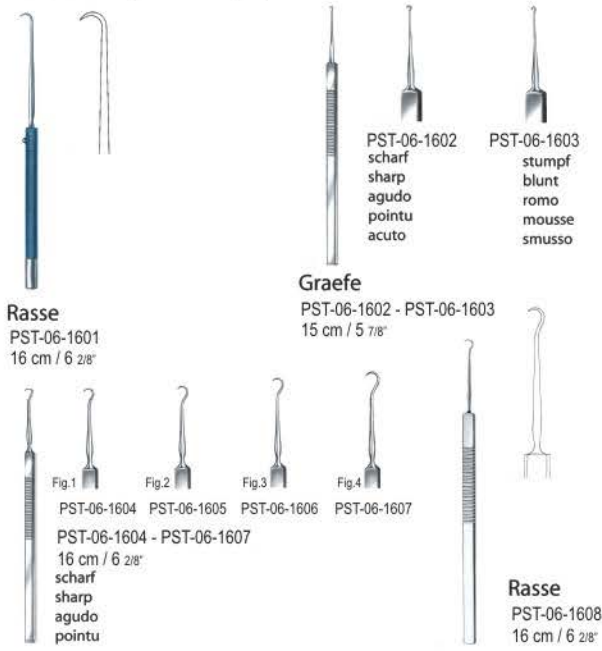

Hauthäkchen, Wundhaken

Skin Hooks, Hooklets
Ganchitos de piel, Ganchitos
Crochetes pour le peau, Crochetes
Divaricatori per pelle, Divaricatori

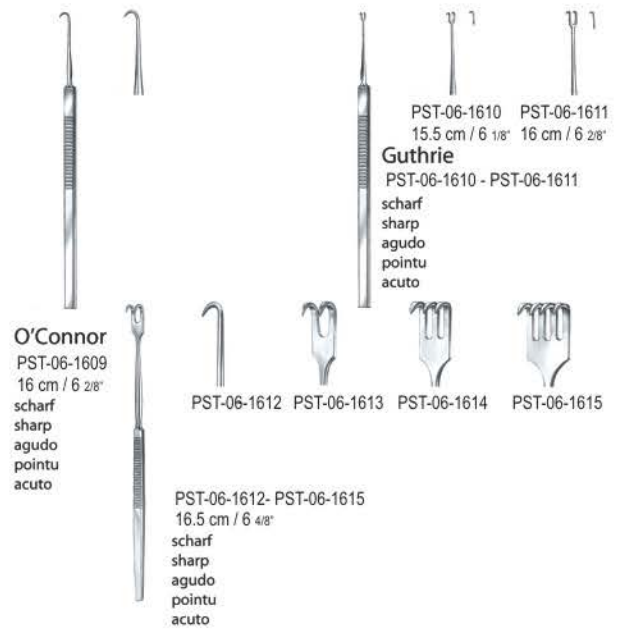

Wundhäkchen

Hooklets
Ganchitos
Crochetes
Divaricatori

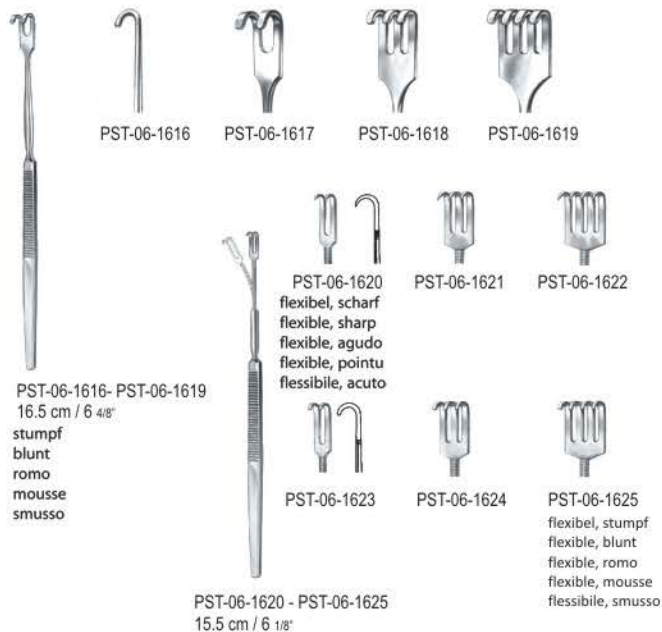

Wundhäkchen, Sattelhäkchen

Hooklets, Saddle Hooks
Ganchitos, Ganchos en forma de silla
Crochetes, Ecarteurs sous forme de selle
Divaricatori, Divaricatori a forma di sella

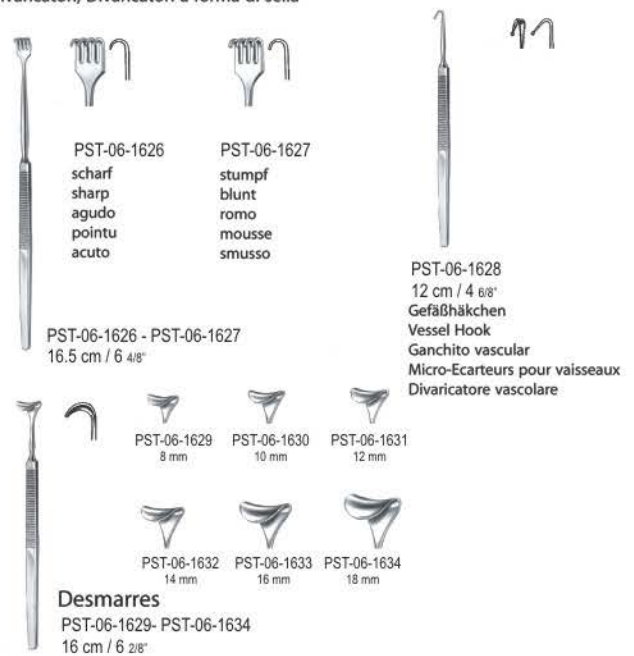

Wundhaken
Retractors
Separadores
Ecarteurs
Divaricatori

06



Quality Instruments

Sattelhäkchen

Saddle Hooks
Ganchos en forma de silla
Ecarteurs sous forme de selle
Divaricatori a forma di sella



PST-06-1635
12 mm



PST-06-1636
14 mm



PST-06-1637
16 mm



PST-06-1638
18 mm



PST-06-1639
12 x 6 mm



PST-06-1640
18 x 6 mm



PST-06-1641
20 x 6 mm



PST-06-1642
21 x 8 mm

Langenbeck-Mini
PST-06-1639- PST-06-1642
16 cm / 6 2/8"

PST-06-1635 - PST-06-1638
16 cm / 6 2/8"



Wundhäkchen

Hooklets
Ganchitos
Crochetes
Divaricatori



PST-06-1644



PST-06-1645



PST-06-1646



PST-06-1647



PST-06-1643
14 X 8 mm

scharf
sharp
agudo
pointu
acuto

PST-06-1644 - PST-06-1647
16.5 cm / 6 4/8"



PST-06-1648



PST-06-1649



PST-06-1650



PST-06-1651

PST-06-1643
16 cm / 6 2/8"
stumpf
blunt
romo
mousse
smusso

PST-06-1648 - PST-06-1651
16.5 cm / 6 4/8"
stumpf
blunt
romo
mousse
smusso



Wundhäkchen

Hooklets
Ganchitos
Crochetes
Divaricatori



Fig. 1
PST-06-1652

stumpf
blunt
romo
mousse
smusso
18 x 7 mm



Fig. 2
PST-06-1653

gezahnt
toothed
dentadas
dentelés
dentate
dentadas
16 x 5 mm



Fig. 3
PST-06-1654

gezahnt
toothed
dentadas
dentelés
dentate
7 x 4 mm



Fig. 4
PST-06-1655

stumpf
blunt
romo
mousse
smusso
12 x 4 mm



Fig. 5
PST-06-1656

sattelförmig
saddle shaped
forma de silla
sous forme de selle
8 x 4 mm



Fig. 6
PST-06-1657

scharf
sharp
agudo
pointu
acuto
7 x 9 mm



Meyerding
PST-06-1652 - PST-06-1657
16 cm / 7 1/8"



Wundhäkchen

Hooklets
Ganchitos
Crochetes
Divaricatori



Fig. 1
PST-06-1658
20 x 6 mm



Fig. 2
PST-06-1659
10 x 6 mm

Senn-Green
PST-06-1658 - PST-06-1659
16 cm / 6 2/8"



8 x 4.5 mm

PST-06-1660

15 x 5.5 mm

Ragnell-Davis
PST-06-1660
15 cm / 5 7/8"



Senn-Miller
PST-06-1661 - 1662
16 cm / 6 2/8"

PST-06-1661
scharfe Zähne
sharp prongs
gafios agudos
dents pointus
denti acuti
20 x 7 mm

PST-06-1662
Blätter
blades
hojas
lames
lame
20 x 7 mm



Cushing
PST-06-1663
20.5 cm / 8 1/8"



Wundhaken
Retractors
Separadores
Ecarteurs
Divaricatori

06



Quality Instruments

Sattelhäkchen

Saddle Hooks
 Ganchos en forma de silla
 Ecarteurs sous forme de selle
 Divaricatori a forma di sella

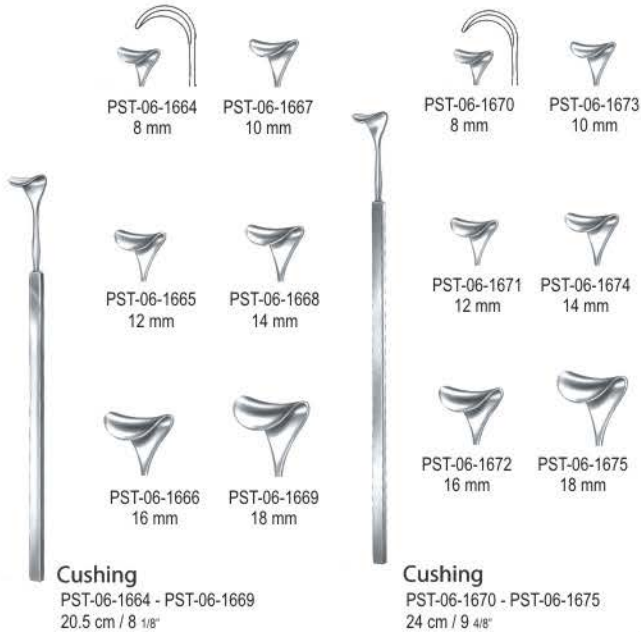

Sattelhäkchen

Saddle Hooks
 Ganchos en forma de silla
 Ecarteurs sous forme de selle
 Divaricatori a forma di sella

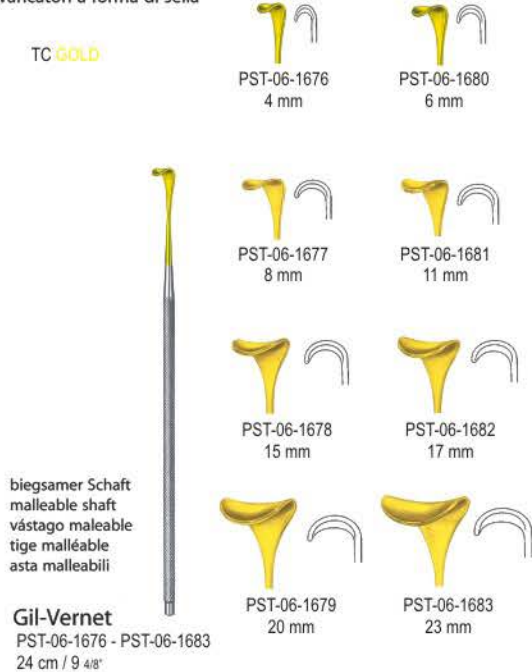

Venenhäkchen, Wundhäkchen

Vein Hooks
 Ganchitos para venas
 Ecarteurs pour veines
 Divaricatori per veni



Wundhaken, Wundhäkchen

Retractors
 Separadores
 Ecarteurs
 Divaricatori



Wundhaken
Retractors
Separadores
Ecarteurs
Divaricatori

06



Quality Instruments

Wundhaken
Retractors
Separadores
Ecarteurs
Divaricatori

PST-06-1694 PST-06-1695 PST-06-1696 PST-06-1697 PST-06-1698

scharf
sharp
agudo
pointu
acuto

PST-06-1699 PST-06-1700 PST-06-1701 PST-06-1702 PST-06-1703

stumpf
blunt
romo
mousse
smusso

Volkmann
PST-06-1694 - PST-06-1703
21.5 cm / 8 4/8"

Wundhaken
Retractors
Separadores
Ecarteurs
Divaricatori

PST-06-1704 PST-06-1705 PST-06-1706 PST-06-1707 PST-06-1708

scharf
sharp
agudo
pointu
acuto

PST-06-1709 PST-06-1710 PST-06-1711 PST-06-1712 PST-06-1713

stumpf
blunt
romo
mousse
smusso

PST-06-1714 PST-06-1715 PST-06-1716 PST-06-1717 PST-06-1718

halbscharf
semi-sharp
semi-agudo
semi-pointu
semi-acuto

Volkmann
PST-06-1704 - PST-06-1718
22 cm / 8 5/8"

Wundhaken
Retractors
Separadores
Ecarteurs
Divaricatori

PST-06-1719 PST-06-1720 PST-06-1721

scharf
sharp
agudo
pointu
acuto

stumpf
blunt
romo
mousse
smusso

scharf
sharp
agudo
pointu
acuto

Volkmann
PST-06-1719
21.5 cm / 8 4/8"

Volkmann
PST-06-1720
21.5 cm / 8 4/8"

Volkmann
PST-06-1721
21.5 cm / 8 4/8"

Wundhaken
Retractors
Separadores
Ecarteurs
Divaricatori

PST-06-1722 PST-06-1723 PST-06-1724 PST-06-1725 PST-06-1726 PST-06-1727

scharf
sharp
agudo
pointu
acuto

PST-06-1728 PST-06-1729 PST-06-1730 PST-06-1731 PST-06-1732 PST-06-1733

stumpf
blunt
romo
mousse
smusso

PST-06-1734 PST-06-1735 PST-06-1736 PST-06-1737 PST-06-1738 PST-06-1739

halbscharf
semi-sharp
semi-agudo
semi-pointu
semi-acuto

Kocher
PST-06-1722 - PST-06-1739
22 cm / 8 5/8"

Wundhaken
Retractors
Separadores
Ecarteurs
Divaricatori

06



Quality Instruments

Wundhaken
Retractors
Separadores
Ecarteurs
Divaricatori

PST-06-1740 PST-06-1741 PST-06-1742 PST-06-1743

PST-06-1744 PST-06-1745 PST-06-1746 PST-06-1747

scharf
sharp
agudo
pointu
acuto

stumpf
blunt
romo
mousse
smusso

Martin
PST-06-1740 - PST-06-1647
22.5 cm / 8 7/8"

Wundhaken
Retractors
Separadores
Ecarteurs
Divaricatori

Ollier
PST-06-1748
24.5 cm / 9 5/8"
stumpf
blunt
romo
mousse
smusso
37 x 30 mm

Ollier
PST-06-1749
23 cm / 9"
stumpf
blunt
romo
mousse
smusso
39 x 60 mm

Wundhaken
Retractors
Separadores
Ecarteurs
Divaricatori

Wassmund
PST-06-1750
20.5 cm / 8 1/8"
33 x 20 mm

Körte
PST-06-1751
24.5 cm / 9 5/8"
scharf
sharp
agudo
pointu
acuto
25 x 40 mm

Körte
PST-06-1752
24.5 cm / 9 5/8"
stumpf
blunt
romo
mousse
smusso
25 x 30 mm

Wundhaken
Retractors
Separadores
Ecarteurs
Divaricatori

Israel
PST-06-1753 - 1756
70 x 70 mm
24.5 cm / 9 5/8"
stumpf
blunt
romo
mousse
smusso

PST-06-1753
40 x 40 mm

PST-06-1754
45 x 50 mm

PST-06-1755
50 x 60 mm

Wundhaken
Retractors
Separadores
Ecarteurs
Divaricatori

06



Quality Instruments

Wundhaken
Retractors
Separadores
Ecarteurs
Divaricatori

Langenbeck
PST-06-1757 - PST-06-1761
22 cm / 8 5/8"

Langenbeck
PST-06-1762 - PST-06-1766
22 cm / 8 5/8"

Wundhaken
Retractors
Separadores
Ecarteurs
Divaricatori

Langenbeck
PST-06-1767
21 cm / 8 2/8"

Langenbeck
PST-06-1768
22.5 cm / 8 7/8"

Wundhaken
Retractors
Separadores
Ecarteurs
Divaricatori

Lahey
PST-06-1769
19.5 cm / 7 5/8"

Little
PST-06-1770
20.5 cm / 8 1/8"

Wundhaken
Retractors
Separadores
Ecarteurs
Divaricatori

Kocher
PST-06-1771 - PST-06-1775
23 mm / 9"



Wundhaken
Retractors
Separadores
Ecarteurs
Divaricatori

06



Quality Instruments

Wundhaken
Retractors
Separadores
Ecarteurs
Divaricatori



PST-06-1776
25 x 6 mm

PST-06-1777
25 x 8 mm

PST-06-1778
35 x 11 mm

PST-06-1779
35 x 15 mm

PST-06-1780
40 x 11 mm

PST-06-1781
55 x 11 mm

PST-06-1782
70 x 14 mm

PST-06-1783
80 x 12 mm

PST-06-1784
80 x 16 mm

Kocher-Langenbeck
PST-06-1776 - PST-06-1784
21.5 cm / 8 4/8"

★★★★★

Wundhaken
Retractors
Separadores
Ecarteurs
Divaricatori



PST-06-1785
25 x 10 mm

PST-06-1786
40 x 13 mm

PST-06-1787
60 x 13 mm

PST-06-1788
40 x 18 mm

PST-06-1789
60 x 18 mm

PST-06-1790
85 x 18 mm

PST-06-1791
60 x 25 mm

PST-06-1792
85 x 25 mm

Kocher-Langenbeck
PST-06-1785 - PST-06-1792
21.5 cm / 8 4/8"

★★★★★

Wundhaken
Retractors
Separadores
Ecarteurs
Divaricatori



PST-06-1793
18 cm / 7"
10 x 3 mm

PST-06-1794
25 cm / 9 3/8"
35 x 8 mm

PST-06-1795
26.5 cm / 10 2/8"
60 x 12 mm

PST-06-1796
27.5 cm / 10 6/8"
75 x 12 mm



PST-06-1797
28.5 cm / 11 2/8"
85 x 20 mm

PST-06-1798
30.5 cm / 12"
100 x 25 mm

Zenker
PST-06-1793 - PST-06-1798

★★★★★

Wundhaken
Retractors
Separadores
Ecarteurs
Divaricatori

PST-06-1799
20 x 12 mm

PST-06-1800
23 x 14 mm

PST-06-1801
22 cm / 8 5/8"
40 x 10 mm

PST-06-1802
23 cm / 9"
40 x 15 mm

PST-06-1803
23 cm / 9"
40 x 20 mm

Kocher
PST-06-1799 - PST-06-1800
21.5 cm / 8 4/8"

Kocher
PST-06-1801 - PST-06-1803

★★★★★

Wundhaken
Retractors
Separadores
Ecarteurs
Divaricatori

06



Quality Instruments

Wundhaken
Retractors
Separadores
Ecarteurs
Divaricatori

PST-06-1804
22 cm / 8 5/8"
15 x 17 mm

PST-06-1805
23 cm / 9"
22 x 22 mm

PST-06-1806
24 cm / 9 4/8"
26 x 31 mm

Fig. 1
PST-06-1807
26 cm / 10 2/8"
25 x 20 mm
30 x 28 mm

Fig. 2
PST-06-1808
26 cm / 10 2/8"
43 x 38 mm
63 x 44 mm

Middeldorpf
PST-06-1804 - PST-06-1806

Richardson-Eastman
PST-06-1807 - PST-06-1808

Wundhaken
Retractors
Separadores
Ecarteurs
Divaricatori

PST-06-1809
23.5 cm / 9 2/8"
25 x 21 mm

PST-06-1810
24 cm / 9 4/8"
30 x 29 mm

PST-06-1811
24 cm / 9 4/8"
38 x 40 mm

Richardson
PST-06-1809
48 x 22 mm

Richardson
PST-06-1812
24 cm / 9 4/8"
62 x 50 mm

Kelly
PST-06-1813
26 cm / 10 2/8"

Wundhaken
Retractors
Separadores
Ecarteurs
Divaricatori

PST-06-1814
25 cm / 9 7/8"
87 x 28 mm

PST-06-1815
25 cm / 9 7/8"
97 x 31 mm

PST-06-1816
26 cm / 10 1/8"
117 x 52 mm

Doyen-Stille
PST-06-1814 - 1816

Wundhaken
Retractors
Separadores
Ecarteurs
Divaricatori

PST-06-1817
63 x 21 mm

PST-06-1818
83 x 30 mm

PST-06-1819
103 x 30 mm

PST-06-1820
120 x 30 mm

PST-06-1821
140 x 30 mm

PST-06-1822
140 x 40 mm

Hösel
PST-06-1817 - PST-06-1822
26 cm / 10 2/8"



Wundhaken
Retractors
Separadores
Ecarteurs
Divaricatori

06



Quality Instruments

Wundhaken
Retractors
Separadores
Ecarteurs
Divaricatori

PST-06-1823
27 cm / 10 5/8"
43 x 45 mm

PST-06-1824
27 cm / 10 5/8"
52 x 50 mm

PST-06-1825
28 cm / 11"
52 x 70 mm

Middeldorpf
PST-06-1823 - PST-06-1825



Wundhaken
Retractors
Separadores
Ecarteurs
Divaricatori

PST-06-1826
28.5 cm / 9 23/32"
37 x 31 mm

PST-06-1827
24 cm / 9 4/8"
38 x 40 mm

PST-06-1828
25 cm / 9 6/8"
43 x 51 mm

PST-06-1829
25 cm / 9 6/8"
49 x 61 mm

PST-06-1830
25.5 cm / 10"
48 x 75 mm

PST-06-1831
29.5 cm / 10 4/8"
65 x 85 mm

Fritsch
PST-06-1826

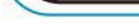

Wundhaken
Retractors
Separadores
Ecarteurs
Divaricatori

PST-06-1834
78 x 45 mm

PST-06-1835
78 x 55 mm

PST-06-1836
78 x 65 mm

Doyen
PST-06-1832
24 cm / 9 4/8"
45 x 88 mm

Kocher
PST-06-1833
24 cm / 9 4/8"
70 x 25 mm

Kocher
PST-06-1834 - 1836
25 cm / 9 7/8"



Wundhaken
Retractors
Separadores
Ecarteurs
Divaricatori

PST-06-1838
110 x 27 mm

PST-06-1839
115 x 22 mm

PST-06-1840
115 x 28 mm

Martin
PST-06-1837
26.5 cm / 10 3/8"

Simon
PST-06-1838 - PST-06-1840
28 cm / 11"



Wundhaken

Retractors
Separadores
Ecarteurs
Divaricatori

06



Quality Instruments

Wundhaken

Retractors
Separadores
Ecarteurs
Divaricatori



PST-06-1841
119 x 65 mm

PST-06-1842
108 x 43 mm

PST-06-1843
80 x 22 mm



Coryllos
PST-06-1841 - PST-06-1843
24 cm / 9 4/8"



Scapulahaken

Scapula Retractors
Separadores para escapula
Ecarteurs pour scapula
Divaricatori per scapola



Davidson
PST-06-1844
19 cm / 7 4/8"
80 x 54 mm
80 x 54 mm



Davidson
PST-06-1845
18.5 cm / 7 2/8"
75 x 93 mm

Wundhaken

Retractors
Separadores
Ecarteurs
Divaricatori



PST-06-1846
125 x 38 mm

Sauerbruch
PST-06-1846
25.5 cm / 10"



Wundhaken

Retractors
Separadores
Ecarteurs
Divaricatori

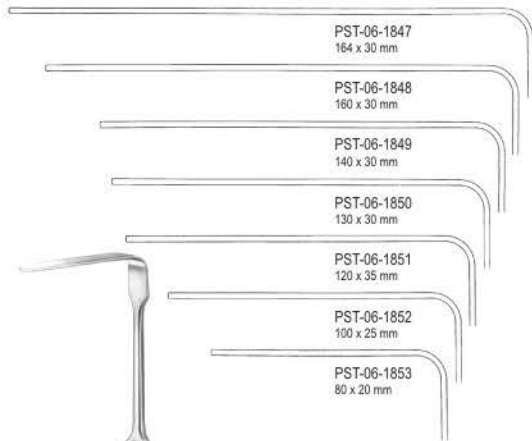

PST-06-1847
164 x 30 mm

PST-06-1848
160 x 30 mm

PST-06-1849
140 x 30 mm

PST-06-1850
130 x 30 mm

PST-06-1851
120 x 35 mm

PST-06-1852
100 x 25 mm

PST-06-1853
80 x 20 mm



Brunner
PST-06-1847 - PST-06-1853
25.5 cm / 10"



Wundhaken

Retractors
Separadores
Ecarteurs
Divaricatori

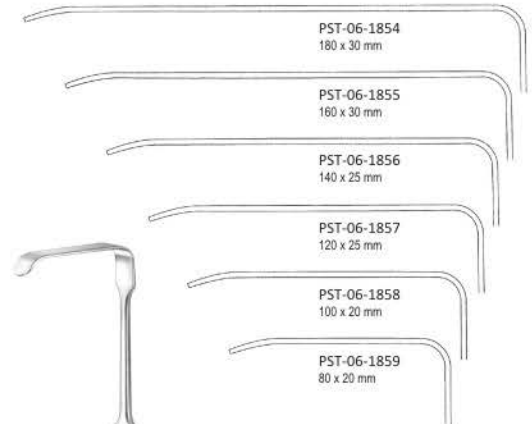

PST-06-1854
180 x 30 mm

PST-06-1855
160 x 30 mm

PST-06-1856
140 x 25 mm

PST-06-1857
120 x 25 mm

PST-06-1858
100 x 20 mm

PST-06-1859
80 x 20 mm



Brunner
PST-06-1854 - PST-06-1859
25.5 cm / 10"



Wundhaken
 Retractors
 Separadores
 Ecarteurs
 Divaricatori

06



Quality Instruments

Wundhaken
 Retractors
 Separadores
 Ecarteurs
 Divaricatori

PST-06-1860
45 x 15 mm

PST-06-1861
60 x 23 mm

PST-06-1862
72 x 20 mm

Sauerbruch
 PST-06-1860 - PST-06-1862
 22.5 cm / 8 7/8"

Aortahaken
 Aorta Retractors
 Separadores para aorta
 Ecarteurs pour aorta
 Divaricatori per aorta

Fig. 1
PST-06-1862
24 cm / 9 4/8"

Fig. 2
PST-06-1863
24.5 cm / 9 6/8"

Fig. 3
PST-06-1864
25 cm / 9 7/8"

Fig. 4
PST-06-1865
25.5 cm / 10"

Fig. 5
PST-06-1866
27 cm / 10 5/8"

Fig. 6
PST-06-1867
25.5 cm / 10"

Ross
 PST-06-1863 - PST-06-1867
 flexibler Schaft
 flexible shaft
 vástago flexible
 tige flexible
 asta flessibile

Wundhaken
 Retractors
 Separadores
 Ecarteurs
 Divaricatori

PST-06-1868
60 mm

Polloson
 PST-06-1868
 29 cm / 11 3/8"

Wundhaken
 Retractors
 Separadores
 Ecarteurs
 Divaricatori

PST-06-1869
60 mm

Polloson
 PST-06-1869
 26 cm / 10 4/8"

Wundhaken

Retractors
Separadores
Ecarteurs
Divaricatori

06



Quality Instruments

Wundhaken
Retractors
Separadores
Ecarteurs
Divaricatori

PST-06-1870
32.5 cm / 12 5/8"
137 x 44 mm

PST-06-1871
33 cm / 13"
137 x 65 mm

Harrington
PST-06-1870 - PST-06-1871

Wundhaken
Retractors
Separadores
Ecarteurs
Divaricatori

Deaver
PST-06-1872
18 cm / 7 1/8"
19 mm

Deaver
PST-06-1873
21.5 cm / 8 4/8"
22 mm

Deaver
PST-06-1874
21.5 cm / 9 5/8"
25 mm

Deaver
PST-06-1875
30.5 cm / 12"
25 mm

Deaver
PST-06-1876
33.5 cm / 13 2/8"
25 mm

Deaver
PST-06-1877
34.5 cm / 13 5/8"
25 mm

Wundhaken
Retractors
Separadores
Ecarteurs
Divaricatori

Deaver
PST-06-1878
32 cm / 12 5/8"
38 mm

Deaver
PST-06-1879
31.5 cm / 12 3/8"
50 mm

Deaver
PST-06-1880
31.5 cm / 12 3/8"
75 mm

Wundhaken
Retractors
Separadores
Ecarteurs
Divaricatori

PST-06-1881
31.5 cm / 12 3/8"
25 mm

PST-06-1882
31.5 cm / 12 3/8"
38 mm

PST-06-1883
31.5 cm / 12 3/8"
50 mm

PST-06-1884
32.5 cm / 12 5/8"
100 mm

Deaver
PST-06-1881 - PST-06-1884



Wundhaken
Retractors
Separadores
Ecarteurs
Divaricatori

06



Quality Instruments

Atriumhaken
Atrium Retractors
Separadores para atrio
Ecarteurs pour atrium
Divaricatori per atrio

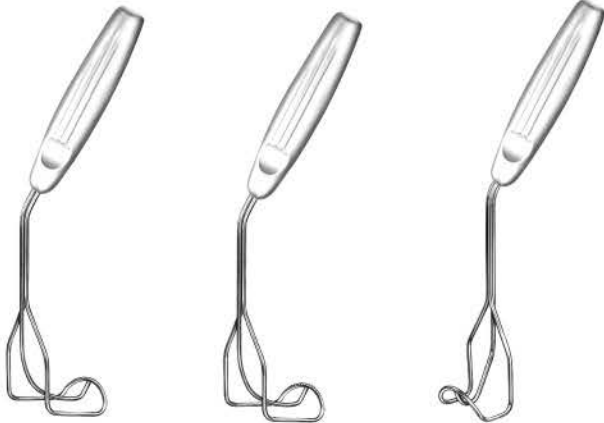

Cooley

PST-06-1885
25 cm / 9 7/8"
rechts
right
derecho
droit
destra
48 x 48 mm

Cooley

PST-06-1886
25 cm / 9 7/8"
rechts, gerieft
right, serrated
derecho, estriado
droit, avec stries
destra, con striatura
48 x 48 mm

Cooley

PST-06-1887
27.5 cm / 10 7/8"
links
left
izquierdo
gauche
sinistra
30 x 48 mm

Wundhaken
Retractors
Separadores
Ecarteurs
Divaricatori

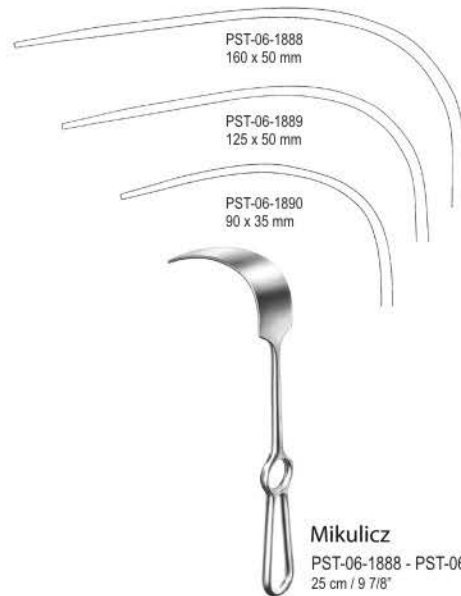

PST-06-1888
160 x 50 mm

PST-06-1889
125 x 50 mm

PST-06-1890
90 x 35 mm

Mikulicz

PST-06-1888 - PST-06-1890
25 cm / 9 7/8"

Wundhaken
Retractors
Separadores
Ecarteurs
Divaricatori



90 x 55 mm

PST-06-1892
27.5 cm / 10 7/8"
205 x 38 mm

PST-06-1893
28 cm / 11"
210 x 57 mm



Mikulicz
PST-06-1891
26 cm / 10 1/8"

Kelly
PST-06-1892 - PST-06-1893

Pelvishaken
Pelvis Retractors
Separadores para pelvis
Ecarteurs pour pelvis
Divaricatori per pelvis



St. Marks
PST-06-1894 - PST-06-1896



35 x 45 mm

PST-06-1894
26 cm / 10 1/8"
130 x 60 mm



60 x 45 mm

PST-06-1895
23.5 cm / 9 2/8"
180 x 60 mm

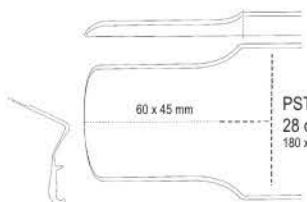

60 x 45 mm

PST-06-1896
28 cm / 11"
180 x 60 mm

Wundhaken

Retractors
Separadores
Ecarteurs
Divaricatori

06



Quality Instruments

Bauchspatel

Abdominal Spatulas
Espátulas abdominales
Spatules abdominales
Spatole addominali

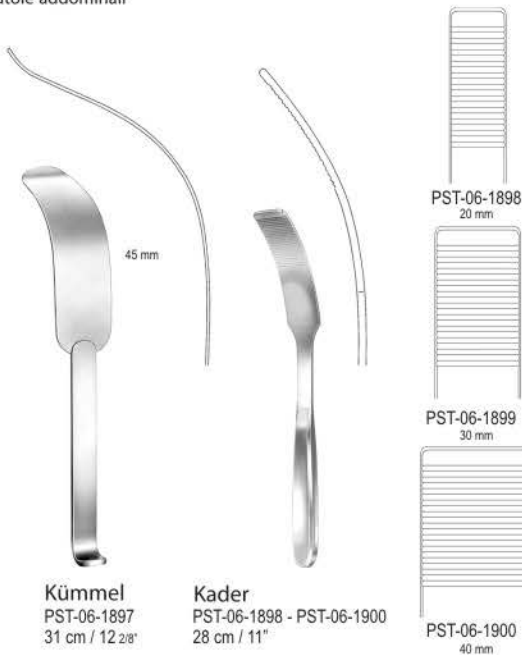

Kümmel
PST-06-1897
31 cm / 12 2/8"

Kader
PST-06-1898 - PST-06-1900
28 cm / 11"

PST-06-1898
20 mm

PST-06-1899
30 mm

PST-06-1900
40 mm

Wundhaken

Retractors
Separadores
Ecarteurs
Divaricatori

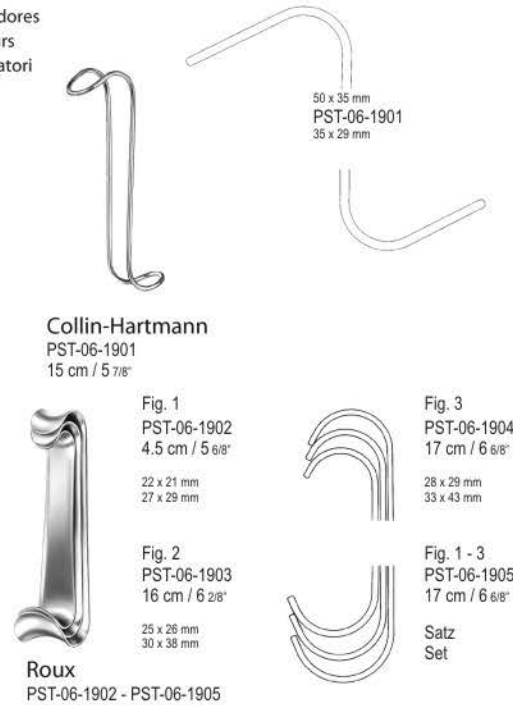

50 x 35 mm
PST-06-1901
35 x 29 mm

Collin-Hartmann
PST-06-1901
15 cm / 5 7/8"

Fig. 1
PST-06-1902
4.5 cm / 5 6/8"

Fig. 2
PST-06-1903
16 cm / 6 2/8"

Fig. 3
PST-06-1904
17 cm / 6 6/8"

Fig. 1 - 3
PST-06-1905
17 cm / 6 6/8"

Roux
PST-06-1902 - PST-06-1905



Wundhaken

Retractors
Separadores
Ecarteurs
Divaricatori

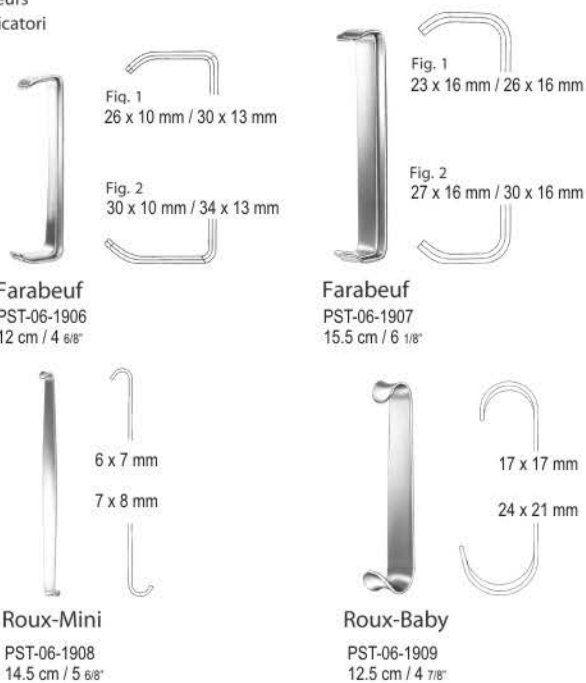

Fig. 1
26 x 10 mm / 30 x 13 mm

Fig. 2
30 x 10 mm / 34 x 13 mm

Farabeuf
PST-06-1906
12 cm / 4 6/8"

Fig. 1
23 x 16 mm / 26 x 16 mm

Fig. 2
27 x 16 mm / 30 x 16 mm

Farabeuf
PST-06-1907
15.5 cm / 6 1/8"

6 x 7 mm

7 x 8 mm

Roux-Mini
PST-06-1908
14.5 cm / 5 6/8"

17 x 17 mm

24 x 21 mm

Roux-Baby
PST-06-1909
12.5 cm / 4 7/8"



Wundhaken

Retractors
Separadores
Ecarteurs
Divaricatori

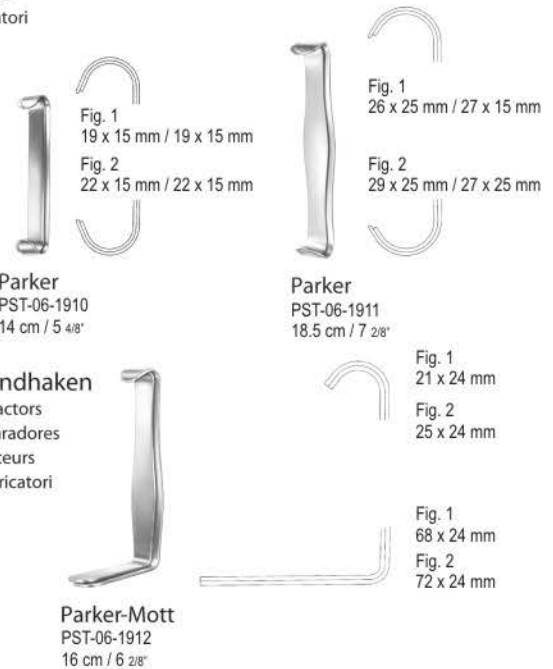

Fig. 1
19 x 15 mm / 19 x 15 mm

Fig. 2
22 x 15 mm / 22 x 15 mm

Parker
PST-06-1910
14 cm / 5 4/8"

Fig. 1
26 x 25 mm / 27 x 15 mm

Fig. 2
29 x 25 mm / 27 x 25 mm

Parker
PST-06-1911
18.5 cm / 7 2/8"

Fig. 1
21 x 24 mm

Fig. 2
25 x 24 mm

Wundhaken
Retractors
Separadores
Ecarteurs
Divaricatori

Parker-Mott
PST-06-1912
16 cm / 6 2/8"

Fig. 1
68 x 24 mm

Fig. 2
72 x 24 mm



Wundhaken

Retractors
Separadores
Ecarteurs
Divaricatori

06



Quality Instruments

Wundhaken

Retractors
Separadores
Ecarteurs
Divaricatori



Goelet
PST-06-1913
19 cm / 7 4/8"



Mathieu
PST-06-1914
20 cm / 7 7/8"



Parker-Langenbeck
PST-06-1915
21.5 cm / 8 4/8"



Wundspreizer

Wound Spreaders, self-retaining
Separadores autoestáticos
Ecarteurs autostatiques
Divaricatori autostatici

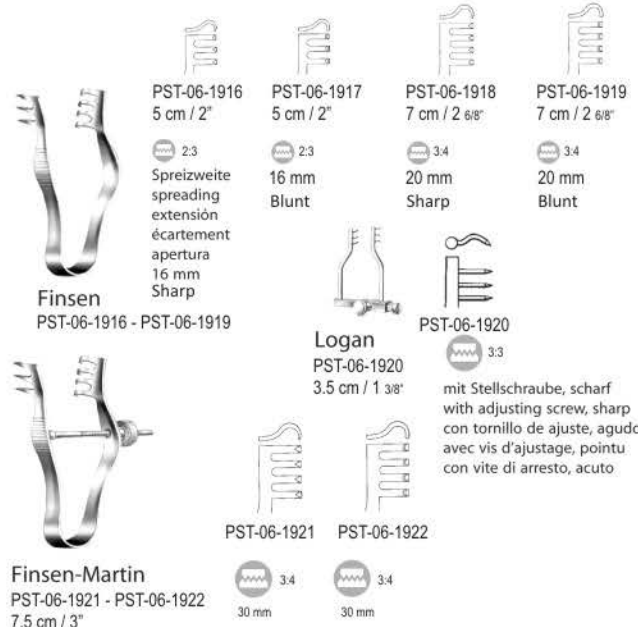

Wundspreizer

Wound Spreaders, self-retaining
Separadores autoestáticos
Ecarteurs autostatiques
Divaricatori autostatici



PST-06-1923
3 cm / 1 1/8"

PST-06-1924
4.5 cm / 1 6/8"

PST-06-1925
6 cm / 2 3/8"

Fettspreizer
für Coronar-Eingriffe
Fat Spreaders
for coronary surgeries
Separadores para grasa
para Cirugia coronaria
Ecarteurs pour graisse
pour intervention coronaire
Divaricatori per grasso
per interventi coronari



Buckley
PST-06-1926
6 cm / 2 3/8"
scharf
sharp
agudo
pointu
acuto



Wundspreizer

Wound Spreaders, self-retaining
Separadores autoestáticos
Ecarteurs autostatiques
Divaricatori autostatici

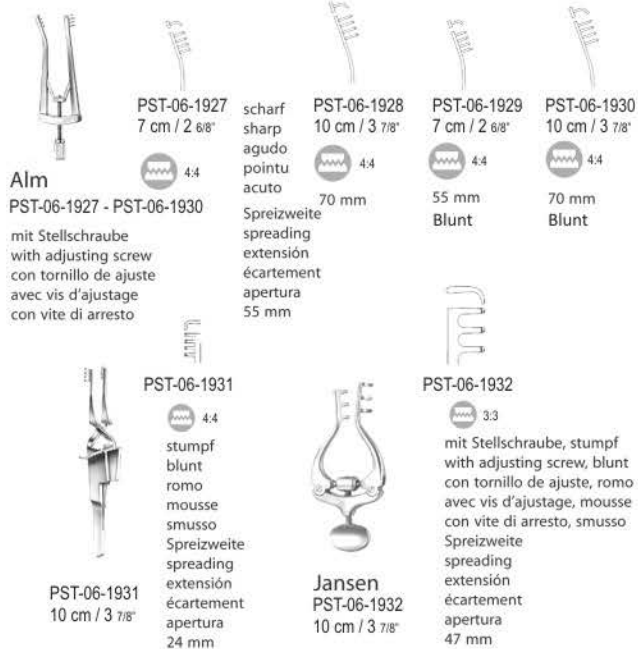

Alm
PST-06-1927 - PST-06-1930
mit Stellschraube
with adjusting screw
con tornillo de ajuste
avec vis d'ajustage
con vite di arresto

PST-06-1931
10 cm / 3 7/8"

Jansen
PST-06-1932
10 cm / 3 7/8"

PST-06-1932
mit Stellschraube, stumpf
with adjusting screw, blunt
con tornillo de ajuste, romo
avec vis d'ajustage, mousse
con vite di arresto, smusso
Spreizweite
spreading
extensión
écartement
apertura
47 mm



Wundhaken
Retractors
Separadores
Ecarteurs
Divaricatori

06



Quality Instruments

Wundspreizer

Wound Spreaders, self-retaining
Separadores autoestáticos
Ecarteurs autostatiques
Divaricatori autostatici



PST-06-1933
13.5 cm / 5 3/8"



PST-06-1934
13.5 cm / 5 3/8"



PST-06-1935
19 cm / 7 4/8"



3:4
scharf
sharp
agudo
pointu
acuto
Spreizweite
spreading
extensión
écartement
apertura
55 mm

3:4
stumpf
blunt
romo
mousse
smusso
Spreizweite
spreading
extensión
écartement
apertura
55 mm



4:4
scharf
sharp
agudo
pointu
acuto
Spreizweite
spreading
extensión
écartement
apertura
84 mm

Scalp-Contour

PST-06-1933 - PST-06-1934
13.5 cm / 5 3/8"

Anderson-Adson

PST-06-1935
19 cm / 7 4/8"



Wundspreizer

Wound Spreaders, self-retaining
Separadores autoestáticos
Ecarteurs autostatiques
Divaricatori autostatici



Travers
PST-06-1936
21.5 cm / 8 4/8"

stumpf
blunt
romo
mousse
smusso
Spreizweite
spreading
extensión
écartement
apertura
95 mm



Norfolk-Norwich
PST-06-1937
22 cm / 8 5/8"

stumpf
blunt
romo
mousse
smusso
Spreizweite
spreading
extensión
écartement
apertura
110 mm



Wundspreizer

Wound Spreaders, self-retaining
Separadores autoestáticos
Ecarteurs autostatiques
Divaricatori autostatici



Weitlaner
PST-06-1938 - PST-06-1939
20 cm / 7 7/8"

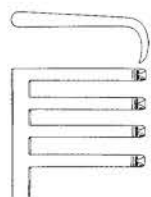

PST-06-1938
20 cm / 7 7/8"

3:4
scharf
sharp
agudo
pointu
acuto
Spreizweite
spreading
extensión
écartement
apertura
90 mm

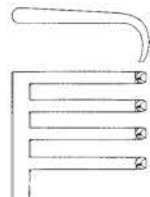

PST-06-1939
20 cm / 7 7/8"

3:4
stumpf
blunt
romo
mousse
smusso
Spreizweite
spreading
extensión
écartement
apertura
90 mm



Wundspreizer

Wound Spreaders, self-retaining
Separadores autoestáticos
Ecarteurs autostatiques
Divaricatori autostatici



Adson
PST-06-1940 - PST-06-1943



PST-06-1940
26 cm / 10 2/8"

3:4
100 mm



PST-06-1942
29 cm / 11 3/8"

6:6
scharf
sharp
agudo
pointu
acuto
Spreizweite
spreading
extensión
écartement
apertura
110 mm



PST-06-1941
26 cm / 10 2/8"

3:4
100 mm



PST-06-1943
29 cm / 11 3/8"

6:6
stumpf
blunt
romo
mousse
smusso
Spreizweite
spreading
extensión
écartement
apertura
110 mm



Wundhaken
Retractors
Separadores
Ecarteurs
Divaricatori

06



Quality Instruments

Wundspreizer

Wound Spreaders, self-retaining
 Separadores autoestáticos
 Ecarteurs autostatiques
 Divaricatori autostatici



Weitlaner
 PST-06-1944 - PST-06-1945
 11 cm / 4 3/8"



PST-06-1944
 11 cm / 4 3/8"
 2.3
 scharf Spreizweite
 sharp spreading
 agudo extensión
 pointu écartement
 acuto apertura
 40 mm



PST-06-1945
 11 cm / 4 3/8"
 2.3
 40 mm
 Blunt



Weitlaner
 PST-06-1946 - PST-06-1949
 13.5 cm / 5 3/8"



PST-06-1946
 13.5 cm / 5 3/8"
 3.4
 scharf Spreizweite
 sharp spreading
 agudo extensión
 pointu écartement
 acuto apertura
 43 mm



PST-06-1947
 16 cm / 6 2/8"
 3.4
 Sharp
 83 mm



PST-06-1948
 13.5 cm / 5 3/8"
 3.4
 Blunt
 43 mm



PST-06-1949
 16 cm / 6 2/8"
 3.4
 Blunt
 83 mm

Wundspreizer

Wound Spreaders, self-retaining
 Separadores autoestáticos
 Ecarteurs autostatiques
 Divaricatori autostatici



Weitlaner-Wullstein
 PST-06-1950 - PST-06-1951
 13 cm / 5 1/8"



PST-06-1950
 3.3
 scharf Spreizweite
 sharp spreading
 agudo extensión
 pointu écartement
 acuto apertura
 40 mm



PST-06-1951
 3.3
 40 mm
 Blunt



PST-06-1952
 4.4
 scharf
 sharp
 agudo
 pointu
 acuto
 Spreizweite
 spreading
 extensión
 écartement
 apertura
 80 mm



Mollison
 PST-06-1952
 15.5 cm / 6 1/8"

Wundspreizer

Wound Spreaders, self-retaining
 Separadores autoestáticos
 Ecarteurs autostatiques
 Divaricatori autostatici



Plester
 PST-06-1953 - PST-06-1954
 13 cm / 5 1/8"



PST-06-1953
 2.2
 stumpf Spreizweite
 blunt spreading
 romo extensión
 mousse écartement
 37 mm



PST-06-1954
 2.2
 Sharp
 37 mm



Plester
 PST-06-1955
 10.5 cm / 4 1/8"



PST-06-1955
 37 mm
 Blunt

Wundspreizer

Wound Spreaders, self-retaining
 Separadores autoestáticos
 Ecarteurs autostatiques
 Divaricatori autostatici



Plester
 PST-06-1956
 10.5 cm / 4 1/8"



PST-06-1956
 stumpf
 blunt
 romo
 mousse
 smusso
 Spreizweite
 spreading
 extensión
 écartement
 apertura
 37 mm



Milligan
 PST-06-1957
 13.5 cm / 5 5/8"



PST-06-1957
 3.3
 stumpf
 blunt
 romo
 mousse
 smusso
 Spreizweite
 spreading
 extensión
 écartement
 apertura
 40 mm



Weitlaner-Baby
 PST-06-1958
 13.5 cm / 5 3/8"

Spreizweite
 spreading
 extensión
 écartement
 apertura
 50 mm

PST-06-1958

Wundspreizer, Mittelvalven

Wound Spreaders, self-retaining
 Separadores autoestáticos
 Ecarteurs autostatiques
 Divaricatori autostatici



Henley
 PST-06-1959
 16.5 cm / 6 4/8"



PST-06-1959
 16.5 cm / 6 4/8"
 3.4
 stumpf
 blunt
 romo
 mousse
 smusso
 Spreizweite
 spreading
 extensión
 écartement
 apertura
 85 mm



PST-06-1960
 16.5 cm / 6 4/8"
 3.4
 scharf
 sharp
 agudo
 pointu
 acuto
 Spreizweite
 spreading
 extensión
 écartement
 apertura
 85 mm

komplett mit 3 Mittelvalven
 Art.-Nr. PST-06-1961 - 62-A und 63-B
 complete with 3 central blades
 ref. PST-06-1961 - 62- 63
 completo con 3 valvas centrales
 ref. PST-06-1961 - 62- 63
 complet avec 3 valves centrales
 réf. PST-06-1961 - 62- 63
 completo con 3 valve centrali
 rif. PST-06-1961 - 62- 63



PST-06-1961
 19 x 17 mm



PST-06-1962
 25 x 17 mm



PST-06-1963
 32 x 17 mm

Wundhaken
Retractors
Separadores
Ecarteurs
Divaricatori

06



Quality Instruments

Wundspreizer

Wound Spreaders, self-retaining
Separadores autoestáticos
Ecarteurs autostatiques
Divaricatori autostatici

Adson
PST-06-1964 - 1971

14 cm / 5 4/8" 16.5 cm / 6 4/8" 21 cm / 8 2/8" 24.5 cm / 9 5/8"

3.4 3.4 3.4 3.4

scharf
sharp
agudo
pointu
acuto

14 cm / 5 4/8" 16.5 cm / 6 4/8" 21 cm / 8 2/8" 24.5 cm / 9 5/8"

3.4 3.4 3.4 3.4

stumpf
blunt
romo
mousse
smusso

Wundspreizer, Valven

Wound Spreaders, self-retaining
Separadores autoestáticos
Ecarteurs autostatiques
Divaricatori autostatici

Cloward
PST-06-1972

4 cm / 1 5/8" 4.5 cm / 1 6/8"

gezahn, Paar
toothed, pair
dentado, par
dentelé, paire
dentato, paio

5.5 cm / 2 1/8"

5 cm / 2"

6 cm / 2 3/8"

komplett mit je 2 Steckvalven
Art.-Nr. PST-06-1972 - PST-06-1976

with 2 each plug-in blades
ref. PST-06-1972 - PST-06-1976

con 2 valvas enchufables de c.u.
ref. PST-06-1972 - PST-06-1976

PST-06-1977
25 cm / 9 7/8"
Sperrer allein
Spreader only
Separador suelto
Ecarteur seul
Divaricatore solo

Wundspreizer, Valven

Wound Spreaders, self-retaining
Separadores autoestáticos
Ecarteurs autostatiques
Divaricatori autostatici

Cloward
PST-06-1978

4 cm / 1 5/8" 4.5 cm / 1 6/8"

glatt, Paar
smooth, pair
lisa, par
lisse, paire
liscio, paio

5.5 cm / 2 1/8"

5 cm / 2"

6 cm / 2 3/8"

komplett mit je 2 Steckvalven
Art.-Nr. PST-06-1978 - PST-06-1982

with 2 each plug-in blades
ref. PST-06-1978 - PST-06-1982

con 2 valvas enchufables de c.u.
ref. PST-06-1978 - PST-06-1982

PST-06-1983
15 cm / 5 7/8"
Sperrer allein
Spreader only
Separador suelto
Ecarteur seul
Divaricatore solo

Wundspreizer

Wound Spreaders, self-retaining
Separadores autoestáticos
Ecarteurs autostatiques
Divaricatori autostatici

Beckmann
PST-06-1984

32 cm / 12 5/8"

scharf
sharp
agudo
pointu
acuto

Adson
PST-06-1985

33 cm / 13"

stumpf
blunt
romo
mousse
smusso



Wundhaken
Retractors
Separadores
Ecarteurs
Divaricatori

06



Quality Instruments

Wundspreizer

Wound Spreaders, self-retaining
Separadores autoestáticos
Ecarteurs autostatiques
Divaricatori autostatici



Beckman-Adson
PST-06-1986 - PST-06-1987



PST-06-1986-A
31 cm / 12 2/8"

stumpf
blunt
romo
mousse
smusso



4:4



PST-06-1987-B
31 cm / 12 2/8"

scharf
sharp
agudo
pointu
acuto



4:4

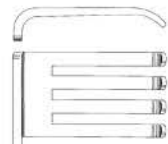

4:4

PST-06-1986-A
30.5 cm / 12"

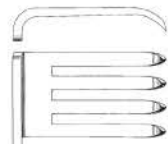

4:4

PST-06-1987-B
30.5 cm / 12"

Wundspreizer

Wound Spreaders, self-retaining
Separadores autoestáticos
Ecarteurs autostatiques
Divaricatori autostatici

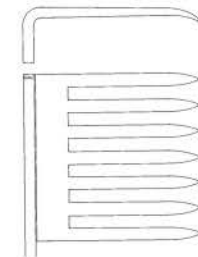

7:7

Beckman-Eaton

PST-06-1988
32 cm / 12 5/8"

scharf
sharp
agudo
pointu
acuto

Wundspreizer

Wound Spreaders, self-retaining
Separadores autoestáticos
Ecarteurs autostatiques
Divaricatori autostatici



Martin
PST-06-1989 - PST-06-1990

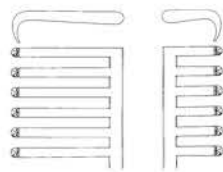

6:6

PST-06-1989
28.5 cm / 11 2/8"

scharf, lange Zähne links
sharp, long teeth on left side
agudo, garfios largos a la izquierda
pointu, griffes longues à gauche
acuto, denti lunghe a sinistra

Spreizweite
spreading
extensión
écartement
apertura
145 mm

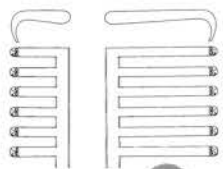

6:6

PST-06-1990
28.5 cm / 11 2/8"

Wundspreizer

Wound Spreaders, self-retaining
Separadores autoestáticos
Ecarteurs autostatiques
Divaricatori autostatici



Joll

PST-06-1991
15.5 cm / 6 1/8"

Thyreoid- und Vulva-Spreizer
Thyroid and Vaginal retractor
Separador para tiroides y vagina
Ecarteur pour thyroïde et vulva
Divaricatore per tiroide e vagina



Gelpi

PST-06-1992
13 cm / 5 1/8"

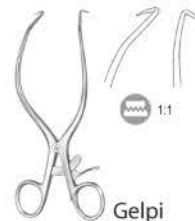

1:1

Gelpi

PST-06-1993
18 cm / 7 1/8"



1:1

Gelpi

PST-06-1994
18.5 cm / 7 2/8"

Wundhaken
Retractors
Separadores
Ecarteurs
Divaricatori

06



Quality Instruments

Wundspreizer

Wound Spreaders, self-retaining
 Separadores autoestáticos
 Ecarteurs autostatiques
 Divaricatori autostatici



Collin, Baby
 PST-06-1995
 20 cm / 7 7/8"

Spreizweite
 spreading
 extensión
 écartement
 apertura
 80 mm



Collin
 PST-06-1996
 20 cm / 7 7/8"
 80 mm

komplett, mit 2 Paar Seitenvalven Art.-Nr. PST-06-1999 (18 x 40 mm) und 06-2002-C (27 x 40 mm)
 complete, with 2 pairs of lateral blades ref. PST-06-1999 (18 x 40 mm) and 06-2002-C (27 x 40 mm)
 completo, con 2 pares de valvas laterales ref. PST-06-1999 (18 x 40 mm) y 06-2002-C (27 x 40 mm)
 complet, avec 2 paires de valves latérales réf. 06-1999 (18 x 40 mm) et 06-2002-C (27 x 40 mm)
 completo, con 2 paia di valve laterali ref. PST-06-1999 (18 x 40 mm) e 06-2002-C (27 x 40 mm)

Bauchdeckenhalter

Abdominal Retractors
 Separadores abdominales
 Ecarteurs abdominaux
 Divaricatori addominali



PST-06-1997A
 Mittelvalve
 central blad
 valva central
 valve centrale
 valva centrale

Collin
 PST-06-1997
 22.5 cm / 8 7/8"

Spreizweite
 spreading
 extensión
 écartement
 apertura
 85 mm

komplett, mit 1 Paar Seitenvalven Art.-Nr. 06-2000 (38 x 60 mm) und Mittelvalve Art.-Nr. 06-1997A (38 x 55 mm)
 complete, with 1 pair of lateral blades ref. 06-2000 (38 x 60 mm) and central blade ref. 06-1997A (38 x 55 mm)
 completo, con 1 par de valvas laterales ref. 06-2000 (38 x 60 mm) y valva central ref. 06-1997A (38 x 55 mm)
 complet, avec 1 paire de valves latérales réf. 06-2000 (38 x 60 mm) et valve centrale réf. 06-1997A (38 x 55 mm)
 completo, con 1 paio di valva laterali rif. 06-2000 (38 x 60 mm) e valva centrale rif. 06-1997A (38 x 55 mm)



Bauchdeckenhalter

Abdominal Retractors
 Separadores abdominales
 Ecarteurs abdominaux
 Divaricatori addominali



Ricard
 PST-06-1998

Sperrer, allein
 Spreader, only
 Bastidor, suelto
 Ecarteur, seule
 Divaricatore, solo



PST-06-1998-A
 Mittelvalve
 Central Blade
 Valva central
 Valva central
 Valva centrale
 Stück
 piece
 pieza
 pièce
 pezzo
 55 x 70 mm

PST-06-1998-B
 Mittelvalve
 Central Blade
 Valva central
 Valva central
 Valva centrale
 Stück
 piece
 pieza
 pièce
 pezzo
 80 x 90 mm

Ricard

komplett mit 1 Paar Seitenvalven Art.-Nr. 06-2006 und Mittelvalve Art.-Nr. 06-1998A
 complete with 1 pair of lateral blades ref. 06-2006 and central blade ref. 06-1998A
 completo con 1 par de valvas laterales ref. 06-2006 y valva central ref. 06-1998A
 complet avec 1 paire de valves latérales ref. 06-2006 et valve centrale ref. 06-1998A
 completo con 1 paio di valve laterali rif. 06-2006 e valva centrale rif. 06-1998A



Seitenvalven

Lateral Blades
 Valvas laterales
 Valves laterales
 Valve laterali



PST-06-1999 - PST-06-2004

PST-06-1999
 18 x 40 mm



PST-06-2002
 27 x 40 mm



PST-06-2000
 38 x 60 mm



PST-06-2003
 40 x 80 mm



PST-06-2001
 45 x 80 mm



PST-06-2004
 60 x 80 mm



Wundhaken Retractors
Separadores
Ecarteurs
Divaricatori

06



Quality Instruments

Seitenvalven

Lateral Blades
Valvas laterales
Valves laterales
Valve laterali



PST-06-2005 - PST-06-2008A

PST-06-2006
50 x 70 mm



PST-06-2006A
50 x 58 mm



PST-06-2007
52 x 110 mm



PST-06-2007A
60 x 80 mm



PST-06-2008
70 x 55 mm



PST-06-2008A
72 x 55 mm



Bauchdeckenhalter

Abdominal Retractors
Separadores abdominales
Ecarteurs abdominaux
Divaricatori addominali



PST-06-2009A
Mittelvalve
central blad
valva central
valve centrale
valva centrale
60 x 56 mm

Gosset
PST-06-2009
16.5 cm / 6 4/8"

Seitenvalven 63 x 35 mm,
1 Mittelvalve 60 x 56 mm
lateral blades 63 x 35 mm,
1 central blade 60 x 56 mm
valvas laterales 63 x 35 mm,
1 valva central 60 x 56 mm
valves latérales 63 x 35 mm,
1 valve centrale 60 x 56 mm
valve laterali 63 x 35 mm,
1 valva centrale 60 x 56 mm

Spreizweite
spreading
extensión
écartement
apertura
160 mm

Gosset-Baby
PST-06-2010
12.5 cm / 4 7/8"

Seitenvalven
lateral blades
valvas laterales
valves latérales
valve laterali
40 x 30 mm
Spreizweite
spreading
extensión
écartement
apertura
120 mm

Bauchdeckenhalter

Abdominal Retractors
Separadores abdominales
Ecarteurs abdominaux
Divaricatori addominali

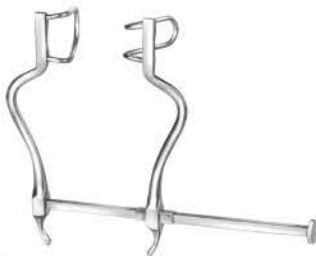

Seitenvalven
lateral blades
valvas laterales
valves latérales
valve laterali
63 x 35 mm
Spreizweite
spreading
extensión
écartement
apertura
140 mm

Gosset
PST-06-2011
18.5 cm / 7 2/8"



PST-06-2013
12.5 cm / 4 7/8"
Mittelvalve
central blade
valva central
valve centrale
vlava centrale
24 x 20 mm

Spreizweite
spreading
extensión
écartement
apertura
95 mm
24 x 20 mm

Balfour-Baby
PST-06-2012 - PST-06-2013
12.5 cm / 4 7/8"

Bauchdeckenhalter

Abdominal Retractors
Separadores abdominales
Ecarteurs abdominaux
Divaricatori addominali

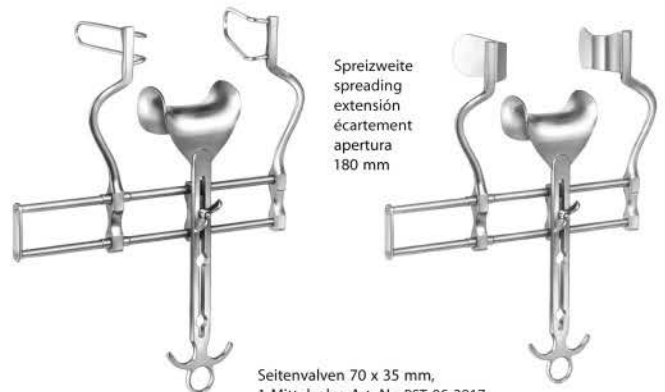

Spreizweite
spreading
extensión
écartement
apertura
180 mm

Balfour
PST-06-2014
20 cm / 7 7/8"

Seitenvalven 70 x 35 mm,
1 Mittelvalve Art.-Nr. PST-06-2017

lateral blades 70 x 35 mm,
1 central blade ref. PST-06-2017
valvas laterales 70 x 35 mm,
1 valva central ref. PST-06-2017
valves latérales 70 x 35 mm,
1 valve centrale réf. PST-06-2017
valve laterali 70 x 35 mm,
1 valva centrale rif. PST-06-2017

Balfour
PST-06-2015
20 cm / 7 7/8"

Wundhaken
Retractors
Separadores
Ecarteurs
Divaricatori

06



Quality Instruments

Bauchdeckenhalter, Mittelvalven

Abdominal Retractors
Separadores abdominales
Ecarteurs abdominaux
Divaricatori addominali



Balfour-Standard
PST-06-2018
20 cm / 7 7/8"
Seitenvalven 100 x 35 mm,
1 Mittelvalve Art.-Nr.06-2017
lateral blades 100 x 35 mm,
1 central blade ref. 06-2017
valvas laterales 100 x 35 mm,
1 valva central ref. 06-2017
valves latérales 100 x 35 mm,
1 valve centrale réf.06-2017
valve laterali 100 x 35 mm,
1 valva centrale rif.06-2017



Balfour
PST-06-2016
20 cm / 7 7/8"

Spreizweite
spreading
extensión
écartement
apertura
200 mm

PST-06-2017
Mittelvalve
central blad
valva central
valve centrale
valva centrale
250 mm

Seitenvalven 100 x 35 mm,
1 Mittelvalve Art.-Nr. 06-2016 (100 x 60 mm)
lateral blades 100 x 35 mm,
1 central blade ref. 06-2016 (100 x 60 mm)
valvas laterales 100 x 35 mm,
1 valva central ref. 06-2016 (100 x 60 mm)
valves latérales 100 x 35 mm,
1 valve centrale réf.06-2016 (100 x 60 mm)
valve laterali 100 x 35 mm,
1 valva centrale rif.06-2016 (100 x 60 mm)



Balfour
PST-06-2019 - PST-06-2021

PST-06-2019
45 x 80 mm
PST-06-2020
68 x 85 mm
PST-06-2021
40 x 68 mm

Bauchdeckenhalter

Abdominal Retractors
Separadores abdominales
Ecarteurs abdominaux
Divaricatori addominali



Balfour, Mod. USA
PST-06-2022
20 cm / 7 7/8"

mit je 1 Paar Seitenvalven Art.-Nr. 06-2024
und PST-06-2025 und 1 Mittelvalve Art.-Nr. 06-2019
with 1 pair each of lateral blades ref. 06-2024
and PST-06-2025 and 1 central blade ref. 06-2019

con 1 par de valvas laterales ref. 06-2024
y PST-06-2025 y 1 valva central ref. 06-2019

avec 1 paire de valves latérales réf. 06-2024
et PST-06-2025 et valve centrale réf. 06-2019

con 1 paio di valve laterale rif. 06-2024
e PST-06-2025 e valve ventrale rif. 06-2019

PST-06-2023
20 cm / 7 7/8"
Spreizweite
spreading
extensión
écartement
apertura
190 mm



PST-06-2024
6 cm / 2 3/8"



PST-06-2025
8 cm / 3 1/8"



Bauchdeckenhalter

Abdominal Retractors
Separadores abdominales
Ecarteurs abdominaux
Divaricatori addominali



O'Sullivan-O'Connor
PST-06-2026 - PST-06-2027

mit 2 festen Seitenvalven, 1 Valve 110 x 70 mm und 2 Valven 80 x 45 mm
Art.-Nr. 06-2026 und 06-2027
with 2 fixed lateral blades, 1 blade 110 x 70 mm and 2 blades 80 x 45 mm
ref. 06-2026 und 06-2027
con 2 vlavas laterales fijas, 1 valva 110 x 70 mm, y 2 valvas 80 x 45 mm
ref. 06-2026 und 06-2027
avec 2 valves latérales fixes, 1 valve 110 x 70 mm, et 2 vlaves 80 x 45 mm
réf. 06-2026 und 06-2027
con 2 valve laterali fisse, 1 valva 110 x 70 mm, e 2 valve 80 x 45 mm
rif. 06-2026 und 06-2027

PST-06-2026 80 x 45 mm
Mittelvalve
central blad
valva central
valve centrale
valva centrale

PST-06-2027 110 x 70 mm



Bauchdeckenhalter

Abdominal Retractors
Separadores abdominales
Ecarteurs abdominaux
Divaricatori addominali



PST-06-2028 40 x 55 mm Standard
PST-06-2029 50 x 65 mm Standard
PST-06-2030 60 x 85 mm Standard
PST-06-2031 78 x 65 mm
PST-06-2032 80 x 90 mm
PST-06-2033 98 x 58 mm
PST-06-2034 105 x 35 mm



Kirschner
PST-06-2028 - PST-06-2034
Rahmen Art.-Nr. 06-2035 3 Haken
Art.-Nr. 06-2030 und je 1 Haken
Art.-Nr. 06-2032 -98 und -99
frame ref. 06-2030 3 hooks
ref. 06-2030 and 1 hook each
ref. 06-2030 -98 and -99
bastidor ref. 06-2030 3 ganchos
ref. 06-2030 y 1 valva c.u.
ref. 06-2030 -98 y -99

für adipöse Patienten
for obese patients
para pacientes obesos
pour patients corpulents
per pazienti obesi

für Darm und Blase
for intestine and bladder
para intestino y vejiga
pour intestin et vessie
per intestino e vesiccia

Kirschner
PST-06-2035
Rahmen, allein
Frame, only
Cuadro, solo
Cadre, seul
Telaio, solo
340 x 240 mm



**Sonden
Watteträger
Spatel**

Probes, Applicators, Spatulas
Sondas, Porta-algodones, Espátulas
Sondes, Porte-Cotons, Spatules
Sonde, Portacotoni, Spatole



Quality Instruments

Knopfsonden

Probes
Sondas abotonadas
Sondes boutonées
Sonde a bottone

PST-07-2101 11 cm / 4 3/8" 2.0 mm
PST-07-2102 13 cm / 5 1/8" 2.0 mm
PST-07-2103 14.5 cm / 5 6/8" 2.0 mm
PST-07-2104 16 cm / 6 2/8" 2.0 mm
PST-07-2105 18 cm / 7 1/8" 2.0 mm
PST-07-2106 20 cm / 7 7/8" 2.0 mm
PST-07-2107 25 cm / 9 7/8" 2.0 mm
PST-07-2108 30 cm / 11 7/8" 2.0 mm

PST-07-2109 11.5 cm / 4 4/8" 1.0 mm
PST-07-2110 13 cm / 5 1/8" 1.0 mm
PST-07-2111 14.5 cm / 5 6/8" 1.0 mm
PST-07-2112 16 cm / 6 2/8" 1.0 mm
PST-07-2113 18 cm / 7 1/8" 1.0 mm
PST-07-2114 20 cm / 7 7/8" 1.0 mm

PST-07-2115 13 cm / 5 1/8" 1.5 mm
PST-07-2116 14.5 cm / 5 6/8" 1.5 mm
PST-07-2117 16 cm / 6 2/8" 1.5 mm
PST-07-2118 18 cm / 7 1/8" 1.5 mm
PST-07-2119 20 cm / 7 7/8" 1.5 mm
PST-07-2120 25 cm / 9 7/8" 1.5 mm

PST-07-2121 13 cm / 5 1/8" 2.0 mm
PST-07-2122 14.5 cm / 5 6/8" 2.0 mm
PST-07-2123 16 cm / 6 2/8" 2.0 mm

Stacke
Ø 1 mm
PST-07-2124

PST-07-2125 13 cm / 5 1/8" 2.0 mm
PST-07-2126 14.5 cm / 5 6/8" 2.0 mm
PST-07-2127 16 cm / 6 2/8" 2.0 mm
PST-07-2128 18 cm / 7 1/8" 2.0 mm
PST-07-2129 20 cm / 7 7/8" 2.0 mm

PST-07-2101 - 2108 PST-07-2109 - 2114 PST-07-2115 - PST-07-2120

PST-07-2121 - 2123 PST-07-2125 - PST-07-2129

Hohlsonden, Fistelsonden

Grooved Directors, Fistula Probes
Sondas acanaladas, Sondas para fistula
Sondes cannelées, Sondes pour fistule
Sonde cannellate, Sonde per fistole

PST-07-2130 13 cm / 5 1/8" PST-07-2133 13 cm / 5 1/8"
PST-07-2131 14.5 cm / 5 6/8" PST-07-2134 14.5 cm / 5 6/8"
PST-07-2132 16 cm / 6 2/8" PST-07-2135 16 cm / 6 2/8"

PST-07-2130 - 2132 PST-07-2133 - 2135

Doyen
PST-07-2136 14.5 cm / 5 6/8"

Nelaton
PST-07-2137 16 cm / 6 2/8"

Lockhart-Mummery
PST-07-2140 16.5 cm / 6 4/8"

Lockhart-Mummery
PST-07-2138 16.5 cm / 6 4/8"

Lockhart-Mummery
PST-07-2139 16.5 cm / 6 4/8"

Lockhart-Mummery
PST-07-2141 16.5 cm / 6 4/8"

Varizeninstrumente

Varix Instruments
Instrumentos para varices
Instruments pour varices
Strumenti per varici

PST-07-2142 18 cm / 7 1/8" PST-07-2143 18 cm / 7 1/8" PST-07-2144 18 cm / 7 1/8" PST-07-2145 17 cm / 6 5/8"

Phlebodissektor
Phlebodissector
Flebodisecador
Dissecteur pour phlébite
Flebo-dissettore

Mini-Phlebextraktor
Mini Phlebextractor
Mini Flebextractor
Extracteur pour phlébite mini
Mini-estrattore per flebiti

Varady
PST-07-2142 - PST-07-2145

Ringstripper

Ring Strippers
Fleboextractores
Strippers à anneau
Stripper anello

PST-07-2146 50 cm / 19 5/8" Ø 2.0 mm PST-07-2147 50 cm / 19 5/8" Ø 3.0 mm PST-07-2148 50 cm / 19 5/8" Ø 4.0 mm

PST-07-2149 50 cm / 19 5/8" Ø 6.0 mm PST-07-2150 50 cm / 19 5/8" Ø 7.0 mm PST-07-2151 50 cm / 19 5/8" Ø 8.0 mm

PST-07-2152 50 cm / 19 5/8" Ø 10mm PST-07-2153 50 cm / 19 5/8" Ø 12 mm PST-07-2154 50 cm / 19 5/8" Ø 14 mm

Vollmar
PST-07-2146 - PST-07-2154

PST-07-2155 11.5 cm / 4 4/8"

Handgriff für Ringstripper nach Vollmar
Handle for Vollmar Ring Stripper
Mango para Vollmar fleboextractor
Manche pour stripper à anneau selon Vollmar
Manico per stripper anello di Vollmar

Watteträger
Cotton Applicators
Porta algodones
Porte-cotons
Portacotone

PST-07-2156 12 cm / 4 6/8" Ø 0.9 mm
PST-07-2157 14 cm / 5 4/8" Ø 0.9 mm
PST-07-2158 16 cm / 6 2/8" Ø 1.1 mm

Farrell
PST-07-2156 - 2158

Farrell
PST-07-2159 14 cm / 5 4/8" Ø 1.2 mm
PST-07-2160 15 cm / 5 7/8" Ø 1.2 mm
PST-07-2161 16 cm / 6 2/8" Ø 1.2 mm
PST-07-2162 18 cm / 7 1/8" Ø 1.2 mm

3-kant
triangular
triangular
triangulaires
triangolare





Perkussionshämmer

Percussion Hammers
Martillos para reflejos
Marteaux-percuteurs
Martelli percussori



Buck

PST-08-2201
18,5 cm / 7 2/8"

mit Nadel und Pinsel
with needle and brush
con aguja y pincel
avec brosse et aiguille
con ago e penello

Buck

PST-08-2202
19 cm / 7 4/8"

Teleskopstiel
telescope handle
mango telescópico
manche télescopique
manico telescopico

Taylor, Mod. USA

PST-08-2203
20 cm / 7 4/8"

Dejerine

PST-08-2204
21 cm / 8 4/8"

mit Nadel
with needle
con aguja
avec aiguille
con ago

Dejerine
PST-08-2205
Size: 210 mm

Perkussionshämmer

Percussion Hammers
Martillos para reflejos
Marteaux-percuteurs
Martelli percussori



PST-08-2206
RABINER
With Needle
And Brush
Size: 255 mm

PST-08-2207
ALY
190 mm

WARTENBERG
Pinwheel For
Neurological
Examination
185 mm

PST-08-2209
WARTENBERG
Pinwheel For
Neurological
Examination
185 mm

PST-08-2210
TROEMNER
245 mm

PST-08-2211
Potela Hamer
Long white
flexible handle
40cm in length

Stethoskope

Stethoscopes
Estetoscopios
Stéthoscopes
Stetoscopi

Ø 37 mm



Duplex-Baby
PST-08-2212
superleicht
super lightweight
super ligero
extrêmement léger
molto leggero

Ø 47 mm



Anaestophon
PST-08-2213
superleicht
super lightweight
super ligero
extrêmement léger
molto leggero

Stethoskope

Stethoscopes
Estetoscopios
Stéthoscopes
Stetoscopi

Ø 47 mm



Pinard
PST-08-2214
18 cm / 7 1/8"
Holz
wood
madera
bois
legno



Pinard
PST-08-2215
15 cm / 5 7/8"



Duplex
PST-08-2216
superleicht
super lightweight
super ligero
extrêmement léger
molto leggero



Winkelmesser, Schieblehren

Flexometer
 Goniómetro
 Goniomètres
 Goniometro

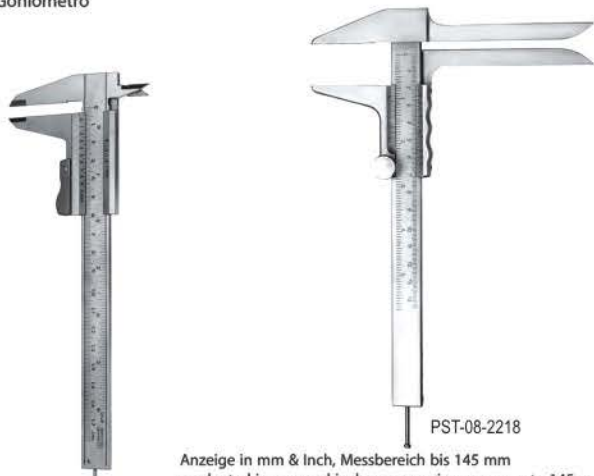

PST-08-2217

Anzeige in mm & Inch, Messbereich bis 145 mm
 graduated in mm and inches, measuring range up to 145 mm
 graduado en mm y pulgadas, alcance de medición hasta 145 mm
 divisé en millimètres et pouces, pour mesurer jusqu'à 145 mm
 diviso in millimetri et pollici, per misurare fino a 145 mm

Anzeige in mm & Inch, Messbereich bis 150 mm
 graduated in mm and inches, measuring range up to 150 mm
 graduado en mm y pulgadas, alcance de medición hasta 150 mm
 divisé en millimètres et pouces, pour mesurer jusqu'à 150 mm
 diviso in millimetri et pollici, per misurare fino a 150 mm

Stirnspiegel

Head Mirrors
 Espejos frontales
 Miroirs frontaux
 Specchio frontale



Ziegler
 PST-08-2219
 Ø 90 mm



Ziegler
 PST-08-2220
 Ø 90 mm

mit Stirnreif 08-2225, ohne Schutzdeckel
 with head band 08-2225, without protection cap
 con cinta frontal 08-2225, sin tapa protectora
 pour bandeau frontal 08-2225, sans couvercle protecteur
 con fascia frontale 08-2225, senza copercchio protettivo



Stirnspiegel

Head Mirrors
 Espejos frontales
 Miroirs frontaux
 Specchio frontale



Ziegler
 PST-08-2221
 Ø 90 mm

Ziegler
 PST-08-2222
 90 mm Ø

mit Stirnreif 08-2226, mit Schutzdeckel
 with head band 08-2226, with protection cap
 con cinta frontal 08-2226, con tapa protectora
 pour bandeau frontal 08-2226, avec couvercle protecteur
 con fascia frontale 08-2226, senza copercchio protettivo



Ziegler
 PST-08-2223
 Ø 90 mm

Ziegler
 PST-08-2224
 90 mm Ø

mit Stirnreif 08-2227, mit Schutzdeckel
 with head band 08-2227, with protection cap
 con cinta frontal 08-2227, con tapa protectora
 pour bandeau frontal 08-2227, avec couvercle protecteur
 con fascia frontale 08-2227, senza copercchio protettivo

Stirnreifen

Head Bands
 Cintas frontales
 Bandeaux frontaux
 Fascia frontale



Martin-Commoda
 PST-08-2225

aus schwarzem Fiber, mit Kugelgelenk
 24 mm breit
 black fiber, with ball joint
 24 mm wide
 de fibra negra, con articulación esférica
 24 mm de ancho
 en celluloid noir, avec articulation sphérique
 largeur 24 mm
 in fibra nera, con articolazione sferica
 larghezza 24 mm



Martin-Commoda
 PST-08-2226

breite Form
 aus weißem Celluloid, mit Kugelgelenk
 broad shape
 white plastic, with ball joint
 forma ancha
 de celuloide blanca, con articulación
 forme large
 en celluloid blanc, avec articulation
 sphérique
 forma larga
 in fibra nera, con articolazione sferica



PST-08-2227
 Martin-Commoda



Gelenkteil für Stirnreifen
 Head Band
 Cinta frontal
 Articulation pour bandeaux frontaux
 Articolazione per fascia frontale





PST-08-2229
 Otoscope Set, Consists Of
 Battery Handle Without Batteries,
 3 Ear Specula, 1 Bulb In
 Velvet Lined Case



PST-08-2230
 Diagnostic Set, Otoscope
 With Three Specula,
 Nasal Speculum, Lamp
 Holder, Two Laryngeal
 Mirrors, Tongue Blade Holder



PST-08-2231 - 2232
 Medium battery handle
 only, 25 mm diam.



PST-08-2231
 Spare bulb
 2.7 volt, for
 Otoscopes etc.



PST-08-2232
 Spare bulb
 2.6 volt, for
 ophthalmoscopes

Stiellupen

Magnifying Glass
 Lupas
 Loupes
 Lenti d'ingrandimento



PST-08-2233
 Ø 50 mm
 bi-konvex
 Metallgriff, Vergrößerung 2,5 x

bi-convex
 metal handle, magnifying power 2,5 x

bi-convex
 mango metálico, aumento 2,5 x

bi-convexe
 à monture en métal, agrandissement 2,5 x

bi-convesso
 manico metallico, ingrandimento 2,5 x



PST-08-2234
 Ø 75 mm
 bi-konvex
 Kunststoffgriff, Vergrößerung 2,5 x

bi-convex
 plastic handle, magnifying power 2,5 x

bi-convex
 mango plástico, aumento 2,5 x

bi-convexe
 à monture en matière plastique,

bi-convesso
 manico in plastica, ingrandimento 2,5 x

Blutdruckmessgeräte

Blood Pressure Manometers
 Manómetros
 Tonomètres
 Sfigmomanometri



PST-08-2235
 Klettenmanschette
 Velcro Cuff
 Brazaletes
 Manchette velcro
 Bracciale velcro



PST-08-2236
 Manometer mit Gummiball
 Manometer with rubber bulb
 Manómetro con pera de goma
 Manomètre avec poire en caoutchouc
 Manometro con pallone in gomma

modello murale
 con bracciale velcro
 tubo a mercurio 300 mm



PST-08-2237
 Wandmodell
 mit Klettenmanschette
 Quecksilberröhre 300 mm
 wall mounted
 with velcro cuff
 mercury tube 300 mm
 modelo de pared
 con brazaletes de velcro
 tubo de mercurio 300 mm
 modèle mural
 avec manchette velcro
 tube à mercure 300 mm

Blutdruckmessgeräte

Blood Pressure Manometers
 Manómetros
 Tonomètres
 Sfigmomanometri



PST-08-2238
 geeicht
 mit Klettenmanschette
 Quecksilberröhre 300 mm
 calibrated
 with velcro cuff
 mercury tube 300 mm
 calibrado
 con brazaletes de velcro
 tubo de mercurio 300 mm
 calibré
 avec manchette velcro
 tube à mercure 300 mm
 calibrato
 con bracciale velcro
 tubo a mercurio 300 mm



PST-08-2239
 geeicht
 mit Klettenmanschette, in Tasche
 mit Manometer
 calibrated
 with velcro cuff, in bag
 with manometer
 calibrado
 con brazaletes de velcro,
 en bolsa
 con manómetro
 calibré
 avec manchette velcro,
 en trousse
 avec manomètre
 calibrato
 con bracciale velcro,
 in borsa
 con manometro

Trokare, Saugar, Kanülen
Trocars, Suction Tubes, Cannulas
Trócares, Tubos de Aspiración, Cánulas
Trocarts, Tubes d'aspiration, Canules
Trequarti, Tubi d'aspirazione, Cannule



09

77 - 79

Narkose
Anaesthesia
Anestesia
Anesthésie
Anestesia



10

80

Naht
Suture
Sutura
Suture
Sutura

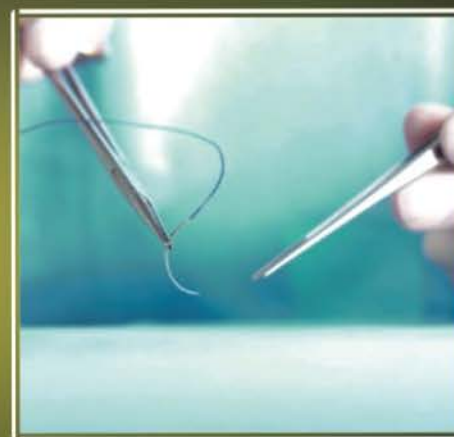

11

81 - 92

Trokare, Saugar,
Kanülen

Trocars, Suction Tubes, Cannulas
Trócares, Tubos de Aspiración, Cánulas
Trocarts, Tubes d'aspiration, Canules
Trequarti, Tubi d'aspirazione, Cannule

09



Quality Instruments

Trokare

Trocars
Trócares
Trocarts
Trequarti



Universal

PST-09-2301
14 cm / 5 4/8"
mit 4 Trokaransätzen
with 4 trocar tips
con 4 puntas de trocar
avec 4 embouts de trocarts
con 4 punte di trequarti
Ø 1,7, 3,0, 4,5 & 6,0 mm

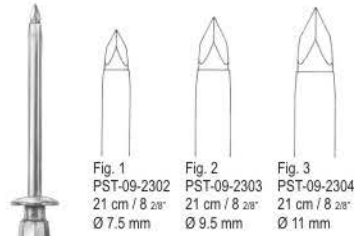

Fig. 1 PST-09-2302 21 cm / 8 2/8" Ø 7.5 mm
Fig. 2 PST-09-2303 21 cm / 8 2/8" Ø 9.5 mm
Fig. 3 PST-09-2304 21 cm / 8 2/8" Ø 11 mm

Nelson

PST-09-2302 - PST-09-2304



Ochsner-Martin

PST-09-2305 - PST-09-2312

PST-09-2305	14 cm / 5 4/8"	Ø 4.0 mm
PST-09-2306	14 cm / 5 4/8"	Ø 4.6 mm
PST-09-2307	14 cm / 5 4/8"	Ø 5.3 mm
PST-09-2308	14 cm / 5 4/8"	Ø 6.0 mm
PST-09-2309	14 cm / 5 4/8"	Ø 6.6 mm
PST-09-2310	14 cm / 5 4/8"	Ø 7.3 mm
PST-09-2311	14 cm / 5 4/8"	Ø 8.0 mm
PST-09-2312	14 cm / 5 4/8"	Ø 8.6 mm



Saugrohre

Suction Cannulas
Tubos de aspiración
Tubes d'aspiration
Tubi d'aspirazione



Adson
PST-09-2323
20 cm / 7 7/8"
Ø 4 mm



Frazier
PST-09-2324
24 cm / 9 4/8"
Ø 3.3 mm



PST-09-2325 - PST-09-2332

PST-09-2325	19.5 cm / 7 5/8"	Ø 2.0 mm
PST-09-2326	19.5 cm / 7 5/8"	Ø 2.3 mm
PST-09-2327	19.5 cm / 7 5/8"	Ø 2.7 mm
PST-09-2328	19.5 cm / 7 5/8"	Ø 3.0 mm
PST-09-2329	19.5 cm / 7 5/8"	Ø 3.3 mm
PST-09-2330	19.5 cm / 7 5/8"	Ø 3.6 mm
PST-09-2331	19.5 cm / 7 5/8"	Ø 4.0 mm
PST-09-2332	19.5 cm / 7 5/8"	Ø 5.0 mm



Saugrohre

Suction Cannulas
Tubos de aspiración
Tubes d'aspiration
Tubi d'aspirazione



PST-09-2313 - PST-09-2317

PST-09-2313	14 cm / 5 4/8"	Ø 1.5 mm
PST-09-2314	14 cm / 5 4/8"	Ø 2.5 mm
PST-09-2315	14 cm / 5 4/8"	Ø 3.0 mm
PST-09-2316	14 cm / 5 4/8"	Ø 4.0 mm
PST-09-2317	14 cm / 5 4/8"	Ø 6.0 mm



PST-09-2318 - PST-09-2322

PST-09-2318	18 cm / 7 1/8"	Ø 1.5 mm
PST-09-2319	18 cm / 7 1/8"	Ø 2.5 mm
PST-09-2320	18 cm / 7 1/8"	Ø 3.0 mm
PST-09-2321	18 cm / 7 1/8"	Ø 4.0 mm
PST-09-2322	18 cm / 7 1/8"	Ø 6.0 mm



Saugrohre

Suction Cannulas
Tubos de aspiración
Tubes d'aspiration
Tubi d'aspirazione



Fergusson

PST-09-2333 - PST-09-2338

PST-09-2333	18 cm / 7 1/8"	Ø 1.5 mm	110 mm
PST-09-2334	18 cm / 7 1/8"	Ø 2.0 mm	110 mm
PST-09-2335	18 cm / 7 1/8"	Ø 2.5 mm	110 mm
PST-09-2336	18 cm / 7 1/8"	Ø 3.0 mm	110 mm
PST-09-2337	18 cm / 7 1/8"	Ø 4.0 mm	110 mm
PST-09-2338	18 cm / 7 1/8"	Ø 5.0 mm	110 mm

Arbeitslänge
working length
largo útil
longueur utile
lunghezza utile



Poppen

PST-09-2339 - PST-09-2342

PST-09-2339	Ø 2.0 mm
PST-09-2340	Ø 2.6 mm
PST-09-2341	Ø 3.3 mm
PST-09-2342	Ø 4.0 mm



Trokare, Saugar,
Kanülen

Trocars, Suction Tubes, Cannulas
Trócares, Tubos de Aspiración, Cánulas
Trocarts, Tubes d'aspiration, Canules
Trequarti, Tubi d'aspirazione, Cannule

09



Quality Instruments

Saugrohre

Suction Tubes
Tubos de aspiración
Tubes d'aspiration
Tubi d'aspirazione



PST-09-2343 16.5 cm / 6 4/8" Ø 3.0 mm
PST-09-2344 16.5 cm / 6 4/8" Ø 3.5 mm
PST-09-2345 16.5 cm / 6 4/8" Ø 4.5 mm

Arbeitslänge
working length
largo útil
longueur utile
lunghezza utile
110 mm

Luer
PST-09-2343
PST-09-2345
konisch
conical
cónico
conique
conico



Yasargil
PST-09-2346 - PST-09-2349

Arbeitslänge
working length
largo útil
longueur utile
lunghezza utile
150 mm

PST-09-2346 17 cm / 6 5/8" Ø 1.5 mm
PST-09-2347 17 cm / 6 5/8" Ø 2.0 mm

PST-09-2348 17 cm / 6 5/8" Ø 2.5 mm
PST-09-2349 17 cm / 6 5/8" Ø 3.5 mm

Sauger

Suction Tubes
Tubos de aspiración
Tubes d'aspiration
Tubi d'aspirazione

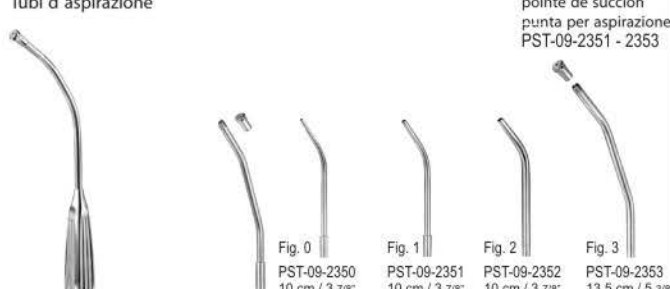

Fig. 0 PST-09-2350 10 cm / 3 7/8"
Fig. 1 PST-09-2351 10 cm / 3 7/8"
Fig. 2 PST-09-2352 10 cm / 3 7/8"
Fig. 3 PST-09-2353 13.5 cm / 5 3/8"

Saugspitze
suction tip
punta de succión
punta per aspirazione
PST-09-2351 - 2353

Yankauer
PST-09-2350
31 cm / 12 2/8"

komplett, mit Saugspitze
und Schlaucholive

complete, with suction tip
and connector
completo, con punta de succión
et raccord
complet, avec pointe de succión
et raccord
completi, con punte d'aspirazione
e raccordo

Yankauer
PST-09-2351 - 2353
31 cm / 12 2/8"
Handgriff

Handle
Mango
Manche
Manico

PST-09-2354
15 cm / 5 7/8"

PST-09-2355
2.5 cm / 1"
Schlaucholive
Olive
Oliva
Olive

Sauger

Suction Tubes
Tubos de aspiración
Tubes d'aspiration
Tubi d'aspirazione



Poole PST-09-2356 24 cm / 9 4/8" Ø 10 mm
Poole PST-09-2357 25 cm / 9 7/8" Ø 8.0 mm
Cooley PST-09-2358 36 cm / 14 1/8" Ø 8.0 mm
Cooley PST-09-2359 31 cm / 12 2/8" Ø 10 mm
Cooley PST-09-2360 31 cm / 12 2/8" Ø 7.0 mm
Cooley PST-09-2361 36 cm / 14 1/8" Ø 8.0 mm

mit perforierter Schraubspitze
with perforated screw tip
con punta perforada y roscada
avec pointe perforée et fileté
con punta perforata e filetta

Sauger

Suction Tubes
Tubos de aspiración
Tubes d'aspiration
Tubi d'aspirazione

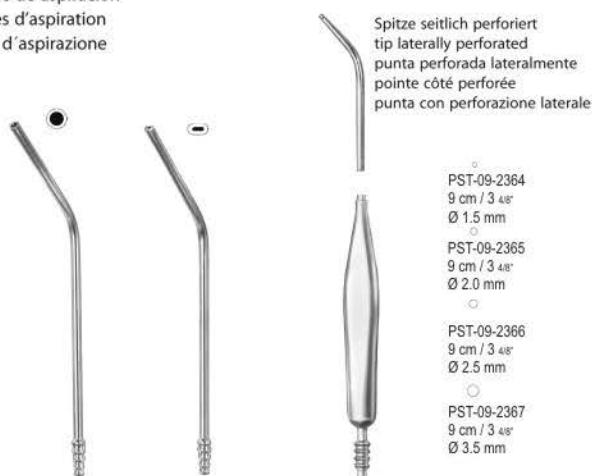

Spitze seitlich perforiert
tip laterally perforated
punta perforada lateralmente
pointe côté perforée
punta con perforazione laterale

PST-09-2364 9 cm / 3 4/8" Ø 1.5 mm
PST-09-2365 9 cm / 3 4/8" Ø 2.0 mm
PST-09-2366 9 cm / 3 4/8" Ø 2.5 mm
PST-09-2367 9 cm / 3 4/8" Ø 3.5 mm

Nuboer
PST-09-2362 21 cm / 8 2/8" Ø 6.0 mm
runde Öffnung
round opening
apertura redonda
ouverture ronde
apertura rotonda

Nuboer
PST-09-2363 21 cm / 8 2/8" Ø 6.0 mm
ovale Öffnung
oval opening
apertura ovalada
ouverture ovale
apertura ovale

Coupland
PST-09-2364 - PST-09-2367
17 cm / 6 5/8"
mit Schlauchansatz
with tube connector
con conexión para tubos
avec connection pour tubes
con raccordo per tubi

Trokare, Saugar,
Kanülen

Trocars, Suction Tubes, Cannulas
Trócares, Tubos de Aspiración, Cánulas
Trocarts, Tubes d'aspiration, Canules
Trequarti, Tubi d'aspirazione, Cannule

09



Quality Instruments

Sauger, Saugrohre

Suction Tubes
Tubos de aspiración
Tubes d'aspiration
Tubi d'aspirazione

Cogswell
PST-09-2371
24.5 cm / 9 5/8"
Ø 3.8 mm
mit Unterbrecher
with finger cut-off
con placa desconectadona
avec plaque interrupteur
con placa interuttore

Byrd
PST-09-2368 - 2370

PST-09-2368
21.5 cm / 8 4/8"
Ø 3.0 mm

PST-09-2369
21.5 cm / 8 4/8"
Ø 3.8 mm

PST-09-2370
21.5 cm / 8 4/8"
Ø 4.3 mm

PST-09-2372 8 cm
PST-09-2373 10 cm
PST-09-2374 12 cm
PST-09-2375 14 cm
PST-09-2376 16 cm

Redon
PST-09-2372 - PST-09-2376
19.5 cm / 7 5/8"

PST-09-2377 8 cm
PST-09-2378 10 cm
PST-09-2379 12 cm
PST-09-2380 14 cm
PST-09-2381 16 cm

Redon
PST-09-2377 - PST-09-2381
19.5 cm / 7 5/8"

Injektionskanülen

Hypodermic Needles
Agujas hipodérmicas
Aiguilles hypodermiques
Cannule per iniezione

Arbeitslänge
working length
largo útil
longueur utile
lunghezza utile



PST-09-2382	Fig. 1	Ø 0.85 mm	40 mm
PST-09-2383	Fig. 2	Ø 0.8 mm	35 mm
PST-09-2384	Fig. 12	Ø 0.7 mm	32 mm
PST-09-2385	Fig. 14	Ø 0.65 mm	30 mm
PST-09-2386	Fig. 16	Ø 0.6 mm	25 mm
PST-09-2387	Fig. 18	Ø 0.5 mm	23 mm
PST-09-2388	Fig. 20	Ø 0.45 mm	18 mm

PST-09-2382 - PST-09-2388

Luer-Lock Ansatz, Packung mit 12 Stück
Luer-Lock connection, package of 12 pieces
conexión Luer-Lock, paquete con 12 piezas
raccord Luer-Lock, untié à 12 pièces
raccordo Luer-Lock, scatola da 12 pezzi



PST-09-2389
Pudendus-Anästhesiekanüle
Pudendus Anaesthesia Needle
Cánula para anestesia transvaginal
Canule pour anesthésie transvaginale
Cannula per anestesia trasvaginale
komplett mit Nadel
complete with needle
completo con aguja
complet avec aiguille
completa con ago

PST-09-2389
18 cm / 7
Luer-Lock Ansatz
Luer Lock connection
100 x 185 mm

Spezialkanülen

Special Needles
Agujas especiales
Aiguilles spéciales
Aghi speciali

Arbeitslänge
working length
largo útil
longueur utile
lunghezza utile

PST-09-2390	Ø 1.2 mm	76 mm
PST-09-2391	Ø 1.2 mm	89 mm
PST-09-2392	Ø 1.0 mm	76 mm
PST-09-2393	Ø 1.0 mm	89 mm
PST-09-2394	Ø 0.7 mm	76 mm
PST-09-2395	Ø 0.7 mm	50 mm
PST-09-2396	Ø 0.7 mm	89 mm

Quinke
PST-09-2390 - PST-09-2396
Lumbalpunktkanüle
Lumbar Puncture Needle
Aguja para punción lumbar
Aiguille pour ponction lombaire
Cannula per puntura lumbale

Tuohy
PST-09-2397

Luer-Lock Ansatz
Luer-Lock connection
conexión Luer-Lock
raccord Luer-Lock
raccordo Luer-Lock

PST-09-2397 Ø 1.2 mm 76 mm
PST-09-2398 Ø 1.4 mm 76 mm
PST-09-2399 Ø 1.6 mm 76 mm

mit Spezialspitze, Luer-Lock Ansatz
with special tip, Luer-Lock connection
con punta especial, conexión Luer-Lock
avec pointe spéciale, raccord Luer-Lock
con punta speciale, raccordo Luer-Lock

Gefäß-Spülkanülen

Vessel Irrigation Cannulas
Cánulas para irrigación vascular
Canules pour irrigation vasculaire
Cannule per irrigazione vascolare

Vollmar
PST-09-2400 - PST-09-2404
6 cm / 2 3/8"

Luer-Lock Ansatz
Luer-Lock connection
conexión Luer-Lock
raccord Luer-Lock
raccordo Luer-Lock

PST-09-2400 Ø 1.5 mm
PST-09-2401 Ø 2.0 mm
PST-09-2402 Ø 2.5 mm
PST-09-2403
PST-09-2404

Schmid
PST-09-2405 - PST-09-2408
6.5 cm / 2 1/2"
Ø 2.9 x 0.8 mm

PST-09-2405
15 cm / 5 7/8"
Ø 3.0 mm

PST-09-2406
15 cm / 5 7/8"
Ø 4.0 mm

PST-09-2407
15 cm / 5 7/8"
Ø 5.0 mm

PST-09-2408
15 cm / 5 7/8"
Ø 6.0 mm

Narkose
Anaesthesia
Anestesia
Anestesia

10



Quality Instruments

Kathetereinführzangen
 Catheter Introducing Forceps
 Pinzas para catéteres
 Pincers pour introduire les sondes
 Pinze per introdurre le sonde



Magill
 PST-10-2501 - PST-10-5203

Laryngoskope und Zubehör
 Laryngoscopes and Accessories
 Laringoscopios y accesorios
 Laryngoscopes et accessoires
 Laringoscopi ed accessori

-  PST-10-2501
15.5 cm / 6 1/8"
für Kleinkinder
for babies
para neonatales
pour nourrissons
per neonati
-  PST-10-2502
17.5 cm / 6 7/8"
für Kinder
for children
para niños
pour enfants
per bambini
-  PST-10-2503
20 cm / 7 7/8"
für Erwachsene
for adults
para adultos
pour adultes
per adulti

Miller
 PST-10-2504
 mit drei Laryngoskopspateln
 Fig. 1 bis 3,
 komplett, in Etui
 with three laryngoscope blades
 fig. 1 to 3,
 complete, in case
 con tres hojas de laringoscopia
 fig. 1 a 3,
 completo, en estuche
 avec trois spatules à laryngoscopia
 fig. 1 à 3,
 complet, en trousse

Miller
 PST-10-2505
 mit vier Laryngoskopspateln
 Fig. 1 bis 4,
 komplett, in Etui
 with four laryngoscope blades
 fig. 1 to 4,
 complete, in case
 con cuatro hojas de laringoscopia
 fig. 1 a 4,
 completo, en estuche



Miller-Baby
 PST-10-2506
 mit zwei Laryngoskopspateln
 Fig. 0 und 1,
 komplett, in Etui
 with two laryngoscope blades
 fig. 0 and 1,

Laryngoskope und Zubehör
 Laryngoscopes and Accessories
 Laringoscopios y accesorios
 Laryngoscopes et accessoires
 Laringoscopi ed accessori

PST-10-2507
 Fig. 0
 für Säuglinge
 for babies
 para neonatales
 pour nourrissons
 per neonati 55 mm



PST-10-2508
 Fig. 1
 für Kinder
 for children
 para niños
 pour enfants
 per bambini
 80 mm



PST-10-2510
 Fig. 4
 für Männer
 for men
 para hombres
 pour hommes
 per uomini 170 mm



PST-10-2511
 Fig. 3
 für Frauen
 for women
 para mujeres
 pour femmes
 per donne
 180 mm







Miller
 PST-10-2507 - PST-10-2511

Laryngoskope und Zubehör
 Laryngoscopes and Accessories
 Laringoscopios y accesorios
 Laryngoscopes et accessoires
 Laringoscopi ed accessori



McIntosh
 PST-10-2512
 mit drei Laryngoskopspateln
 Fig. 1 bis 3,
 komplett, in Etui
 with three laryngoscope blades
 fig. 1 to 3,
 complete, in case
 con tres hojas de laringoscopia
 fig. 1 a 3,
 completo, en estuche
 avec trois spatules à laryngoscopia
 fig. 1 à 3,
 complet, en trousse
 con tre spatole per laringoscopia
 fig. 1,
 completo, in scatola

McIntosh
 PST-10-2513
 mit vier Laryngoskopspateln
 Fig. 1 bis 4,
 komplett, in Etui
 with four laryngoscope blades
 fig. 1 to 4,
 complete, in case
 con cuatro hojas de laringoscopia
 fig. 1 a 4,
 completo, en estuche
 avec quatre spatules à laryngoscopia
 fig. 1 à 4,
 complet, en trousse
 con quattro spatole per laringoscopia
 fig. 1 fino a 4,
 completo, in scatola

-  PST-10-2514
Fig. 0
für babies
55 mm
-  PST-10-2515
Fig. 1
für children
75 mm
-  PST-10-2516
Fig. 2
für adolescents
80 mm
-  PST-10-2517
Fig. 3
für women
110 mm
-  PST-10-2518
Fig. 4
für men
135 mm

PST-10-2514 - 2518

Kaltlicht-Laryngoskope und Zubehör
 Fiber Optic Laryngoscopes and Accessories
 Laringoscopios de luz fría y accesorios
 Laryngoscopes de lumière froide et accessoires
 Laringoscopi di luce fredda ed accessori



Laryngoskopiebestecke
 Kaltlicht
 Laryngoscope Sets
 fiber optic
 Juegos de laringoscopia
 luz fría
 Jeux à laryngoscopia
 lumière froide
 Set per laringoscopia
 luce fredda



Kaltlicht
 fiber optic
 luz fría
 lumière froide
 luce fredda
 pour hommes
 per uomini
 para mujeres
 pour femmes
 per donne

McIntosh
 PST-10-2519
McIntosh
 PST-10-2520
McIntosh
 PST-10-2521
McIntosh
 PST-10-2522
 mit Batteriehandgriff (ohne Batterie)
 und drei Laryngoskopspatel Fig. 1 bis 3
 komplett, in Etui
 with battery handle (without batteries)
 and three laryngoscope blades fig. 1 to 3
 complete, in case
 con mango de pilas (sin pilas)
 y tres hojas de laringoscopia fig. 1 a 3
 completo, en estuche
 avec manche à pile (sans pile)
 et trois spatules à laryngoscopia fig. 1 à 3
 complet, en trousse
 con manico a pila (senza pila)
 e tre spatole per laringoscopia fig. 1 fino a 3
 completo, in scatola

McIntosh
 PST-10-2523 - PST-10-2527

PST-10-2523
 Fig. 0
 für Säuglinge
 for babies
 para neonatales
 pour nourrissons
 per neonati
 Nutzlänge
 working length
 largo útil
 longueur utile
 lunghezza operante
 55 mm

PST-10-2524
 Fig. 1
 für Kinder
 for children
 para niños
 pour enfants
 per bambini
 PST-10-2525
 Fig. 2
 für Jugendliche
 for adolescents
 para adolescentes
 pour adolescents
 per adolescenti
 PST-10-2527
 Fig. 4
 für Männer
 for men
 para hombres

Naht
Suture
Sutura
Suture
Sutura

11



Quality Instruments

Chirurgische Nadeln

Surgical Needles
Agujas quirúrgicas
Aiguilles chirurgicales
Aghi chirurgici

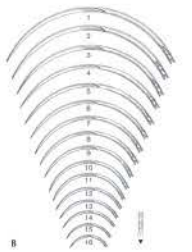

gebogen 3/8 Kreis, VE = 12 Stück
curved, 3/8 circle, SU = 12/pack
curvas 3/8 círculo, UV = 12 piezas
courbes 3/8 cercle, UC = 12 unités
curvi 3/8 círculo, UV = 12 pezzi

- Fig.
- PST-11-2601 1
 - PST-11-2602 2
 - PST-11-2603 3
 - PST-11-2604 4
 - PST-11-2605 5
 - PST-11-2606 6
 - PST-11-2607 7
 - PST-11-2608 8
 - PST-11-2609 9
 - PST-11-2610 10
 - PST-11-2611 11
 - PST-11-2612 12
 - PST-11-2613 13
 - PST-11-2614 14
 - PST-11-2615 15
 - PST-11-2616 16



gebogen 1/2 Kreis, VE = 12 Stück
curved, 1/2 circle, SU = 12/pack
curvas 1/2 círculo, UV = 12 piezas
courbes 1/2 cercle, UC = 12 unités
curvi 1/2 círculo, UV = 12 pezzi

- Fig.
- PST-11-2617 1
 - PST-11-2618 2
 - PST-11-2619 3
 - PST-11-2620 4
 - PST-11-2621 5
 - PST-11-2622 6
 - PST-11-2623 7
 - PST-11-2624 8
 - PST-11-2625 9
 - PST-11-2626 10
 - PST-11-2627 11
 - PST-11-2628 12
 - PST-11-2629 13
 - PST-11-2630 14
 - PST-11-2631 15
 - PST-11-2632 16



gebogen 1/2 Kreis, VE = 12 Stück
curved, 1/2 circle, SU = 12/pack
curvas 1/2 círculo, UV = 12 piezas
courbes 1/2 cercle, UC = 12 unités
curvi 1/2 círculo, UV = 12 pezzi

- Fig.
- PST-11-2633 1
 - PST-11-2634 2
 - PST-11-2635 3
 - PST-11-2636 4
 - PST-11-2637 5
 - PST-11-2638 6
 - PST-11-2639 7
 - PST-11-2640 8
 - PST-11-2641 9
 - PST-11-2642 10
 - PST-11-2643 11
 - PST-11-2644 12
 - PST-11-2645 13
 - PST-11-2646 14
 - PST-11-2647 15
 - PST-11-2648 16



gebogen 1/2 Kreis, VE = 12 Stück
curved, 1/2 circle, SU = 12/pack
curvas 1/2 círculo, UV = 12 piezas
courbes 1/2 cercle, UC = 12 unités
curvi 1/2 círculo, UV = 12 pezzi

- Fig.
- PST-11-2649 1
 - PST-11-2650 2
 - PST-11-2651 3
 - PST-11-2652 4
 - PST-11-2653 5
 - PST-11-2654 6
 - PST-11-2655 7
 - PST-11-2656 8
 - PST-11-2657 9

Chirurgische Nadeln

Surgical Needles
Agujas quirúrgicas
Aiguilles chirurgicales
Aghi chirurgici

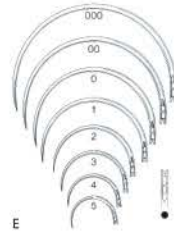

gebogen 1/2 Kreis, VE = 12 Stück
curved, 1/2 circle, SU = 12/pack
curvas 1/2 círculo, UV = 12 piezas
courbes 1/2 cercle, UC = 12 unités
curvi 1/2 círculo, UV = 12 pezzi

- Fig.
- PST-11-2658 1
 - PST-11-2659 2
 - PST-11-2660 3
 - PST-11-2661 4
 - PST-11-2662 5
 - PST-11-2663 6
 - PST-11-2664 7
 - PST-11-2665 8



- Fig.
- PST-11-2672 1
 - PST-11-2673 2
 - PST-11-2674 3
 - PST-11-2675 4
 - PST-11-2676 5
 - PST-11-2677 6



- Fig.
- PST-11-2666 1
 - PST-11-2667 2
 - PST-11-2668 3
 - PST-11-2669 4
 - PST-11-2670 5
 - PST-11-2671 6

Keilh
VE = 12 Stück
SU = 12/pack
UV = 12 piezas
UC = 12 unités
UV = 12 pezzi



Mikro-Nadelhalter

Micro Needle Holders
Micro Porta-agujas
Micro porte-aiguilles
Micro Portaghi



mit Sperre with ratchet con trinquete avec cran d'arrêt con arresto 0.30 mm PST-11-2678 15 cm / 5 7/8	mit Sperre with ratchet con trinquete avec cran d'arrêt con arresto 0.30 mm PST-11-2679 15 cm / 5 7/8	ohne Sperre w/o ratchet sin trinquete sans cran d'arrêt senza arresto 0.30 mm PST-11-2680 15 cm / 5 7/8	ohne Sperre w/o ratchet sin trinquete sans cran d'arrêt senza arresto 0.30 mm PST-11-2681 15 cm / 5 7/8
----------------------------------------------------------------------------------------------------------------------------	----------------------------------------------------------------------------------------------------------------------------	------------------------------------------------------------------------------------------------------------------------------	------------------------------------------------------------------------------------------------------------------------------

PST-11-2678 - PST-11-2681



mit Sperre with ratchet con trinquete avec cran d'arrêt con arresto 0.30 mm PST-11-2682 15 cm / 5 7/8	mit Sperre with ratchet con trinquete avec cran d'arrêt con arresto 0.30 mm PST-11-2683 15 cm / 5 7/8	ohne Sperre w/o ratchet sin trinquete sans cran d'arrêt senza arresto 0.30 mm PST-11-2684 15 cm / 5 7/8	ohne Sperre w/o ratchet sin trinquete sans cran d'arrêt senza arresto 0.30 mm PST-11-2685 15 cm / 5 7/8
----------------------------------------------------------------------------------------------------------------------------	----------------------------------------------------------------------------------------------------------------------------	------------------------------------------------------------------------------------------------------------------------------	------------------------------------------------------------------------------------------------------------------------------

Castroviejo

PST-11-2682 - PST-11-2685



Mikro-Nadelhalter

Micro Needle Holders
Micro Porta-agujas
Micro porte-aiguilles
Micro Portaghi



mit Sperre with ratchet con trinquete avec cran d'arrêt con arresto 0.40 mm PST-11-2686 18 cm / 7 1/8	mit Sperre with ratchet con trinquete avec cran d'arrêt con arresto 0.40 mm PST-11-2687 18 cm / 7 1/8	ohne Sperre w/o ratchet sin trinquete sans cran d'arrêt senza arresto 0.40 mm PST-11-2688 18 cm / 7 1/8	ohne Sperre w/o ratchet sin trinquete sans cran d'arrêt senza arresto 0.40 mm PST-11-2689 18 cm / 7 1/8
----------------------------------------------------------------------------------------------------------------------------	----------------------------------------------------------------------------------------------------------------------------	------------------------------------------------------------------------------------------------------------------------------	------------------------------------------------------------------------------------------------------------------------------

Castroviejo

PST-11-2686 - PST-11-2689

mit Sperre with ratchet con trinquete avec cran d'arrêt con arresto 0.40 mm 15 cm / 5 7/8	mit Sperre with ratchet con trinquete avec cran d'arrêt con arresto 0.40 mm PST-11-2690 15 cm / 5 7/8	mit Sperre with ratchet con trinquete avec cran d'arrêt con arresto 0.40 mm PST-11-2691 15 cm / 5 7/8	ohne Sperre w/o ratchet sin trinquete sans cran d'arrêt senza arresto 0.40 mm PST-11-2692 15 cm / 5 7/8	ohne Sperre w/o ratchet sin trinquete sans cran d'arrêt senza arresto 0.40 mm PST-11-2693 15 cm / 5 7/8	ohne Sperre w/o ratchet sin trinquete sans cran d'arrêt senza arresto 0.40 mm PST-11-2694 15 cm / 5 7/8	ohne Sperre w/o ratchet sin trinquete sans cran d'arrêt senza arresto 0.40 mm PST-11-2695 15 cm / 5 7/8	ohne Sperre w/o ratchet sin trinquete sans cran d'arrêt senza arresto 0.40 mm PST-11-2696 15 cm / 5 7/8	ohne Sperre w/o ratchet sin trinquete sans cran d'arrêt senza arresto 0.40 mm PST-11-2697 15 cm / 5 7/8	ohne Sperre w/o ratchet sin trinquete sans cran d'arrêt senza arresto 0.40 mm PST-11-2698 18 cm / 7 1/8	ohne Sperre w/o ratchet sin trinquete sans cran d'arrêt senza arresto 0.40 mm PST-11-2699 18 cm / 7 1/8	ohne Sperre w/o ratchet sin trinquete sans cran d'arrêt senza arresto 0.40 mm PST-11-2700 18 cm / 7 1/8	ohne Sperre w/o ratchet sin trinquete sans cran d'arrêt senza arresto 0.40 mm PST-11-2701 18 cm / 7 1/8
-------------------------------------------------------------------------------------------------------------	----------------------------------------------------------------------------------------------------------------------------	----------------------------------------------------------------------------------------------------------------------------	------------------------------------------------------------------------------------------------------------------------------	------------------------------------------------------------------------------------------------------------------------------	------------------------------------------------------------------------------------------------------------------------------	------------------------------------------------------------------------------------------------------------------------------	------------------------------------------------------------------------------------------------------------------------------	------------------------------------------------------------------------------------------------------------------------------	------------------------------------------------------------------------------------------------------------------------------	------------------------------------------------------------------------------------------------------------------------------	------------------------------------------------------------------------------------------------------------------------------	------------------------------------------------------------------------------------------------------------------------------

PST-11-2690 - PST-11-2704



Naht
Suture
Sutura
Suture
Sutura

11



Quality Instruments

Mikro-Nadelhalter

Micro Needle Holders
Micro Porta-agujas
Micro porte-aiguilles
Micro Portaghi

	mit Sperre with ratchet con trinquete avec cran d'arrêt con arresto	mit Sperre with ratchet con trinquete avec cran d'arrêt con arresto	ohne Sperre w/o ratchet sin trinquete sans cran d'arrêt senza arresto	ohne Sperre w/o ratchet sin trinquete sans cran d'arrêt senza arresto
Ø 0.08 mm	Ø 0.08 mm	Ø 0.08 mm	Ø 0.08 mm	Ø 0.08 mm
15 cm / 5 7/8"	PST-11-2705	PST-11-2706	PST-11-2707	PST-11-2708
15 cm / 5 7/8"	PST-11-2709	PST-11-2710	PST-11-2711	PST-11-2712
18 cm / 7 1/8"	PST-11-2713	PST-11-2714	PST-11-2715	PST-11-2716
18 cm / 7 1/8"	PST-11-2717	PST-11-2718	PST-11-2719	PST-11-2720
21 cm / 8 2/8"	PST-11-2721	PST-11-2722	PST-11-2723	PST-11-2724
21 cm / 8 2/8"	PST-11-2725	PST-11-2726	PST-11-2727	PST-11-2728
23 cm / 9"	PST-11-2729	PST-11-2730	PST-11-2731	PST-11-2732

Kalt
PST-11-2733
13.5 cm / 5 1/8"

Barraquer-Troutman
PST-11-2734 - PST-11-2735

Arruga
PST-11-2736 - PST-11-2737

Mikro-Nadelhalter

Micro Needle Holders
Micro Porta-agujas
Micro porte-aiguilles
Micro Portaghi

PST-11-2738 10.5 cm / 4 1/8"

PST-11-2739 11.5 cm / 4 4/8"

PST-11-2740 10.5 cm / 4 1/8"

PST-11-2741 11.5 cm / 4 4/8"

Barraquer-Troutman
PST-11-2738 - PST-11-2741

PST-11-2742 11.5 cm / 4 4/8"

PST-11-2743 11.5 cm / 4 4/8"

PST-11-2744 13.5 cm / 5 3/8"

PST-11-2745 14 cm / 5 4/8"

PST-11-2746 14 cm / 5 4/8"

Barraquer
PST-11-2742 - PST-11-2746



Mikro-Nadelhalter

Micro Needle Holders
Micro Porta-agujas
Micro porte-aiguilles
Micro Portaghi

Barraquer
PST-11-2747
13.5 cm / 5 3/8"

Castroviejo-Fino
PST-11-2748
13 cm / 5 1/8"

Castroviejo-Fino
PST-11-2749
13 cm / 5 1/8"

sehr feines Maul, mit Sperre
very delicate jaw, with lock
boca muy delicada, con cierre
mors très fin, avec serrure
morso strafino, con fermo

Castroviejo-Fino
PST-11-2750
14.5 cm / 5 6/8"

Castroviejo-Fino
PST-11-2751
14.5 cm / 5 6/8"

Castroviejo-Fino
PST-11-2752
14.5 cm / 5 6/8"

Castroviejo-Fino
PST-11-2753
14.5 cm / 5 6/8"

Castroviejo-Fino
PST-11-2754
13 cm / 5 1/8"

Castroviejo
PST-11-2750 - PST-11-2751

Castroviejo
PST-11-2752 - PST-11-2753

Mikro-Nadelhalter, Nadelhalter

Micro Needle Holders, Needle Holders
Micro Porta-agujas, Porta-agujas
Micro porte-aiguilles, Porte-aiguilles
Micro Portaghi, Portaghi

Castroviejo
PST-11-2755
14.5 cm / 5 6/8"

Castroviejo
PST-11-2756
14.5 cm / 5 6/8"

Castroviejo
PST-11-2757
14.5 cm / 5 6/8"

Castroviejo
PST-11-2758 - PST-11-2759

Castroviejo
PST-11-2760
12 cm / 4 6/8"

Castroviejo
PST-11-2761
12 cm / 4 6/8"



Naht
Suture
Sutura
Suturie
Sutura

11



Quality Instruments

Nadelhalter

Needle Holders
Porta-agujas
Porte-aiguilles
Portaghi



PST-11-2762
12 cm / 4 5/8"



PST-11-2763
13 cm / 5 1/8"

Derf

PST-11-2762 - PST-11-2763

Collier

PST-11-2764
12.5 cm / 4 7/8"



Webster

PST-11-2765
13 cm / 5 1/8"



Halsey

PST-11-2766
13.5 cm / 5 3/8"



Neivert

PST-11-2767
12.5 cm / 4 7/8"

glattes Maul mit Spezialkehlung
smooth jaw, special groove
boca lisa, especialmente acanalada
mors lisse, avec stries spéciales
morso liscio con scannellatura speciale

Nadelhalter

Needle Holders
Porta-agujas
Porte-aiguilles
Portaghi



Hegar-Baumgartner

PST-11-2768
14 cm / 5 4/8"



Brown

PST-11-2769 - PST-11-2770
13 cm / 5 1/8"

kräftiges Modell
heavy pattern
modelo fuerte
modèle fort
modello forte



Crile-Murray

PST-11-2771
15 cm / 5 7/8"

schlankes Modell
slender pattern
modelo delgado
modèle gracile
modello delicato

Crile-Wood

PST-11-2772
15 cm / 5 7/8"



PST-11-2769
13 cm / 5 1/8"

PST-11-2770
18 cm / 7 1/8"

Maul diagonal gerieft
diagonally serrated jaw
boca estriada transversalmente
mors strié transversalement
con strie diagonali

Nadelhalter

Needle Holders
Porta-agujas
Porte-aiguilles
Portaghi



Adson

PST-11-2773
18.5 cm / 7 2/8"

ein Maulteil gefenestert
one fenestrated jaw
un lado de la boca fenestrada
un côté de mors fenêtré
una parte del morso finestrata



Metzenbaum

PST-11-2774
18.5 cm / 7 2/8"

ein Maulteil gekehlt und gefenestert
one grooved and fenestrated jaw
un lado de la boca acanalado y fenestrado
un côté de mors strié et fenêtré
una parte del morso scannellata e finestrata



M. G. Hospital

PST-11-2775
18 cm / 7 1/8"

kräftiges Modell
heavy pattern
modelo fuerte
modèle fort
modello forte



Mayo-Hegar

PST-11-2776 - PST-11-2782



PST-11-2776
14.5 cm / 5 5/8"



PST-11-2777
16 cm / 6 2/8"



PST-11-2778
18.5 cm / 7 2/8"



PST-11-2779
20.5 cm / 8 1/8"



PST-11-2780
24 cm / 9 4/8"



PST-11-2781
26.5 cm / 10 3/8"



PST-11-2782
30.5 cm / 12"

Nadelhalter

Needle Holders
Porta-agujas
Porte-aiguilles
Portaghi



Mayo-Hegar

PST-11-2783 - PST-11-2774

schlankes Modell
slender pattern
modelo delgado
modèle gracile
modello delicato

PST-11-2783
16 cm / 6 2/8"

PST-11-2784
19 cm / 7 4/8"

PST-11-2785
20.5 cm / 8 1/8"



Heaney

PST-11-2786
20.5 cm / 8 1/8"



Jamison

PST-11-2787
23 cm / 9"

Naht
Suture
Sutura
Suturie
Sutura

11



Quality Instruments

Nadelhalter
Needle Holders
Porta-agujas
Porte-aiguilles
Portaghi



Masson

PST-11-2788
26.5 cm / 10 3/8"
kräftiges Modell
heavy pattern
modelo fuerte
modèle fort
modello forte



Finochietto

PST-11-2789
26.5 cm / 10 3/8"



Nadelhalter
Needle Holders
Porta-agujas
Porte-aiguilles
Portaghi



Stratte

PST-11-2792
23 cm / 9"

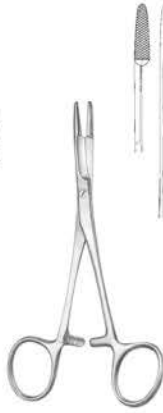

Olsen-Hegar

PST-11-2793
14 cm / 5 4/8"



Gillies

PST-11-2794
16 cm / 6 2/8"



Nadelhalter
Needle Holders
Porta-agujas
Porte-aiguilles
Portaghi



Wangenstein

PST-11-2790
26.5 cm / 10 3/8"



Johnson

PST-11-2791
27 cm / 10 5/8"



Nadelhalter
Needle Holders
Porta-agujas
Porte-aiguilles
Portaghi



Crile

PST-11-2795
15 cm / 5 7/8"



Mathieu

PST-11-2796 - PST-11-2798

PST-11-2796
14 cm / 5 4/8"

PST-11-2797
17 cm / 6 5/8"

PST-11-2798
20 cm / 7 7/8"



PST-11-2799
14 cm / 5 4/8"

PST-11-2800
17 cm / 6 5/8"

Mathieu

PST-11-2799 - PST-11-2800

schlankes Modell
slender pattern
modelo delgado
modèle gracile
modello delicato



Toennis

PST-11-2801
18.5 cm / 7 2/8"



Lichtenberg

PST-11-2802
20 cm / 7 7/8"



Naht
Suture
Sutura
Suturie
Sutura

11



Quality Instruments

Mikro-Nadelhalter

Micro Needle Holders
Micro Porta-agujas
Micro porte-aiguilles
Micro Portaghi

TC GOLD

PST-11-2803
16 cm / 6 2/8"
glattes Maul
smooth jaw
boca lisa
mors lisse
morso liscio

PST-11-2804
23 cm / 9"

PST-11-2805
23 cm / 9"

PST-11-2806
19 cm / 7 4/8"

Hepp-Scheidel
PST-11-2807
18.5 cm / 7 2/8"

Webster
Crile-Wood
PST-11-2808 - 2809

Miniprofil
mini profile
perfil mini
profil mini
profilo mini

Mikro-Nadelhalter

Micro Needle Holders
Micro Porta-agujas
Micro porte-aiguilles
Micro Portaghi

mit Sperre
with ratchet
con trinquete
avec cran d'arrêt
con arresto

ohne Sperre
w/o ratchet
sin trinquete
sans cran d'arrêt
senza arresto

2,0 mm 2,0 mm 2,0 mm 2,0 mm

15 cm / 5 7/8" PST-11-2810 PST-11-2811 PST-11-2812 PST-11-2813
18 cm / 7 1/8" PST-11-2814 PST-11-2815 PST-11-2816 PST-11-2817
21 cm / 8 2/8" PST-11-2818 PST-11-2819 PST-11-2820 PST-11-2821
23 cm / 9" PST-11-2822 PST-11-2823 PST-11-2824 PST-11-2825

PST-11-2810 - PST-11-2825

PST-11-2826
18 cm / 7 2/8"
2.0 mm

PST-11-2827
21 cm / 7 2/8"
2.0 mm

Gregory
PST-11-2826 - PST-11-2827
mit Sperre, doppelt übersetzt
with lock, double-action
con cierre, articulación doble
avec serrure, articulation double
con fermo, articolazione doppia

JABOMA
PST-11-2828
18 cm / 7 1/8"
Mikroprofil
micro profile
perfil micro
profil micro
profilo micro

KLS Martin TC-Gold Nadelhalter mit Hartmetalleinlagen

KLS Martin TC-Gold Needle Holders with tungsten carbide inserts
KLS Martin TC-Gold Porta-agujas con plaquitas de carburo tungsteno
KLS Martin TC-Gold Porte-aiguilles avec inserts en carbure tungstène
KLS Martin TC-Gold Portaghi con morsi in carburo tungsteno

TC GOLD

PST-11-2829

- Hartmetalleinlagen mit präzise gearbeitetem Pyramidenprofil für sicheren Halt der Nadel
- tungsten carbide inserts with precisely performed structure grants a secure grip of needle
- plaquitas de carburo tungsteno con un perfil amoldado en forma de pirámide garantizan un ajuste seguro de la aguja
- les inserts en carbure de tungstène avec structure pyramidale usinée avec précision garantissent un maintien sûr de l'aiguille
- gli inserti di carburo di tungsteno avente struttura piramidale assicurano una presa sicura sull'ago.
- sorgfältig gehärtet für gleichbleibende Elastizität und Stabilität
- thoroughly tempered for constant elasticity and stability
- templado cuidadosamente para garantizar una elasticidad y estabilidad constante
- trempé soigneusement pour garantir une élasticité et stabilité constante
- accuratamente temprato per garantire una elasticità e stabilità costante.



- gebrochene Kanten verhindern das Verfangen des Nahtmaterials
- bevelled edges prevent catching of suture material
- aristas matadas evitan que se enreden los hilos de sutura
- les bords carrés empêchent le matériel de suture de s'embrouiller
- i bordi sono arrotondati per favorire l'annodamento della sutura
- leichtgängige Sperre ermöglicht eine sichere Arbeitsweise
- smoothly working ratchet provides a safe handling
- cierre suave facilita un manejo seguro
- blocage souple permet de travailler de manière sûre
- la cremagliera facilmente manovrabile permette di lavorare in
- sorgfältig gehärtet für gleichbleibende maniera sicura.
- vergoldete Ringe zur leichten Identifizierung
- golden rings for easy identification
- anillos dorados para fácil identificación
- anneaux dorés pour faciliter l'identification
- anelli dorati per una facile identificazione

Mikro-Nadelhalter

Micro Needle Holders
Micro Porta-agujas
Micro porte-aiguilles
Micro Portaghi

TC GOLD

PST-11-2830
14.5 cm / 5 6/8"
Mikroprofil
micro profile

PST-11-2831
14.5 cm / 5 6/8"
Mikroprofil
micro profile

PST-11-2832
14.5 cm / 5 6/8"
glattes Maul
smooth jaw

PST-11-2833
18 cm / 7 1/8"
Mikroprofil
micro profile

PST-11-2834
22 cm / 8 5/8"

PST-11-2835
14.5 cm / 5 6/8"
glattes Maul
smooth jaw
boca lisa
mors lisse
morso liscio

PST-11-2836
18 cm / 7 1/8"
micro profile

PST-11-2837
22 cm / 8 5/8"
micro profile

Castroviejo
PST-11-2830-
PST-11-2837

Arruga
PST-11-2838 - PST-11-2839
16 cm / 6 2/8"

PST-11-2838
Mini Profile

PST-11-2839
Mini Profile



Naht
Suture
Sutura
Sutura
Suture

11



Quality Instruments

Mikro-Nadelhalter

Micro Needle Holders
Micro Porta-agujas
Micro porte-aiguilles
Micro Portaghi

TC GOLD



Castroviejo

PST-11-2840
12.5 cm / 4 7/8"
mit Sperre, glattes Maul
with lock, smooth jaw
con cierre, mors lisse
con fermo, morso liscio



Barraquer

PST-11-2841
13 cm / 5 1/8"



Barraquer

PST-11-2842
13 cm / 5 1/8"



Webster

PST-11-2843
13 cm / 5 1/8"



Kilner

PST-11-2844
14.5 cm / 5 6/8"



Derf

PST-11-2845
12 cm / 4 6/8"



Nadelhalter

Needle Holders
Porta-agujas
Porte-aiguilles
Portaghi

TC GOLD



Hegar-Baumgartner

PST-11-2846 - PST-11-2847

PST-11-2846
13 cm / 5 1/8"

PST-11-2847
14.5 cm / 5 6/8"

PST-11-2848
13 cm / 5 1/8"

PST-11-2849
13 cm / 5 1/8"



Halsey

PST-11-2848 - PST-11-2849



Webster

PST-11-2850
12 cm / 4 6/8"



Crile-Wood

PST-11-2851
15 cm / 5 7/8"



Crile-Wood

PST-11-2852
20 cm / 7 7/8"



Nadelhalter

Needle Holders
Porta-agujas
Porte-aiguilles
Portaghi

TC GOLD



Sarot

PST-11-2853 - PST-11-2855

Normalprofil
standard profile
perfil estándar
profil normal
profilo normale

PST-11-2853
18 cm / 7 1/8"

PST-11-2854
20 cm / 7 7/8"

PST-11-2855
26 cm / 10 2/8"

PST-11-2856
16 cm / 6 2/8"

PST-11-2857
20 cm / 7 7/8"

PST-11-2858
20 cm / 7 7/8"

PST-11-2859
24 cm / 9 4/8"

PST-11-2860
26 cm / 10 2/8"

PST-11-2861
30 cm / 11 6/8"



Mayo-Hegar

PST-11-2856 - 2861

Normalprofil
standard profile
perfil estándar
profil normal
profilo normale



Nadelhalter

Needle Holders
Porta-agujas
Porte-aiguilles
Portaghi

TC GOLD



Heaney

PST-11-2862
PST-11-2864

PST-11-2862
20.5 cm / 8 1/8"

PST-11-2863
24 cm / 9 4/8"

PST-11-2864
26.5 cm / 10 3/8"

PST-11-2865
18 cm / 7 6/8"

PST-11-2866
20 cm / 7 2/8"

PST-11-2867
23 cm / 9"

PST-11-2868
26 cm / 10 7/8"

PST-11-2869
31 cm / 12 1/8"



De Bakey

PST-11-2865 - PST-11-2869

schlankes Modell, Miniprofil
slender pattern, mini profile
modelo delgado, perfil mini
modèle gracileprofil mini
modello delicato, profilo mini



Masson

PST-11-2870
26.5 cm / 10 3/8"

Normalprofil
standard profile
perfil estándar
profil normal
profilo normale



Naht
Suture
Sutura
Sutura
Suture

11



Quality Instruments

Nadelhalter

Needle Holders
Porta-agujas
Porte-aiguilles
Portaghi

TC **GOLD**



Ryder

PST-11-2871 - PST-11-2876

Normalprofil
standard profile
perfil estándar
profil normal
profilo normale



Martin

PST-11-2877 - PST-11-2879
15 cm / 5 7/8"

Miniprofil, elastisches Modell
mini profile, elastic tip
perfil min, modelo elástico
profil mini, modèle souple
profilo mini, modello molle

Nadelhalter

Needle Holders
Porta-agujas
Porte-aiguilles
Portaghi

TC **GOLD**



Finochietto

PST-11-2880
27 cm / 10 5/8"

Normalprofil
standard profile
perfil estándar
profil normal
profilo normale



Ryder-Vascular

PST-11-2881 - PST-11-2886

Mikroprofil, schlankes Modell
micro profile, delicate pattern
perfil micro, modelo delgado
profil micro, modèle gracile
profilo micro, modello gracile

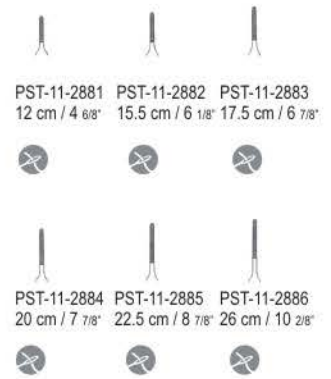

Nadelhalter

Needle Holders
Porta-agujas
Porte-aiguilles
Portaghi

TC **GOLD**



Wangenstein

PST-11-2887
27 cm / 10 5/8"
Normalprofil
standard profile
perfil estándar
profil normal
profilo normale

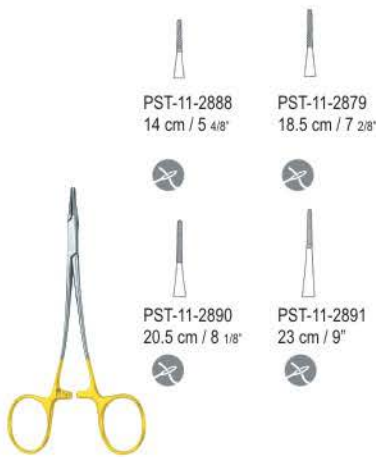

Hegar-Vascular

PST-11-2888 - PST-11-2891

Mikroprofil
micro profile
perfil micro
profil micro
profilo micro

Nadelhalter

Needle Holders
Porta-agujas
Porte-aiguilles
Portaghi

TC **GOLD**



Bozeman

PST-11-2892 - PST-11-2895

Normalprofil
standard profile
perfil estándar
profil normal
profilo normale



Hegar

PST-11-2896 - PST-11-2897

Normalprofil
standard profile
perfil estándar
profil normal
profilo normale



Naht Suture
Sutura

11



Quality Instruments

Nadelhalter

Needle Holders
Porta-agujas
Porte-aiguilles
Portaghi

TC GOLD

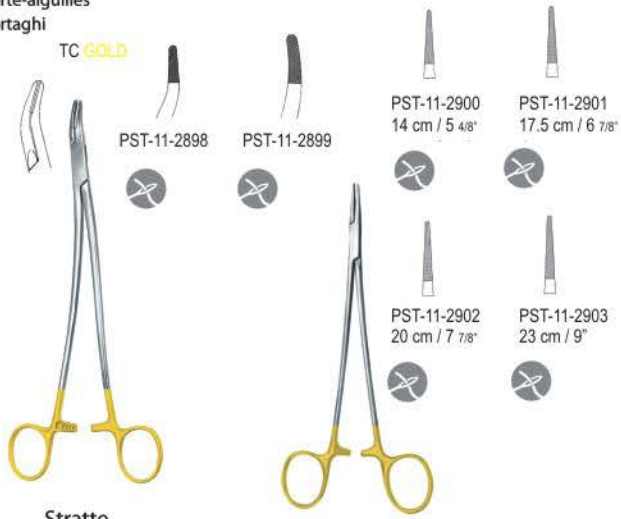

Stratte

PST-11-2898 - PST-11-2899
23 cm / 9"

Normalprofil
standard profile
perfil estándar
profil normal
profilo normale

Microvascular

PST-11-2900 - PST-11-2903

Mikroprofil, schlankes Modell
micro profile, delicate pattern
perfil micro, modelo delgado
profil micro, modèle gracile
profilo micro, modelo gracile

PST-11-2900
14 cm / 5 4/8"

PST-11-2901
17.5 cm / 6 7/8"

PST-11-2902
20 cm / 7 7/8"

PST-11-2903
23 cm / 9"



Nadelhalter

Needle Holders
Porta-agujas
Porte-aiguilles
Portaghi

TC GOLD

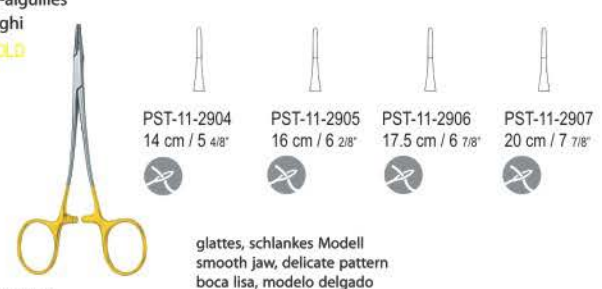

Martini

PST-11-2904 - PST-11-2896

PST-11-2904
14 cm / 5 4/8"

PST-11-2905
16 cm / 6 2/8"

PST-11-2906
17.5 cm / 6 7/8"

PST-11-2907
20 cm / 7 7/8"

glattes, schlankes Modell
smooth jaw, delicate pattern
boca lisa, modelo delgado
mors lisse, modèle gracile
morso liscio, modelo gracile



Martini

PST-11-2908 - PST-11-2911

PST-11-2908
14 cm / 5 4/8"

PST-11-2909
15 cm / 5 7/8"

PST-11-2910
17.5 cm / 6 7/8"

PST-11-2911
20 cm / 7 7/8"

Mikroprofil, schlankes Modell
micro profile, delicate pattern
perfil micro, modelo delgado
profil micro, modèle gracile
profilo micro, modelo gracile



Nadelhalter

Needle Holders
Porta-agujas
Porte-aiguilles
Portaghi

TC GOLD

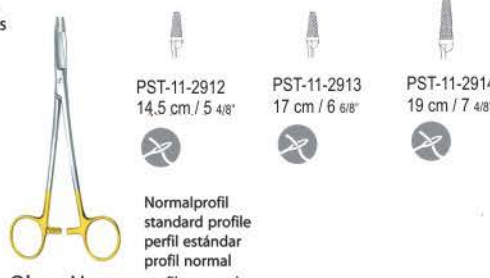

Olsen Hegar

PST-11-2912 - PST-11-2914

Normalprofil
standard profile
perfil estándar
profil normal
profilo normale

PST-11-2912
14.5 cm / 5 4/8"

PST-11-2913
17 cm / 6 6/8"

PST-11-2914
19 cm / 7 4/8"



Foster-Gillies

PST-11-2915
11 cm / 4 3/8"
glattes Maul
smooth jaw
boca lisa
mors lisse
morso liscio



Gillies-Mini

PST-11-2916
15 cm / 5 7/8"
Miniprofil
mini profile
perfil mini
profil mini
profilo mini



Gillies

PST-11-2917
16 cm / 6 2/8"
Normalprofil
standard profile
perfil estándar
profil normal
profilo normale



Nadelhalter

Needle Holders
Porta-agujas
Porte-aiguilles
Portaghi

TC GOLD



Mathieu

PST-11-2918 - PST-11-2920

PST-11-2918
14 cm / 5 4/8"

PST-11-2919
17 cm / 6 6/8"

PST-11-2920
20 cm / 7 7/8"

Normalprofil
standard profile
perfil estándar
profil normal
profilo normale



Mathieu

PST-11-2921 - PST-11-2923

PST-11-2921
14 cm / 5 4/8"

PST-11-2922
17 cm / 6 6/8"

PST-11-2923
20 cm / 7 7/8"

Normalprofil
standard profile
perfil estándar
profil normal
profilo normale



Naht
Suture
Sutura
Suturie
Sutura

11



Quality Instruments

Nadelhalter

Needle Holders
Porta-agujas
Porte-aiguilles
Portaghi

TC GOLD

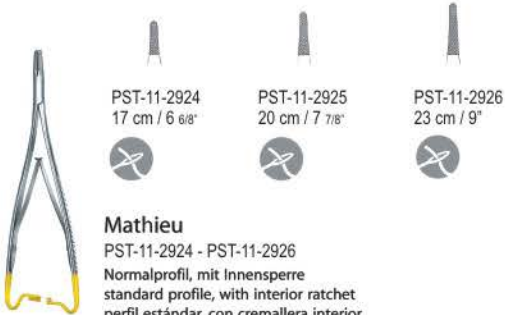

Mathieu

PST-11-2924 - PST-11-2926
Normalprofil, mit Innensperre
standard profile, with interior ratchet
perfil estándar, con cremallera interior
profil normal, avec crémaillère interne
profilo normale, con cremagliera interna



Toennis

PST-11-2927
17 cm / 6 6/8"
Normalprofil
standard profile
perfil estándar
profil normal
profilo normale



Lichtenberg

PST-11-2928
20 cm / 7 7/8"
Normalprofil
standard profile
perfil estándar
profil normal
profilo normale

Nadelhalter

Needle Holders
Porta-agujas
Porte-aiguilles
Portaghi

TC GOLD



Langenbeck

PST-11-2929 - PST-11-2931
Normalprofil
standard profile
perfil estándar
profil normal
profilo normale

Zweifel

PST-11-2932 - PST-11-2933
mit Klappsperre, Normalprofil
with hinged ratchet, standard profile
con cremallera abatible, perfil estándar
avec crémaillère repliable, profil normal
con cremagliera a scatto, profilo normale



Reverdin Nadeln

Reverdin Needles
Agujas de Reverdin
Aguilles de Reverdin
Aghi di Reverdin

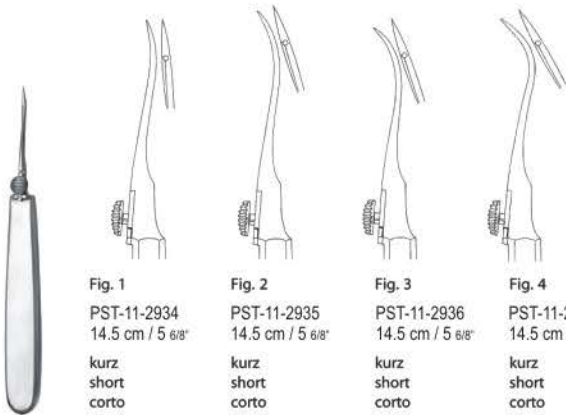

Fig. 1

PST-11-2934
14.5 cm / 5 6/8"
kurz
short
corto
court
corto

Fig. 2

PST-11-2935
14.5 cm / 5 6/8"
kurz
short
corto
court
corto

Fig. 3

PST-11-2936
14.5 cm / 5 6/8"
kurz
short
corto
court
corto

Fig. 4

PST-11-2937
14.5 cm / 5 6/8"
kurz
short
corto
court
corto

Reverdin

PST-11-2934 - PST-11-2937



Reverdin Nadeln

Reverdin Needles
Agujas de Reverdin
Aguilles de Reverdin
Aghi di Reverdin

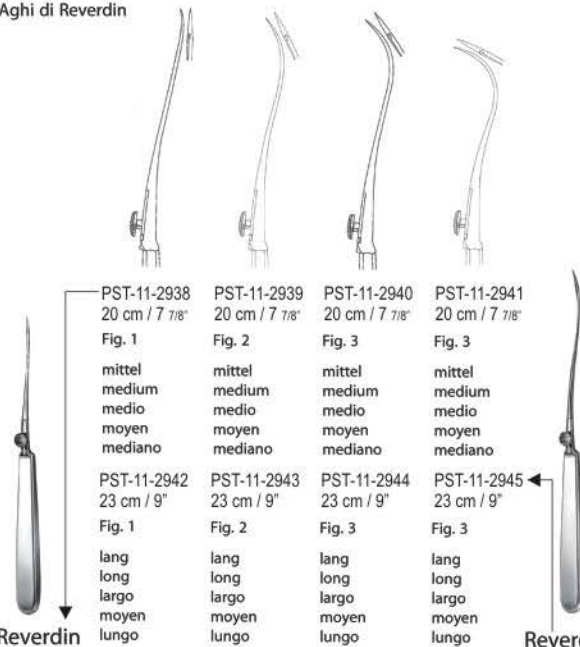

PST-11-2938
20 cm / 7 7/8"
Fig. 1

mittel
medium
medio
moyen
mediano

lang
long
largo
moyen
lungo

PST-11-2939
20 cm / 7 7/8"
Fig. 2

mittel
medium
medio
moyen
mediano

lang
long
largo
moyen
lungo

PST-11-2940
20 cm / 7 7/8"
Fig. 3

mittel
medium
medio
moyen
mediano

lang
long
largo
moyen
lungo

PST-11-2941
20 cm / 7 7/8"
Fig. 3

mittel
medium
medio
moyen
mediano

lang
long
largo
moyen
lungo

Reverdin

PST-11-2938 - PST-11-2941

Reverdin

PST-11-2942 - 2945



Naht
Suture
Sutura
Sutura
Suture

11



Quality Instruments

Nadelhalter, Unterbindungsnadeln

Needle Holder, Ligature Needles
Porta-agujas, Agujas para ligaduras
Porte-aiguilles, Aiguilles à ligatures
Portaghi, Aghi per legatura

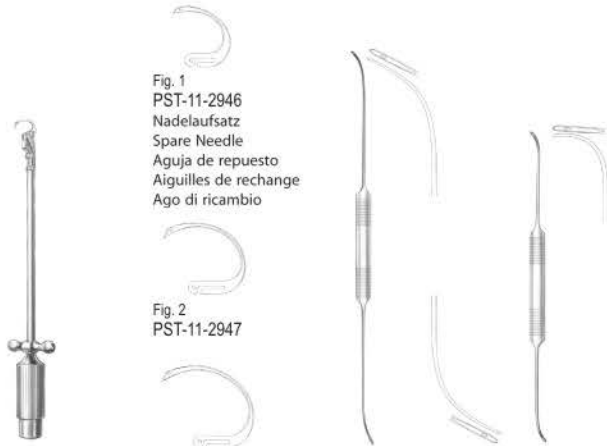

Fig. 1
PST-11-2946
Nadelaufsatz
Spare Needle
Aguja de repuesto
Aiguilles de rechange
Ago di ricambio

Fig. 2
PST-11-2947

Fig. 3
PST-11-2948

Young
PST-11-2946 - 2948
24.5 cm / 9 3/4"

komplett, mit einem Nadelaufsatz Fig. 1
complete, with one needle no. 1
completo, con una aguja no. 1
complet, avec une aiguille fig. 1
completo, con un ago fig. 1

Schmieden-Dick

PST-11-2949
30 cm / 11 6/8"
biegsam
malleable
maleable
malleabile

Schmieden

PST-11-2950
24cm / 9 4/8"

Unterbindungsnadeln

Ligature Needles
Agujas para ligaduras
Aiguilles à ligatures
Aghi per legatura



PST-11-2951
20 cm / 7 7/8"
biegsam
malleable
maleable
malleabili

Cooper
PST-11-2952
20 cm / 7 7/8"

Kronecker
PST-11-2953
12 cm / 4 6/8"
fein, für die rechte Hand
delicate, for right hand
fina, para la mano derecha
fine, pour la main droite
fino, per la mano destra

Kronecker
PST-11-2954
12 cm / 4 6/8"
fein, für die linke Hand
delicate, for left hand
fina, para la mano izquierda
fine, pour la main gauche
fino, per la mano sinistra



Unterbindungsnadeln

Ligature Needles
Agujas para ligaduras
Aiguilles à ligatures
Aghi per legatura

All Sizes are available



Deschamps
PST-11-2955
24 cm / 9 4/8"

stumpf, für die rechte Hand
blunt, for right hand
roma para la mano derecha
mousse, pour la main droite
smusso, per la mano destra

Deschamps
PST-11-2956
24 cm / 9 4/8"

Left Hand

Deschamps
PST-11-2957
20 cm / 7 4/8"

Right Hand

Deschamps
PST-11-2958
20 cm / 7 7/8"

stumpf, für die linke Hand
blunt, for left hand
roma para la mano izquierda
mousse, pour la main gauche
smusso, per la mano sinistra



Unterbindungsnadeln

Ligature Needles
Agujas para ligaduras
Aiguilles à ligatures
Aghi per legatura

All Sizes are available



Deschamps
PST-11-2959
20 cm / 7 7/8"

scharf, für die rechte Hand
sharp, for right hand
aguda para la mano derecha
aiguë, pour la main droite
acuto, per la mano destra

Deschamps
PST-11-2960
20 cm / 7 7/8"

Left Hand

Deschamps
PST-11-2961
20 cm / 7 7/8"

Right Hand

Deschamps
PST-11-2962
20 cm / 7 7/8"

stumpf, für die linke Hand
blunt, for left hand
roma para la mano izquierda
mousse, pour la main gauche
smusso, per la mano sinistra



Naht
Suture
Sutura
Suturie
Sutura

11



Quality Instruments

Führungshohlsonden

Ligature Conductors
Sondas conductoras
Sondes conductrices
Sonde conduttrici



Kirschner
PST-11-2963
25.5 cm / 10"

PST-11-2964
28 cm / 11"

Mod. Martin
PST-11-2965
19.5 cm / 7 5/8"

Führungshohlsonden, Fadenfänger

Ligature Conductors
Sondas conductoras
Sondes conductrices
Sonde conduttrici

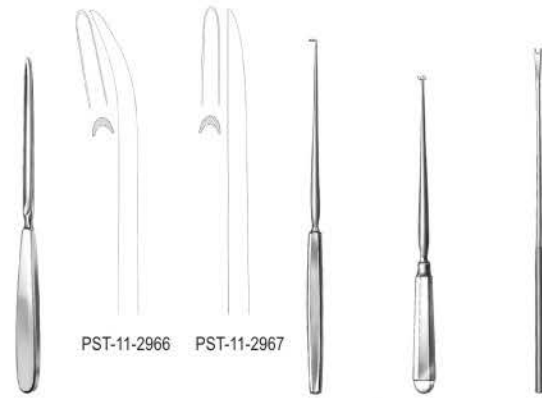

Payr
PST-11-2966 - PST-11-2967
22 cm / 8 5/8"

Modell Wien
PST-11-2968
23.5 cm / 9 2/8"

Bozemann
PST-11-2969
22 cm / 8 5/8"

PST-11-2970
23 cm / 9"

Fadenfänger
Ligature Catcher
Captador de hilos
Porte-ligature
Portalegature

Schlingendreher
Knot Tier
Tuerce-lazos
Tords-fil
Torcifilo

Fadengabel
Ligature Adjuster
Horquilla de hilos
Pousse-fil
Forchetta da sutura



Wundklammerpinzetten, Wundklammerzängchen

Clip Applying Forceps
Pinzas aplicadoras para agrafes
Pincas à poser les agrafes
Pinze per applicare le agrafe



Wundrandpinzette
Approximation Forceps
Pinza aproximadora
Pincas à poser les agrafes
Pinza per i margini della ferita
kräftig, mit Klammerschiene
heavy pattern, with clip holder
modelo fuerte, con barra para
modèle fort, avec porte-agrafe
modello forte, con portaagrafes



Childe
PST-11-2971
17 cm / 6 5/8"

Michel
PST-11-2972
12 cm / 4 5/8"

Hegenbarth
PST-11-2973
12 cm / 4 5/8"

Wachenfeldt
PST-11-2974
12 cm / 4 5/8"



Michel
PST-11-2975
12.5 cm / 4 7/8"

Michel
PST-11-2976
13 cm / 4"



Richter
PST-11-2977
14 cm / 5 4/8"

zum Anlegen und Abnehmen von Klammern
for applying and removal of clips
para aplicar y quitar agrafes
pour appliquer et enlever les agrafes
per applicare e togliere le agrafes

mit Schraubschluß
screw lock
articulación a tornillo
articulation à vis
articolazione a vite



Nahtbesteck

Suture Set
Estuche para suturas
Trousse à suture
Set per sutura



Paramount Mini-Assistent
PST-11-2978
165 x 90 x 20 mm

Mathieu needleholder, 14 cm

Surgical needles, different sizes

Needle case, 50 x 25 mm, perforated

Michel suture clip forceps

Michel suture clips, on clip holder

Scalpel handle, No. 4

Scalpel blades, different sizes

Operating scissors, straight, sharp/blunt,

Dressing Forceps, delicate, 12,5 cm

Protection pouch, plastic

Naht
Suture
Sutura
Suturie
Sutura

11



Quality Instruments

Nahtbesteck

Suture Set
Estuche para suturas
Trousse à suture
Set per sutura



Paramount Assistant Standard
PST-11-2979
165 x 90 x 28 mm

**complete, in metal case,
(instruments with box-lock), consisting of:**

- Removable, perforated storage trays
- Mathieu needleholder, 14 cm
- Surgical needles, different sizes
- Needle case, 65 x 42 mm, perforated
- Michel suture clip forceps
- Michel suture clips, on clip holder
- Scalpel handle, No. 4
- Scalpel blades, different sizes
- Operating scissors, straight, sharp/blunt, 13 cm
- Dressing Forceps, 11,5 cm
- Dissecting forceps, 1:2 teeth, 12 cm
- Hunter splinter forceps, 10,5 cm
- Kocher artery forceps, straight, 1:2 teeth, 13 cm
- Myrtle leaf probe, 13 cm
- Protection pouch, plastic

Nahtbesteck

Suture Set
Estuche para suturas
Trousse à suture
Set per sutura



Paramount Multi - Assisten
PST-11-2980
200 x 100 x 27 mm

**complete, in metal case,
(instruments with box-lock), consisting of:**

- Removable, perforated storage trays
- Mathieu needleholder, 17 cm
- Surgical needles, different sizes
- Needle case, 65 x 42 mm, perforated
- Michel suture clip forceps
- Michel suture clips, on clip holder
- Scalpel handle, No. 4
- Scalpel blades, different sizes
- Operating scissors, straight, sharp/blunt, 14,5 cm
- Dressing Forceps, 14,5 cm
- Dissecting forceps, 1:2 teeth, 14,5 cm
- Feilchenfeldt splinter forceps, 11,5 cm
- Kocher artery forceps, straight, 1:2 teeth, 14 cm
- Myrtle leaf probe, 13 cm
- Protection pouch, plastic



Venae Sectio-Besteck

Venae sectio Set
Estuche para venae sectio
Trousse pour venae sectio
Set per venae sectio



Venaesectio
PST-11-2981
200 x 100 x 32 mm

**complete, in metal case,
(instruments with box-lock), consisting of:**

- Scalpel handle, No. 4
- Scalpel blades, different sizes
- Vascular scissors, straight, button ended, 11,5 cm
- Scissors, curved, sharp/sharp, 10,5 cm
- Semken dressing forceps, 12 cm
- Semken dissecting forceps, 1:2 teeth, 12 cm
- Mosquito artery forceps, curved, 12,5 cm
- Mosquito artery forceps, straight, 1:2 teeth, 12,5 cm
- Backhaus towel clamp, 8 cm
- Finsen spreader, adjustable, 7 cm
- Doyen grooved director, curved, 14 cm
- Mathieu needleholder, 14 cm
- Surgical needles, different sizes
- Needle case, 65 x 42 mm, perforated
- Lange approximation forceps, self-retaining
- Michel suture clip forceps
- Michel suture clips, on clip holder
- Ligature needle, fine
- Protection pouch, plastic

Set Kleine „Wundversorgung“

“Small Suture Set”
Set “Sutura pequeña”
Set «Suture petite»
Set “Piccole ferrite”



PST-11-2982

Complete, in Microstop®-miniset-container, Consisting Of:

- Scalpel handle, No. 3
- Operating scissors, sharp/blunt, curved, 14,5 cm
- Dissecting scissors, blunt/blunt, curved, 14,5 cm
- Dissecting forceps, 1:2 teeth, 14,5 cm
- Dissecting forceps, 1:2 teeth, narrow, 14,5 cm
- Dressing forceps, delicate, 14,5 cm
- Splinter forceps, Feilchenfeldt, 9 cm
- Towel clamp, Tohoku, blunt, 10 cm
- Mosquito artery forceps, curved, 12,5 cm
- Artery forceps, Pean, delicate, curved, 16 cm
- Artery forceps, Kocher, 1:2 teeth, curved, 16 cm

- Dressing forceps, Gross-Maier, straight, 22 cm
- TC-Needleholder, Crile-Wood, 15 cm
- Hooklets, delicate, sharp, 2 prongs, 16 cm
- Wound spreader, blunt, 3:4 teeth, 13 cm
- Round dish, 61 x 30 mm, 0,07 l
- MicroStop®-Miniset-Container, 301 x 189 x 41 mm
- Identification lable for Miniset-Container, with text
- Wrapping towel, 50 x 50 cm
- Spring frame for Miniset-Container



Verband
Dressings
Vendajes
Pansements
Bendaggi



12

93 - 94

Knochenchirurgie
Bone Surgery
Cirugía ósea
Chirurgie osseuse
Chirurgie ossea



13

95 - 98

Knochenchirurgie
Bone Surgery
Cirugía ósea
Chirurgie osseuse
Chirurgie ossea



14

99 - 119

Verband

Dressings
Vendajes
Pansements
Bendaggi

12



Quality Instruments

Verbandscheren

Bandage Scissors
Tijeras para vendajes
Ciseaux pour pansements
Forbici per bendaggi

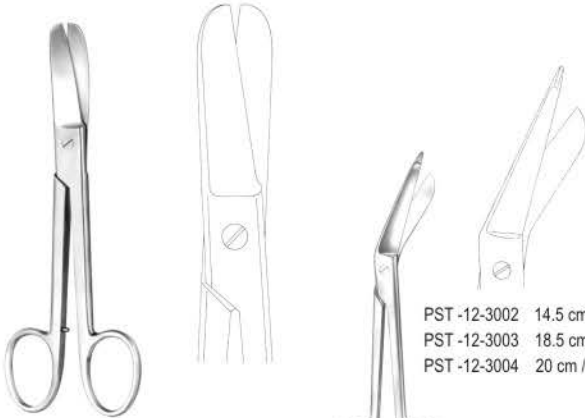

Lorenz
PST -12-3001
24 cm / 9 4/8"
kräftiges Modell
heavy pattern
modelo fuerte
modèle fort
modello forte

Lister
PST -12-3002 - PST -12-3004

PST -12-3002 14.5 cm / 5 6/8"
PST -12-3003 18.5 cm / 7 2/8"
PST -12-3004 20 cm / 7 7/8"



Gippscheren

Plaster Shears
Tijeras para yeso
Ciseaux pour plâtre
Forbici per gesso

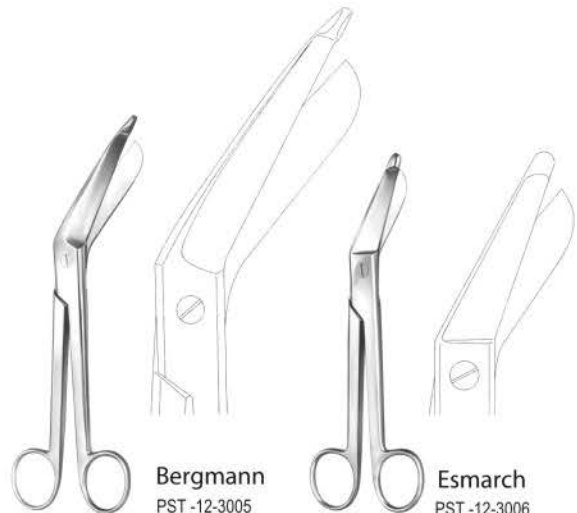

Bergmann
PST -12-3005
23 cm / 9"
kräftiges Modell
heavy pattern
modelo fuerte
modèle fort
modello forte

Esmarch
PST -12-3006
20 cm / 7 7/8"
kräftiges Modell, kurze Blätter
heavy pattern, short blades
modelo fuerte, hojas cortas
modèle fort, lames courtes
modello forte, lame curve



Verbandscheren, Gippscheren

Bandage Scissors, Plaster Shears
Tijeras para vendajes, Tijeras para yeso
Ciseaux pour pansements, Ciseaux pour plâtre
Forbici per bendaggi, Forbici per gesso



PST -12-3007 15.5 cm / 6 1/8"
PST -12-3008 19 cm / 7 4/8"

PST -12-3009 24 cm / 9 4/8"
PST -12-3010 24 cm / 9 4/8"
eine Schneide gezahnt
one toothed cutting edge
una hoja dentada
une lame dentelée
una lama dentata

Universal

PST -12-3007 - PST -12-3008
schwarze Kunststoffringe, autoklavierbar
black plastic rings, autoclavable
anillos negros, plástico, autoclavable
avec anneaux en matière plastique noire, autoclavable
anelli neri di materia plastica, sterilizzabile in autoclave

Bruns
PST -12-3009 - PST -12-3010



Gippscheren

Plaster Shears
Tijeras para yeso
Ciseaux pour plâtre
Forbici per gesso

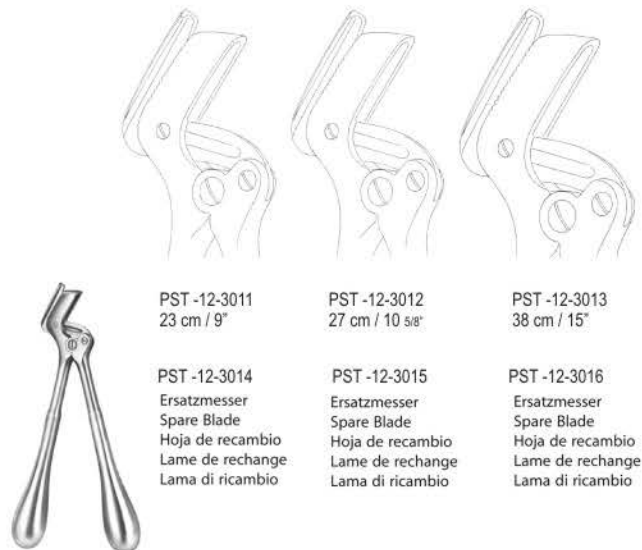

PST -12-3011
23 cm / 9"

PST -12-3012
27 cm / 10 5/8"

PST -12-3013
38 cm / 15"

PST -12-3014
Ersatzmesser
Spare Blade
Hoja de recambio
Lame de rechange
Lama di ricambio

PST -12-3015
Ersatzmesser
Spare Blade
Hoja de recambio
Lame de rechange
Lama di ricambio

PST -12-3016
Ersatzmesser
Spare Blade
Hoja de recambio
Lame de rechange
Lama di ricambio

Stille-Martin
PST -12-3011 - PST -12-3016



Verband

Dressings
Vendajes
Pansements
Bendaggi

12



Quality Instruments

Verbandscheren, Gipsscheren
Bandage Scissors, Plaster Shears
Tijeras para vendajes, Tijeras para yeso
Ciseaux pour pansements, Ciseaux pour plâtre
Forbici per bendaggi, Forbici per gesso

TC GOLD

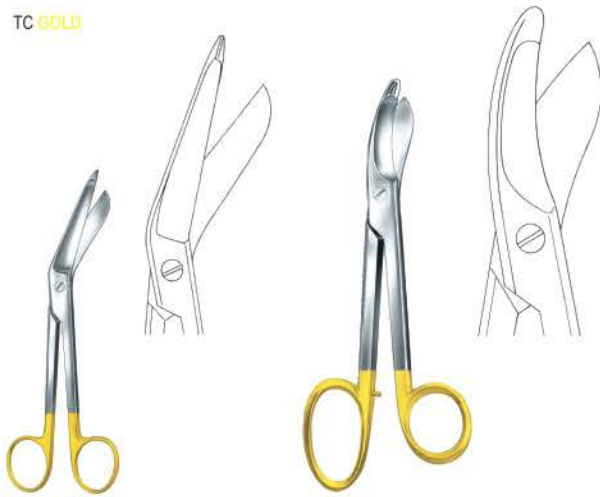

Lister
PST -12-3017
18 cm / 7 1/8"

Bruns
PST -12-3018
23.5 cm / 9 2/8"

Gipsmesser
Plaster Knives
Cuchillos para yeso
Couteaux pour plâtre
Coltelli per gesso



Hopkins

PST -12-3019
20 cm / 7 7/8"
mit Holzheft
with wooden handle
con mango de madera
avec manche en bois
con manico di legno

Esmarch

PST -12-3020
18 cm / 7 1/8"

Reiner

PST -12-3021
18 cm / 7 1/8"

Martin

PST -12-3022
20.5 cm / 8 1/8"
mit Holzheft
with wooden handle
con mango de madera
avec manche en bois
con manico di legno



Gipsspreizer
Plaster Spreaders
Separadores para yeso
Pincas pour plâtre
Pinze per gesso

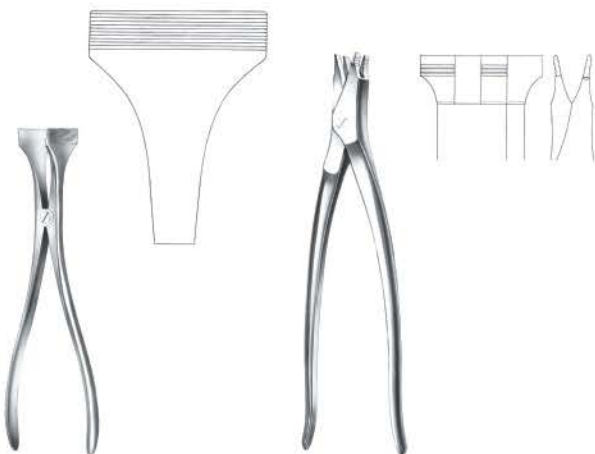

Hennig
PST -12-3023
28 cm / 11"

Quattro
PST -12-3024
23 cm / 9"



Gipsabreißzangen
Plaster Breakers
Pinzas para romper yeso
Pincas pour rompre plâtre
Pinze per rompere gesso

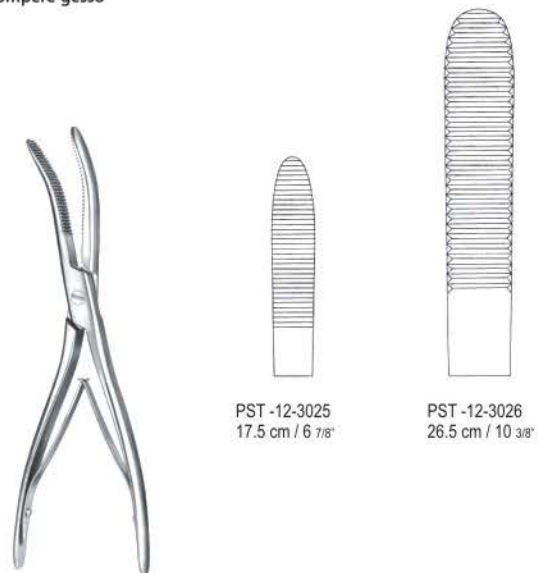

PST -12-3025
17.5 cm / 6 7/8"

PST -12-3026
26.5 cm / 10 3/8"

Wolff

PST -12-3025 - PST -12-3026



Knochenchirurgie

Bone Surgery
Cirugía ósea
Chirurgie osseuse
Chirurgie ossea

13



Quality Instruments

Amputationssägen

Amputation Saws
Sierras de amputación
Scies à amputation
Seghe per amputazione

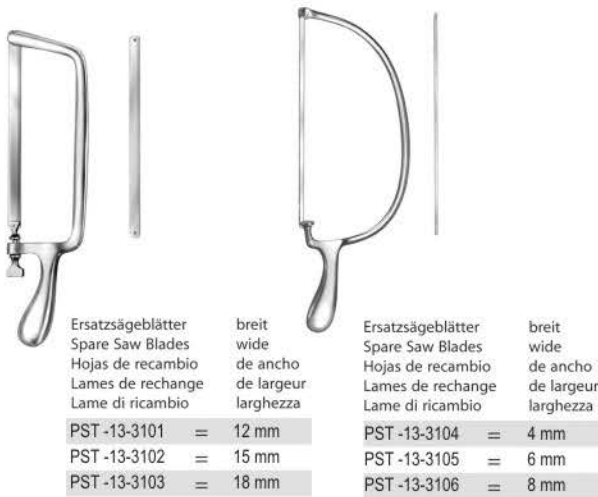

Ersatzsägeblätter Spare Saw Blades Hojas de recambio Lames de rechange Lame di ricambio	breit wide de ancho de largeur larghezza	Ersatzsägeblätter Spare Saw Blades Hojas de recambio Lames de rechange Lame di ricambio	breit wide de ancho de largeur larghezza
PST -13-3101	= 12 mm	PST -13-3104	= 4 mm
PST -13-3102	= 15 mm	PST -13-3105	= 6 mm
PST -13-3103	= 18 mm	PST -13-3106	= 8 mm

Charrière
PST -13-3101 - PST -13-3103
35 cm / 13 5/8"

Bier
PST -13-3104 - PST -13-3106
40.5 cm / 16"

Amputationssägen

Amputation Saws
Sierras de amputación
Scies à amputation
Seghe per amputazione

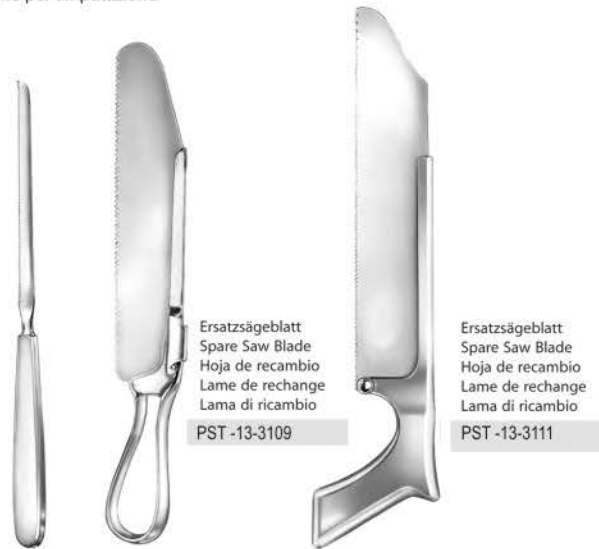

Ersatzsägeblatt Spare Saw Blade Hoja de recambio Lame de rechange Lama di ricambio	Ersatzsägeblatt Spare Saw Blade Hoja de recambio Lame de rechange Lama di ricambio
PST -13-3109	PST -13-3111

Langenbeck
PST -13-3107
24 cm / 9 4/8"

Charrière
PST -13-3108
26.5 cm / 10 3/8"

Satterlee
PST -13-3110
29 cm / 11 3/8"



Reibahlen

Reamer, Hand Drills
Escariadores, Perforadores de mano
Pointes-carrées, Perforateurs à main
Puntruoli, Perforatori a mano



PST -13-3112
13 cm / 5 1/8"

Perthes
PST -13-3113
18 cm / 7 1/8"

Perthes
PST -13-3114
21.5 cm / 8 4/8"

PST -13-3115
14 cm / 5 1/8"
eine Seite konkav
one side concave
un lado cóncavo
un côté concave
un lato concavo



Handbohrapparate

Hand Drills
Perforadores de mano
Perforateurs à main
Perforatori a mano



Stille-Sherman
PST -13-3117

komplett, mit drei Bohrern
complete, with three twist drills
completo, con tres brocas
complet, avec trois fraises
completo, con tre punte

Stille
PST -13-3116
20.5 cm / 8"

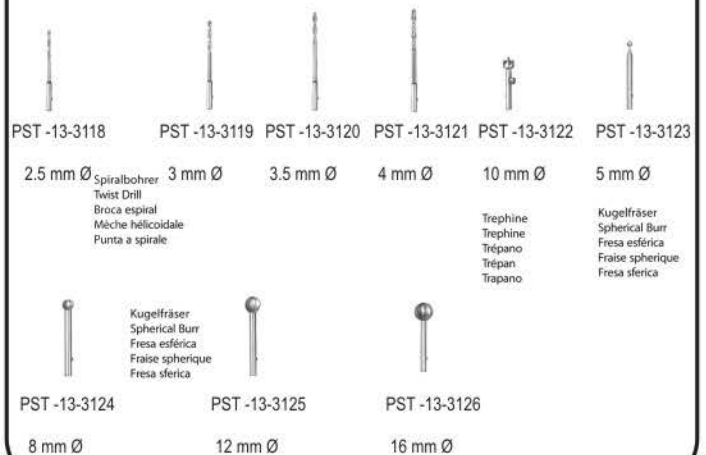

PST -13-3118	PST -13-3119	PST -13-3120	PST -13-3121	PST -13-3122	PST -13-3123
2.5 mm Ø	3 mm Ø	3.5 mm Ø	4 mm Ø	10 mm Ø	5 mm Ø
Spiralbohrer Twist Drill Broca espiral Mèche hélicoïdale Punta a spirale				Trepine Trepino Trépano Trapano	Kugelfräser Spherical Burr Fresa esférica Fraise spherique Fresa sferica
PST -13-3124	PST -13-3125	PST -13-3126			
8 mm Ø	12 mm Ø	16 mm Ø			



Knochenchirurgie

Bone Surgery
Cirugía ósea
Chirurgie osseuse
Chirurgie ossea

13



Quality Instruments

Handbohrapparate

Hand Drills
Perforadores de mano
Perforateurs à main
Perforatori a mano



Fig. 1 PST-13-3127 Fig. 2 PST-13-3128 Fig. 3 PST-13-3129 Fig. 4 PST-13-3130 Fig. 5 PST-13-3131 Fig. 6 PST-13-3132



Hudson
PST-13-3127 - PST-13-3135
28 cm / 11"

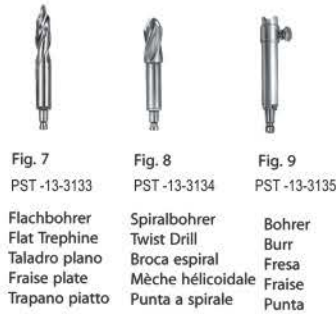

Fig. 7 PST-13-3133 Fig. 8 PST-13-3134 Fig. 9 PST-13-3135

Flachbohrer Flat Trephine Taladro plano Fraise plate Trapano piatto	Spiralbohrer Twist Drill Broca espiral Mèche hélicoïdale Punta a spirale	Bohrer Burr Fresa Fraise Punta
---------------------------------------------------------------------------------	--------------------------------------------------------------------------------------	--------------------------------------------



Handbohrapparate

Hand Drills
Perforadores de mano
Perforateurs à main
Perforatori a mano

PST-13-3137
Bohrer
Twist Drill
Broca espiral
Mèche hélicoïdale
Punta a spirale

Satz mit 3
set of 3
juego de 3
Serie di 3
2 x = 70 x 3,2 mm
1 x = 90 x 3,2 mm



Moore
PST-13-3136
27.5 cm / 10 7/8"

komplett, mit einem Satz Bohrer
Art.-Nr. PST-13-3137
complete, with a set of twist drills
ref. PST-13-3137
completo, con un juego de brocas
ref. PST-13-3137
complet, avec un jeu de fraises
réf. PST-13-3137
completo, con una serie di punte
rif. PST-13-3137

Martin
PST-13-3138



Jacobs
PST-13-3139

Spannfutter
Chuck
Mandril de sujeción
Mandrin à trois mâchoires
Mandrile a tre ganasce
mit Borchardt-Schaft
with Borchardt shaft
con vástago Borchardt
avec tige Borchardt
con asta Borchardt
max. Öffnungsweite
max. opening
apertura máx.
pour montage de tiges jusqu'à
apertura máx.
6,35 mm



PST-13-3140
Spannschlüssel
Wrench
Llave
Clé
Chiave per il mandrino



Knochenhalteklammern, Distractionsklammer

Bone Holding Clamps, Traction Bar
Grapas porta-huesos, Barra de tracción
Daviers à os, Ecarteurs pour les daviers à os
Tenaglia per ossa, Divaricatore per the tenaglia per ossa

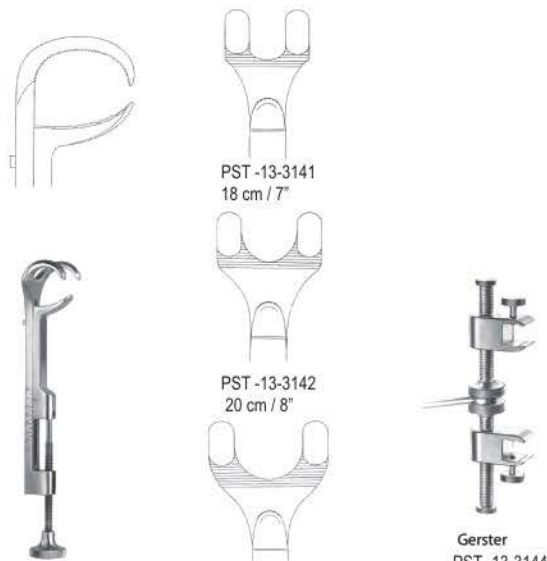

PST-13-3141
18 cm / 7"

PST-13-3142
20 cm / 8"

PST-13-3143
22 cm / 8 1/8"

Gerster
PST-13-3144

Gerster-Lowman
PST-13-3141 - PST-13-3143



Drahtzwirbelzangen

Wire Twisting Forceps
Pinzas para torcer alambre
Pinces à torsader le fil
Pinze per ritorcere fili

TC GOLD



PST-13-3145
15.5 cm / 6 1/8"

PST-13-3146
18 cm / 7 1/8"

PST-13-3147
15.5 cm / 6 1/8"

PST-13-3148
18 cm / 7 1/8"

PST-13-3145 - PST-13-3146

PST-13-3147 - PST-13-3148

PST-13-3149
15.5 cm / 6 1/8"

PST-13-3150
20 cm / 7 7/8"

Martin
PST-13-3151
14.5 cm / 5 6/8"





Tonnenzange, Kombinationszange, Flachzangen

Vise Grip, Combi-Flat Nose Plier
Alicates de pico plano, Combi-Alicate de alambre
Pincers plates, Combi-Pince pour fils
Tenaglie piate, Combi-Pinza per fili

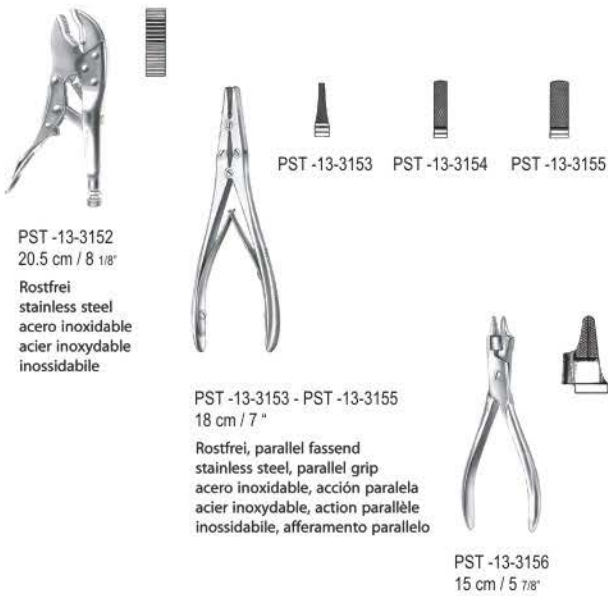

PST -13-3152
20,5 cm / 8 1/8"
Rostfrei
stainless steel
acero inoxidable
acier inoxydable
inossidabile

PST -13-3153 - PST -13-3155
18 cm / 7"

Rostfrei, parallel fassend
stainless steel, parallel grip
acero inoxidable, acción paralela
acier inoxydable, action parallèle
inossidabile, afferamento parallelo

PST -13-3156
15 cm / 5 7/8"

Flachzangen

Flat Nose Pliers
Alicates de pico plano
Pincers plates
Tenaglie piate

TC GOLD



PST -13-3157 PST -13-3158 PST -13-3159

PST -13-3157 - PST -13-3159
18 cm / 7 1/8"
parallel fassend
parallel grip
acción paralela
action parallèle
afferamento parallelo

PST -13-3160
13,5 cm / 5 3/8"

PST -13-3161
19 cm / 7 4/8"



Flachzangen

Flat Nose Pliers
Alicates de pico plano
Pincers plates
Tenaglie piate



Hackstock
PST -13-3162
16 cm / 6 2/8"

mit Längsrille
with longitudinal groove
con ranura longitudinal
avec rainure longitudinale
con scannellatura longitudinale

PST -13-3165
19 cm / 7 4/8"
Spitz- und Flachzange
Flat Nose Plier, pointed
Alicates planos/agudos
Pincers plates / aiguës
Tenaglie piate/appuntate

PST -13-3163 PST -13-3164

mit Kreuzrille
with crosswise groove
con ranura en forma de cruz
avec rainures croisées
con scannellatura a croce

PST -13-3163 - PST -13-3164
17 cm / 6 5/8"

Drahtkneifzangen

Wire Cutting Pliers
Alicates para cortar alambre
Pincers à couper le fil
Tenaglie tagliafili



PST -13-3166
18,5 cm / 7 2/8"

Schnittbreite
Cutting width
Ancho de cortar
Largeur de coupe
Ampiezza di taglio
Ø 13,5 mm
für weiche Drähte bis
for soft wires up to
para alambres blandos hasta
pour fils mous jusqu'à
per fili molli fino a
Ø 2,4 mm
für harte Drähte bis
for hard wires up to
para alambres duros hasta
pour fils durs jusqu'à
per fili metallici duri fino a
Ø 1,8 mm

Ø 14,5 mm
Ø 2,2 mm
Ø 2,0 mm

Martin "Diamant"
PST -13-3167
16 cm / 6 2/8"

Kopfschneider
Wire Cutter, front action
Alicate frontal para cortar alambre
Pincers coupantes frontales
Tenaglie tagliafili frontali





Seitenschneider

Wire Cutting Pliers
Tenazas de corte lateral
Pincers coupantes de côté
Tenaglia tagliafilati laterali



PST-13-3168
13 cm / 5 1/8"

für weiche Drähte bis
for soft wires up to
para alambres blandos hasta
pour fils mous jusqu'à
per fili molli fino a
Ø 1,5 mm

für harte Drähte bis
for hard wires up to
para alambres duros hasta
pour fils durs jusqu'à
per fili metallici duri fino a
Ø 1,0 mm

kräftiges Modell
heavy pattern
modelo fuerte
modèle fort
modello forte



PST-13-3169
17 cm / 6 5/8"

für weiche Drähte bis
for soft wires up to
para alambres blandos hasta
pour fils mous jusqu'à
per fili molli fino a
Ø 2,0 mm

für harte Drähte bis
for hard wires up to
para alambres duros hasta
pour fils durs jusqu'à
per fili metallici duri fino a
Ø 1,7 mm



PST-13-3170
23 cm / 9"

für weiche Drähte bis
for soft wires up to
para alambres blandos hasta
pour fils mous jusqu'à
per fili molli fino a
Ø 2,8 mm

für harte Drähte bis
for hard wires up to
para alambres duros hasta
pour fils durs jusqu'à
per fili metallici duri fino a
Ø 2,2 mm

Kopfschneider, I.M.F. Stahldraht

Wire Cutter, front action, I.M.F. Bone Wire
Alicate frontal para cortar alambre, Alambre para I.M.F.
Pince coupante frontale, Fil à I.M.F.
Tenaglia tagliafilati frontale, Filo per I.M.F.



PST-13-3171
38 cm / 15"

Kopfschneider
Wire Cutter, front action
Alicate frontal para cortar alambre
Pince coupante frontale
Tenaglia tagliafilati frontale

für weiche Drähte bis
for soft wires up to
para alambres blandos hasta
pour fils mous jusqu'à
per fili molli fino a
Ø 4,0 mm

für harte Drähte bis
for
para alambres duros hasta
pour fils durs jusqu'à
per fili metallici duri fino a
Ø 3,2 mm



PST-13-3172
26 cm / 10 2/8"

Kopfschneider
Wire Cutter, front action
Alicate frontal para cortar alambre
Pince coupante frontale
Tenaglia tagliafilati frontale



PST-13-3173
Ø 0,4 mm
I.M.F. Stahldraht
I.M.F. Bone Wire
Alambre para I.M.F.
Fil à I.M.F.
Filo per I.M.F.

Drahtumführungsnadeln, Drahtspanner

Wire Guides, Wire Tightener
Agujas pasa-hilo, Tensor cierra-hilo
Aiguilles passe-fils, Tendeur serre-fil
Aghi passafili, Strumento tendifili



Fig. 1
PST-13-3174
31 cm / 12 2/8"



Fig. 2
PST-13-3175
29 cm / 11 3/8"



Fig. 3
PST-13-3176
28 cm / 11"



Demel
PST-13-3174 - PST-13-3176



Loute
PST-13-3177
21 cm / 8 2/8"

Extensionsnägeln, Extensionsbügel

Extension Pins, Extension Bows
Clavos de extensión, Estribos para extensión
Clous à os, Etriers à extension
Chiodi per ossa, Archi per estensione



Steinmann
mit Trokarspitze
with trocar point
con punta de trocar
avec pointe de trocar
con punta di trequarti

PST-13-3178	=	14 cm / 5 4/8"
PST-13-3179	=	16 cm / 6 2/8"
PST-13-3180	=	18 cm / 7"
PST-13-3181	=	20 cm / 8"

PST-13-3178 - PST-13-3181



Böhler
PST-13-3182 - 3184

PST-13-3182	210 x 150 mm 8" x 6"	für Oberschenkel und Knie for femur and knee para fémur y rodilla pour fémur et genou per il femore ed il ginocchio
PST-13-3183	160 x 90 mm 6 2/8" x 4 1/8"	für Arm for arm para brazo pour bras per il braccio
PST-13-3184	210 x 110 mm 8 2/8" x 4 1/8"	für Oberschenkel und Knie for femur and knee para fémur y rodilla pour fémur et genou per il femore ed il ginocchio



Knochenchirurgie

Bone Surgery
Cirugía ósea
Chirurgie osseuse
Chirurgie ossea

14



Quality Instruments

Knochenmeißel, Hohlmeißel

Bone Chisels, Gouges
Cinceles, Gubias
Ciseaux-burins, Gouges
Scalpelli, Sgorbie



Virchow

PST -14-3201
7,5 cm / 3"
Schädelspalter
Skull Breaker
Cinzel rompe-cráneo
Burin pour le crâne
Scalpello per cranio



PST -14-3202
4 mm



PST -14-3203
4 mm

PST -14-3202 - PST -14-3203
17 cm / 6 7/8"



PST -14-3204
4 mm



PST -14-3205
4 mm



PST -14-3206
4 mm

Gardner
PST -14-3204 - PST -14-3206
17 cm / 6 7/8"
dreieckige Form
triangular shape
forma triangulada
forme triangulaire
forma triangolare



PST -14-3207
3 mm



PST -14-3208
5 mm

Snyder-O.S.U.

PST -14-3207 - PST -14-3208
17 cm / 6 7/8"



Osteotome, Flachmeißel, Hohlmeißel

Osteotomes, Chisels, Gouges
Osteótomos, Cinceles, Gubias
Ostéotomes, Ciseaux-burins, Gouges
Osteotomi, Scalpelli, Sgorbie



PST -14-3209
8 mm



PST -14-3214
8 mm



PST -14-3219
8 mm



PST -14-3210
10 mm



PST -14-3215
10 mm



PST -14-3220
10 mm



PST -14-3211
12 mm



PST -14-3216
12 mm



PST -14-3221
12 mm



PST -14-3212
14 mm

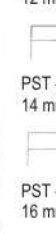

PST -14-3217
14 mm

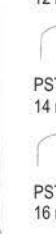

PST -14-3222
14 mm



PST -14-3213
16 mm



PST -14-3218
16 mm



PST -14-3223
16 mm

PST -14-3209 - PST -14-3213
13.5 cm / 5 3/8"

PST -14-3214 - PST -14-3218
13.5 cm / 5 3/8"

PST -14-3219 - PST -14-3223
13.5 cm / 5 3/8"



Flachmeißel, Hohlmeißel

Chisels
Cinceles
Ciseaux-burins
Scalpelli



PST -14-3224
13.5 cm / 5 3/8"
2 mm



PST -14-3229
17 cm / 6 7/8"
2 mm



PST -14-3225
13.5 cm / 5 3/8"
3 mm



PST -14-3230
17 cm / 6 7/8"
3 mm



PST -14-3226
13.5 cm / 5 3/8"
4 mm



PST -14-3231
17 cm / 6 7/8"
4 mm



PST -14-3227
13.5 cm / 5 3/8"
5 mm



PST -14-3232
17 cm / 6 7/8"
5 mm



PST -14-3228
13.5 cm / 5 3/8"
6 mm



PST -14-3233
17 cm / 6 7/8"
6 mm

Partsch

PST -14-3224 - PST -14-3233



Partsch

PST -14-3234 - PST -14-3243



PST -14-3234
13.5 cm / 5 3/8"
2 mm



PST -14-3239
16.5 cm / 6 4/8"
2 mm



PST -14-3235
13.5 cm / 5 3/8"
3 mm



PST -14-3240
16.5 cm / 6 4/8"
3 mm



PST -14-3236
13.5 cm / 5 3/8"
4 mm



PST -14-3241
16.5 cm / 6 4/8"
4 mm



PST -14-3237
13.5 cm / 5 3/8"
5 mm



PST -14-3242
16.5 cm / 6 4/8"
5 mm



PST -14-3238
13.5 cm / 5 3/8"
6 mm



PST -14-3243
16.5 cm / 6 4/8"
6 mm



Flachmeißel, Hohlmeißel

Chisels
Cinceles
Ciseaux-burins
Scalpelli



PST -14-3244
4 mm



PST -14-3245
6 mm



PST -14-3246
8 mm



PST -14-3247
10 mm



PST -14-3248
12 mm

Alexander

PST -14-3244 - 3248
17.5 cm / 6 7/8"
massiv
solid
macizo
solide
pieno



PST -14-3249
4 mm



PST -14-3250
6 mm



PST -14-3251
8 mm



PST -14-3252
10 mm



PST -14-3253
12 mm

Alexander

PST -14-3249 - 3253
17.5 cm / 6 7/8"
massiv
solid
macizo
solide
pieno





Flachmeißel, Osteotome, Hohlmeißel

Chisels, Osteotomes, Gouges
Cinceles, Osteótomos, Gubias
Ciseaux-burins, Ostéotomes, Gouges
Scalpelli, Osteotomi, Sgorbie



PST -14-3254
10 mm



PST -14-3258
10 mm



PST -14-3262
10 mm



PST -14-3255
15 mm



PST -14-3259
15 mm



PST -14-3263
15 mm



PST -14-3256
20 mm



PST -14-3260
20 mm



PST -14-3264
20 mm



PST -14-3257
25 mm



PST -14-3261
25 mm



PST -14-3265
25 mm

Stille

PST -14-3254 - PST -14-3257
20,5 cm / 8 1/8"

Stille

PST -14-3258 - PST -14-3261
20,5 cm / 8 1/8"

Stille

PST -14-3262 - PST -14-3265
20,5 cm / 8 1/8"

Meißelklingen, Meißelgriff

Chisel Blades, Chisel Handle
Hojas de cincel, Mango para hojas de cincel
Lames-gouges, Manche pour ciseaux-burins
Lame per sgorbie, Manico per scalpello

Meißelklingen, auswechselbar
Chisel blades, interchangeable
Hojas de cincel, intercambiables
Lames ciseaux-burins, interchangeables
Lame intercambiabili



PST -14-3266 - 3276
13,5 cm / 5 3/8"
auswechselbar
interchangeable
intercambiabile
interchangeables
intercambiabili



PST -14-3266
13,5 cm / 5 3/8"
25 mm



PST -14-3267
13,5 cm / 5 3/8"
25 mm



PST -14-3268
13,5 cm / 5 3/8"
25 mm



PST -14-3269
8 cm 3 1/8"
5mm



PST -14-3270
8 cm / 3 1/8"
10 mm



PST -14-3271
8 cm / 3 1/8"
15 mm



PST -14-3272
8 cm / 3 1/8"
25 mm



PST -14-3273
8 cm / 3 1/8"
5 mm



PST -14-3274
8 cm / 3 1/8"
10 mm



PST -14-3275
8 cm / 3 1/8"
16 mm



PST -14-3276
8 cm / 3 1/8"
25 mm

PST -14-3277
18,5 cm / 7 2/8"
Fz

Osteotomklingen, auswechselbar
Osteotome blades, interchangeable
Hojas de osteótomo, intercambiabile
Lame per osteotomia, intercambiabili
Lame per osteotomia, intercambiabili

Hohlmeißelklingen, auswechselbar
Gouge blades, interchangeable
Hojas de gubia, intercambiabile
Lames-gouges, interchangeable
Lame intercambiabili, concavo

Spongiosaentnahmemeißel

Spongiosa Gouges
Cinceles de esponjosa
Ciseaux-burinx pour spongiosa
Scalpelli per spongiosa



PST -14-3278
5 mm



PST -14-3281
5 mm



PST -14-3279
10 mm



PST -14-3282
10 mm



PST -14-3280
15 mm



PST -14-3283
15 mm

Lexer

PST -14-3278 - PST -14-3280
24,5 cm / 9 5/8"

Fz

Lexer

PST -14-3281 - PST -14-3283
24,5 cm / 9 5/8"

Fz

Osteotome, Hohlmeißel

Osteotomes, Gouges
Osteótomos, Gubias
Ostéotomes, Gouges
Osteotomi, Sgorbie



PST -14-3284
4 mm



PST -14-3285
6 mm



PST -14-3286
8 mm

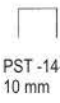

PST -14-3287
10 mm



PST -14-3288
12 mm



PST -14-3289
4 mm



PST -14-3290
6 mm

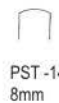

PST -14-3291
8 mm



PST -14-3292
10 mm



PST -14-3293
12 mm

Lexer-Mini

PST -14-3284 - PST -14-3288
18 cm / 7 1/8"

Fz

Lexer-Mini

PST -14-3289 - PST -14-3293
18 cm / 7 1/8"

Fz





Osteotome, Hohlmeißel

Osteotomes, Gouges
Osteótomos, Gubias
Ostéotomes, Gouges
Osteotomi, Sgorbie

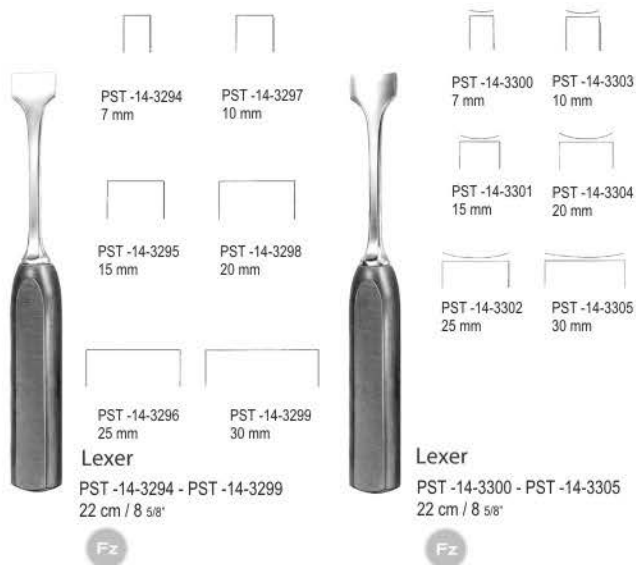

Osteotome

Osteotomes
Osteótomos
Ostéotomes
Osteotomi

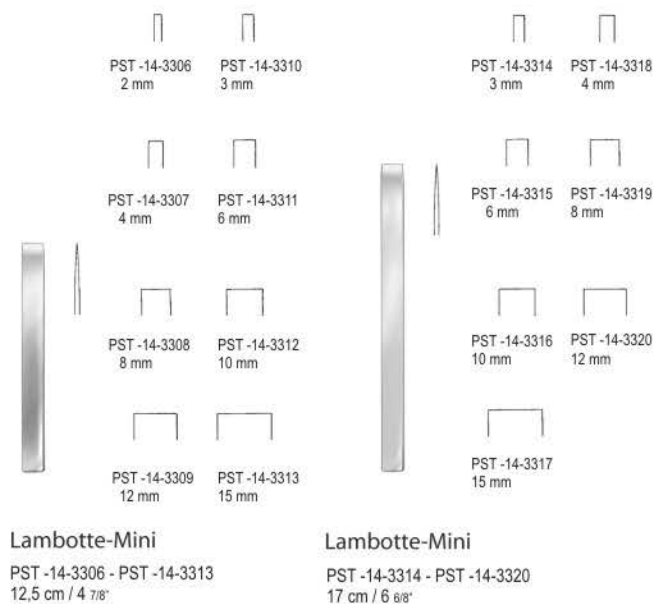

Osteotome

Osteotomes
Osteótomos
Ostéotomes
Osteotomi

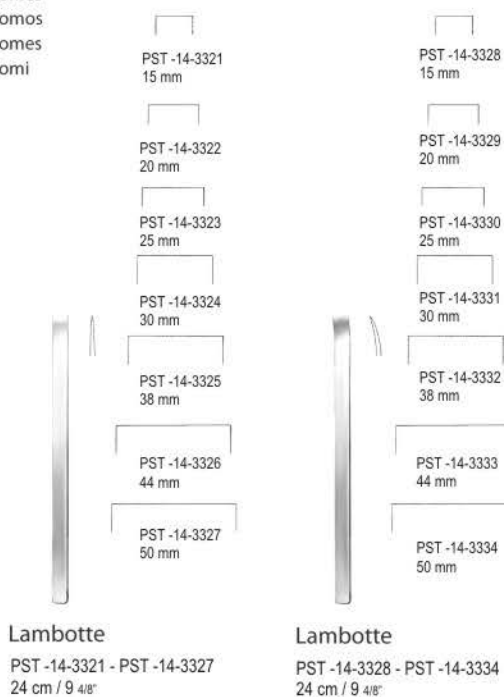

Osteotome

Osteotomes
Osteótomos
Ostéotomes
Osteotomi

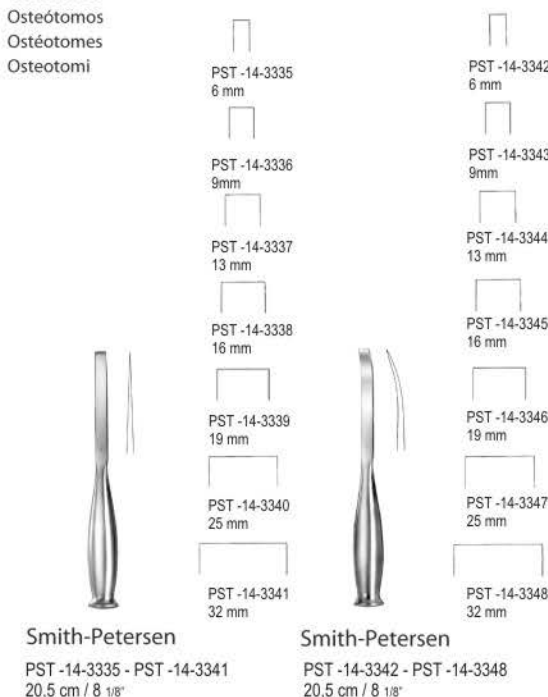

Knochenchirurgie

Bone Surgery
Cirugía ósea
Chirurgie osseuse
Chirurgie ossea

14



Quality Instruments

Hohlmeißel

Gouges
Gubias
Gouges
Sgorbie

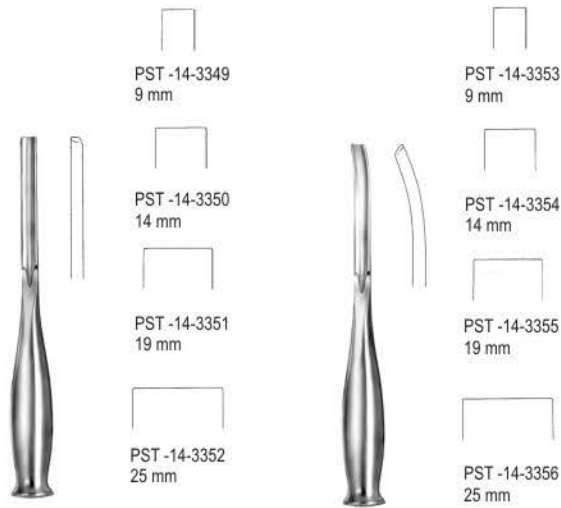

Smith-Petersen

PST -14-3349 - PST-14-3352
20.5 cm / 8 1/8"

Smith-Petersen

PST -14-3353 - PST-14-3356
20.5 cm / 8 1/8"

Osteotome, Flachmeißel

Osteotomes, Chisels
Osteótomos, Cinceles
Ostéotomes, Ciseaux-burins
Osteotomi, Scalpelli

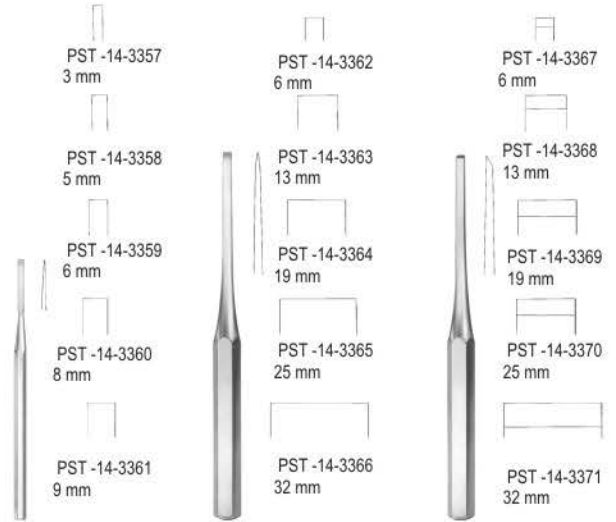

Hoke

PST -14-3357 - PST-14-3361
17 cm / 6 6/8"

Hibbs

PST -14-3362 - PST-14-3366
24.5 cm / 9 5/8"

Hibbs

PST -14-3367 - 3371
24.5 cm / 9 5/8"



Osteotome, Hohlmeißel

Osteotomes, Gouges
Osteótomos, Gubias
Ostéotomes, Gouges
Osteotomi, Sgorbie

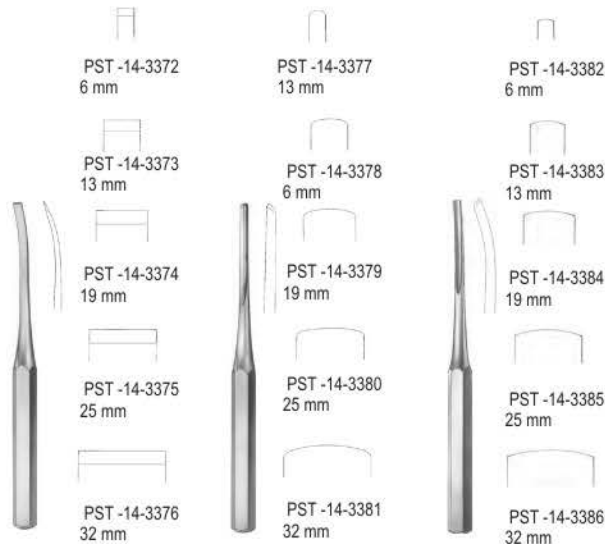

Hibbs

PST -14-3372 - 3376
24.5 cm / 9 5/8"

Hibbs

PST -14-3377 - 3381
24.5 cm / 9 5/8"

Hibbs

PST -14-3382 - 3386
24.5 cm / 9 5/8"



Knochenraspel

Bone Rasps
Escofinas para hueso
Râpes pour os
Raspe per ossa

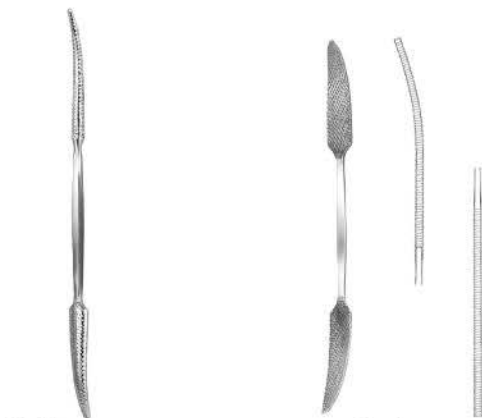

Putti

PST -14-3387
30 cm / 11 6/8"
rund/halbrund
round / semi round
redonda / semi-redonda
ronde / semi-ronde
rotondo / semi-rotondo

Putti

PST -14-3388
27 cm / 10 5/8"
gebogen/gerade
curved / straight
curva / recta
courbée / droite
curvo / diritto

Knochenchirurgie

Bone Surgery
Cirugía ósea
Chirurgie osseuse
Chirurgie ossea

14



Quality Instruments

Knochenbiopsieinstrumente

Bone Biopsy Instruments
Instrumento para biopsia ósea
Instrument pour biopsie osseuse
Strumento per biopsia ossea



Champy-OSU

PST -14-3389
22 cm / 8 5/8"
Ø 5.0 x 3.8 mm

Bestehend aus einem Trokar, einer gezahnten Trepine und einem Kolben zur Entnahme von Knochentransplantaten aus Tibia und Beckenkamm mittels eines geschlossenen Verfahrens

Consisting of trocar, a toothed trephine and a plunger for taking tibial and iliac bone grafts through a closed technique

Compuesto por un trócar, un trépano dentado y un émbolo para obtener injertos óseos tibiales e iliacos mediante una técnica cerrada

Composé d'un trocart, d'une tréphine dentée et d'un piston pour le prélèvement de greffes osseuses de la tibia ou de la crête iliaque par une technique fermée

Composto di un trequarti, una camicia dentata ed un pistone per il prelievo degli innesti ossei dalla tibia e dalla cresta iliaca tramite una tecnica chirurgica a cielochiuso

Stößel

Tampers
Punzones metálicos
Pilons métalliques
Pestoni metallici



PST -14-3390 Ø 2.0 mm
PST -14-3391 Ø 3.0 mm
PST -14-3392 Ø 4.0 mm
PST -14-3393 Ø 5.0 mm

PST -14-3394 Ø 6.0 mm
PST -14-3395 Ø 8.0 mm
PST -14-3396 Ø 10 mm

PST -14-3390 - PST -14-3396
15.5 cm / 6 1/8"

Hämmer

Mallets
Martillos
Maillets
Martelli



PST -14-3397
24 cm / 9 4/8"

Gewicht Kopf
weight head
peso cabeza
poids tête
peso testa
275 g Ø 26 mm

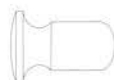

PST -14-3400
20,5 cm / 8 1/8"

120 g Ø 25 mm

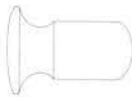

PST -14-3401
21 cm / 8 2/8"

180 g Ø 230 mm

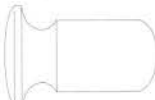

PST -14-3402
21,5 cm / 8 4/8"

260 g Ø 35 mm



PST -14-3398
24 cm / 9 4/8"

320 g Ø 28 mm



PST -14-3399
24 cm / 9 4/8"

340 g Ø 30 mm



Doyen

PST -14-3400 - PST -14-3402
21 cm / 9 4/8"

Williger

PST -14-3397 - 3399
24 cm / 9 4/8"
bleigefüllt
lead filled
relleno de plomo
remplissage de plomb
ripieno di piombo

Hämmer

Mallets
Martillos
Maillets
Martelli

Gewicht Kopf
weight head
peso cabeza
poids tête
peso testa
220 g Ø 30 mm



PST -14-3404

Kopf head
cabeza peso
tête poids
testa peso
Ø 19 mm 230 g

Kopf head
cabeza peso
tête poids
testa peso
Ø 30 mm 300 g



Collin

PST -14-3403
20 cm / 7 7/8"



Lucae

PST -14-3404 - PST -14-3405
19.5 cm / 7 5/8"



PST -14-3405

Kopf head
cabeza peso
tête poids
testa peso
Ø 25 mm 260 g



Cottle

PST -14-3406
19 cm / 7 4/8"
plan/konvex
plano / convexo
plano / convexe
plano / convesso

Knochenchirurgie

Bone Surgery
Cirugía ósea
Chirurgie osseuse
Chirurgie ossea

14



Quality Instruments

Hämmer

Mallets
Martillos
Maillets
Martelli



PST-14-3410

Ersatzbacken (Paar)
Spare Facings (pair)
Tapas de repuesto (par)
Plaques de rechange (paire)
Placche di ricambio (paio)



Williger

PST-14-3407
16,5 cm / 6 4/8"

Kopf	Gewicht
head	weight
cabeza	peso
tête	poids
testa	peso
Ø 20 mm	140 g

PST-14-3408
26 cm / 10 2/8"

Fz	Ø 30 mm	450 g
----	---------	-------

Mead

PST-14-3409
19 cm / 7 4/8"

mit austauschbaren Kunststoffbacken
with interchangeable plastic disks
con tapas intercambiables
avec plaques interchangeables
con placche intercambiabili

Ø 27 mm 300 g

Hämmer

Mallets
Martillos
Maillets
Martelli



Partsch

PST-14-3411
19 cm / 7 4/8"

mit Hohlheft
with hollow handle
con mango hueco
avec manche creux
con manico vuoto

Kopf	Gewicht
head	weight
cabeza	peso
tête	poids
testa	peso
Ø 27 mm	300 g

PST-14-3412
26 cm / 10 2/8"

Fz	Kopf	Gewicht
	head	weight
	cabeza	peso
	tête	poids
	testa	peso
	Ø 45 mm	340 g

PST-14-3414
26 cm / 10 2/8"

ohne Bleifüllung
without lead filling
sin relleno de plomo
sans remplissage de plomb
senza ripieno di piombo

Fz	Ø 45 mm	240 g
----	---------	-------



Hämmer

Mallets
Martillos
Maillets
Martelli



PST-14-3416

Ersatzbacke
Spare facing
Tapa de repuesto
Placque de rechange
Placche di ricambio



PST-14-3415
26,5 cm / 10 3/8"

plan (Kunststoff), konvex (Stahl),
plane (nylon), convex (steel),
plano (nilón), convexo (acero),
plan (nylon), convexe (acier),
plano (nilon), convesso (acciaio).

Fz	Ø 32 mm	620 g
----	---------	-------

PST-14-3417
26,5 cm / 10 3/8"

Fz	Ø 32 mm	620 g
----	---------	-------

PST-14-3418
24 cm / 9 4/8"

Fz	Kopf	Gewicht
	head	weight
	cabeza	peso
	tête	poids
	testa	peso
	Ø 30 mm	460 g

Hämmer

Mallets
Martillos
Maillets
Martelli



PST-14-3420

Ersatzbacken (Paar)
Spare Facings (pair)
Tapas de repuesto (par)
Plaques de rechange (paire)
Placche di ricambio (paio)



PST-14-3419
24 cm / 9 4/8"

Fz	Kopf	Gewicht
	head	weight
	cabeza	peso
	tête	poids
	testa	peso
	Ø 37 mm	350 g

PST-14-3421
22 cm / 8 5/8"

Fz	Kopf	Gewicht
	head	weight
	cabeza	peso
	tête	poids
	testa	peso
	Ø 30 mm	130 g

PST-14-3422
26,5 cm / 10 3/8"

Fz	Kopf	Gewicht
	head	weight
	cabeza	peso
	tête	poids
	testa	peso
	Ø 30 mm	580 g



Knochenchirurgie

Bone Surgery
Cirugía ósea
Chirurgie osseuse
Chirurgie ossea

14



Quality Instruments

Hämmer

Mallets
Martillos
Maillets
Martelli



PST-14-3425

Ersatzbacken (Paar)
Spare Facings (pair)
Tapas de repuesto (par)
Plaques de rechange (paire)
Placche di ricambio (paio)



PST-14-3423
26,5 cm / 10 3/8"



Kopf head
Gewicht weight
cabeza peso
tête poids
testa peso
Ø 50 mm 1300 g



PST-14-3424
19 cm / 7 4/8"



Kopf head
Gewicht weight
cabeza peso
tête poids
testa peso
Ø 25 mm 300 g



Herbert
PST-14-3426
19 cm / 7 4/8"



für Ulnakopfprothesen
for ulna head prosthesis
para prótesis de la cabeza ulnar
pour prothèse de la tête ulna
protesi per la testa ulnare
Ø 25 mm 215 g

Scharfe Löffel

Bone Curettes
Cucharillas cortantes
Curettes tranchantes
Curette taglienti



Volkman
PST-14-3427 - PST-14-3436
17 cm / 6 5/8"

oval
oval
ovalada
ovale
ovala
Fz



Volkman
PST-14-3437 - PST-14-3441
27 cm / 10 5/8"

oval
oval
ovalada
ovale
ovala
Fz

Scharfe Löffel

Bone Curettes
Cucharillas cortantes
Curettes tranchantes
Curette taglienti



Schede
PST-14-3442 - 3448
17 cm / 6 5/8"
oval, mit Hohlheft
oval, with hollow handle
ovalada, con mango hueco
ovale, avec manche creux
ovala, con manico vuoto



Volkman
PST-14-3449 - 3458
17 cm / 6 5/8"



Bruns
PST-14-3459 - 3468
17 cm / 6 5/8"
rund, mit Hohlheft
round, with hollow handle
redonda, con mango hueco
rond, avec manche creux
rotonda, con manico vuoto

Scharfe Löffel

Bone Curettes
Cucharillas cortantes
Curettes tranchantes
Curette taglienti



Spratt
PST-14-3469 - 3477
17 cm / 6 5/8"
oval, mit Hohlheft
oval, with hollow handle
ovalada, con mango hueco
ovale, avec manche creux
ovala, con manico vuoto



Bruns
PST-14-3478 - 3486
23 cm / 9"
oval, massiv
oval, solid
ovalada, maciza
ovale, solide
ovala, solida



Scoville
PST-14-3487 - 3489
25 cm / 9 7/8"
oval, mit Hohlheft
oval, with hollow handle
ovalada, con mango hueco
ovale, avec manche creux
ovala, con manico vuoto



Scharfe Löffel

Bone Curettes
Cucharillas cortantes
Curettes tranchantes
Curette taglienti

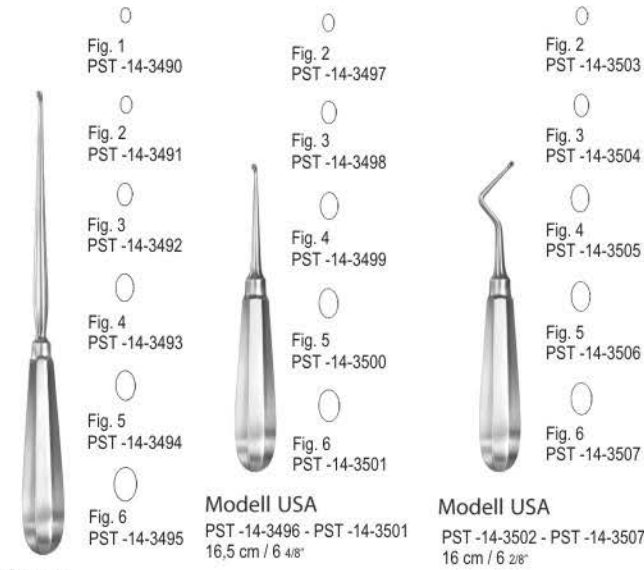

Simon

PST-14-3490 - PST-15-3095
22,5 cm / 8 7/8"

oval, mit Hohlheft
oval, with hollow handle
ovalada, con mango hueco

ovale, avec manche creux
ovale, con manico vuoto

Scharfe Löffel

Bone Curettes
Cucharillas cortantes
Curettes tranchantes
Curette taglienti

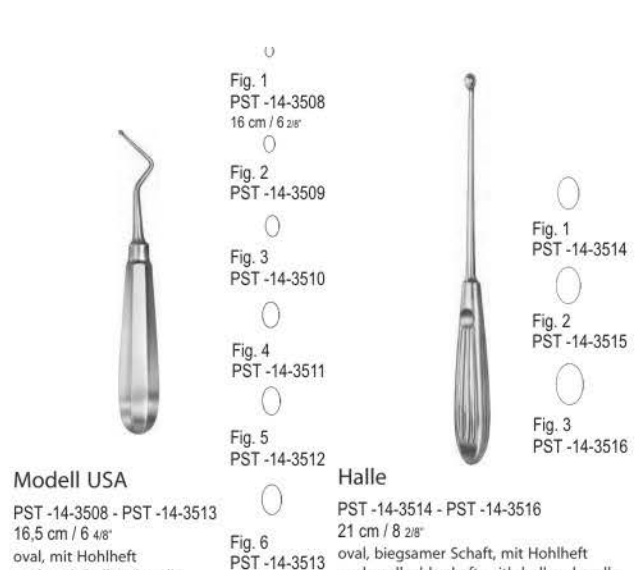

Modell USA

PST-14-3508 - PST-14-3513
16,5 cm / 6 4/8"
oval, mit Hohlheft
oval, with hollow handle
ovalada, con mango hueco
ovale, avec manche creux
ovale, con manico vuoto

Halle

PST-14-3514 - PST-14-3516
21 cm / 8 2/8"
oval, biegsamer Schaft, mit Hohlheft
oval, malleable shaft, with hollow handle
ovalada, vástago maleable, con mango hueco
ovale, tige malléable, avec manche creux
ovale, gambo malleable, con manico vuoto



Scharfe Doppellöffel

Bone Curettes, double-ended
Cucharillas de doble extremo
Curettes doubles
Curette doppie

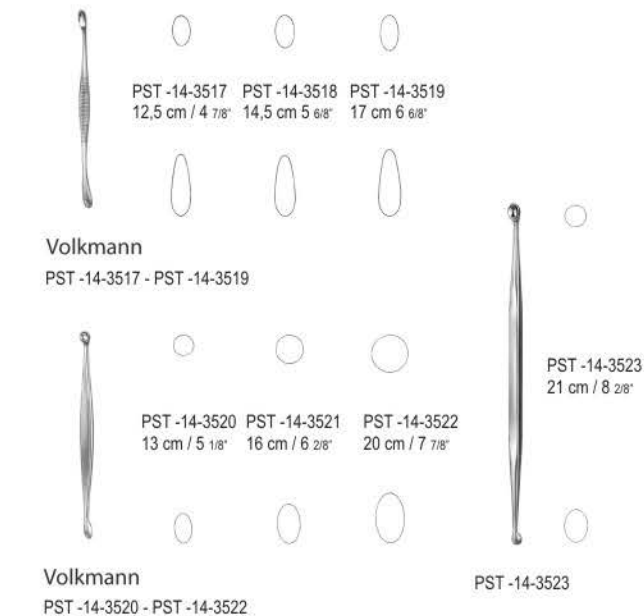

Scharfe Doppellöffel

Bone Curettes, double-ended
Cucharillas de doble extremo
Curettes doubles
Curette doppie

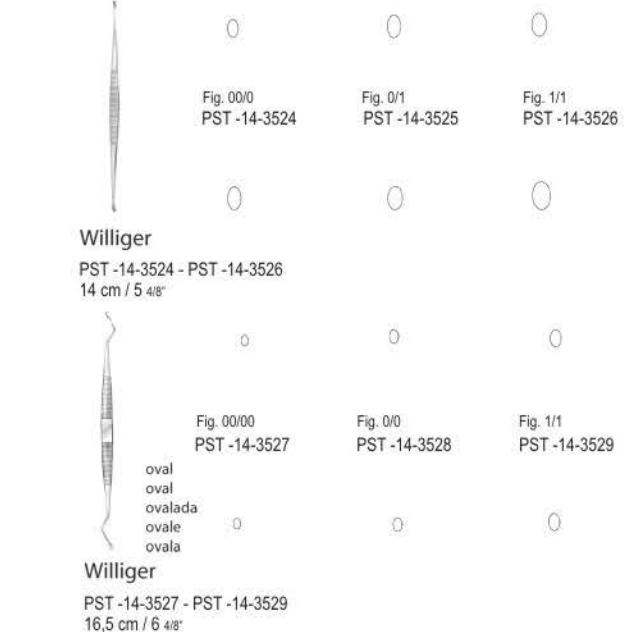

Knochenchirurgie

Bone Surgery
Cirugía ósea
Chirurgie osseuse
Chirurgie ossea

14



Quality Instruments

Scharfe Küretten

Bone Curettes
Curetas cortantes
Curettes
Curette

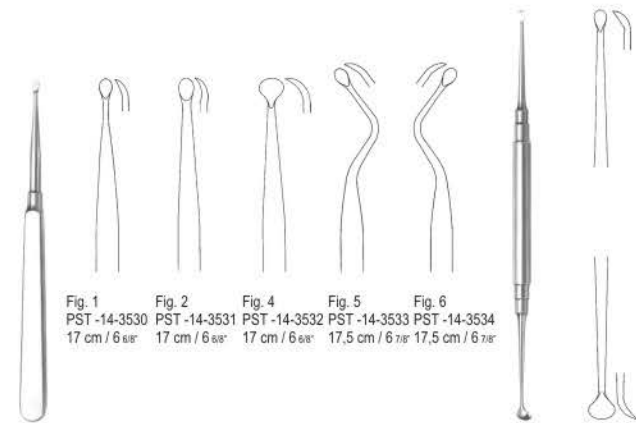

Fig. 1 PST-14-3530 17 cm / 6 5/8"
Fig. 2 PST-14-3531 17 cm / 6 5/8"
Fig. 4 PST-14-3532 17 cm / 6 5/8"
Fig. 5 PST-14-3533 17,5 cm / 6 7/8"
Fig. 6 PST-14-3534 17,5 cm / 6 7/8"

Molt
PST-14-3530 - PST-14-3534

Molt
PST-14-3535
19 cm / 7 4/8"

Raspatorien

Periosteal Elevators
Periostótomos
Rugines-raspatoires
Periostotomi

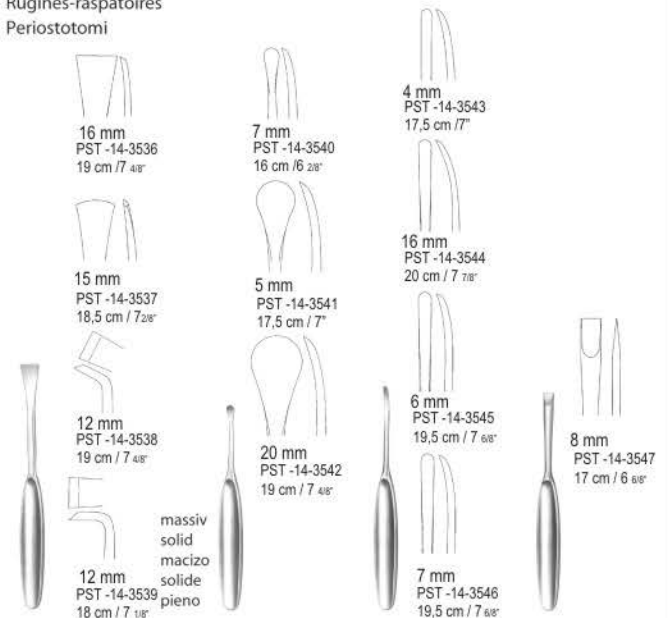

Martin-Langenbeck PST-14-3536 - 3539
Martin-Hoen PST-14-3540 3542
Martin-Cushing PST-14-3543 3546
Martin-Cushing PST-14-3547

Raspatorien

Periosteal Elevators
Periostótomos
Rugines-raspatoires
Periostotomi

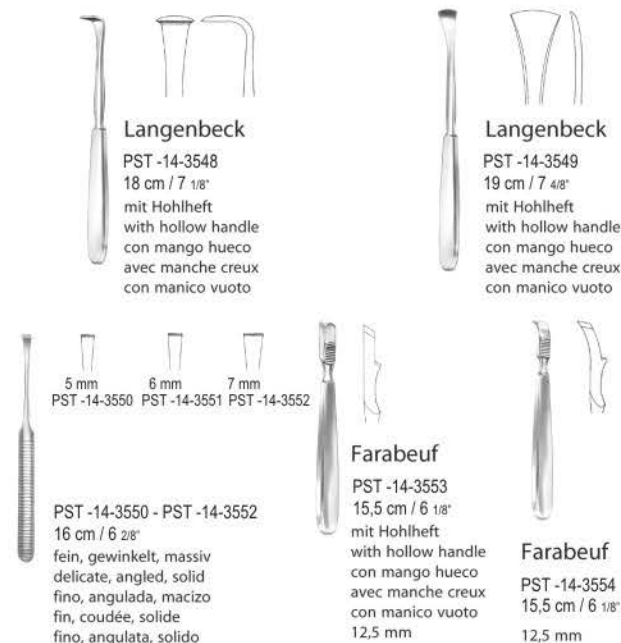

Langenbeck

PST-14-3548
18 cm / 7 1/8"
mit Hohlheft
with hollow handle
con mango hueco
avec manche creux
con manico vuoto

Langenbeck

PST-14-3549
19 cm / 7 4/8"
mit Hohlheft
with hollow handle
con mango hueco
avec manche creux
con manico vuoto

Farabeuf

PST-14-3553
15,5 cm / 6 1/8"
mit Hohlheft
with hollow handle
con mango hueco
avec manche creux
con manico vuoto
12,5 mm

Farabeuf

PST-14-3554
15,5 cm / 6 1/8"
12,5 mm

Raspatorien

Periosteal Elevators
Periostótomos
Rugines-raspatoires
Periostotomi

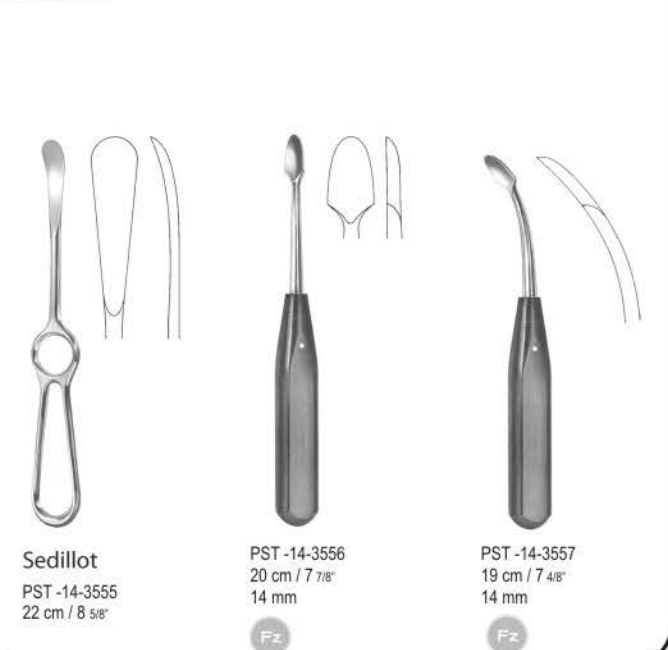

Sedillot

PST-14-3555
22 cm / 8 5/8"

PST-14-3556

20 cm / 7 7/8"
14 mm

PST-14-3557

19 cm / 7 4/8"
14 mm

Knochenchirurgie

Bone Surgery
Cirugía ósea
Chirurgie osseuse
Chirurgie ossea

14



Quality Instruments

Raspatorien

Periosteal Elevators
Periostótomos
Rugines-raspatoires
Periostotomi

massiv
solid
macizo
solide
pieno
6 mm

PST -14-3558
18 cm / 7 1/8"
6 mm

PST -14-3559
18 cm / 7 1/8"
6 mm

Williger
PST -14-3560
12,5 cm / 4 7/8"

PST -14-3561
18 cm / 7 1/8"
3 mm

massiv
solid
macizo
solide
pieno

4 mm
PST -14-3562
16,5 cm / 6 4/8"

5 mm
PST -14-3563
16,5 cm / 6 4/8"

Kahre-Williger
PST -14-3562 - PST -14-3563
16,5 cm / 6 4/8"

Williger
PST -14-3564
16 cm / 6 4/8"
7 mm

Williger
PST -14-3565
16 cm / 6 4/8"
5 mm

Raspatorien

Periosteal Elevators
Periostótomos
Rugines-raspatoires
Periostotomi

6 mm
PST -14-3567

8 mm
PST -14-3568

PST -14-3566
18 cm / 7 1/8"
20 mm

PST -14-3567 - PST -14-3568
17 cm / 6 5/8"
mit Hohlheft
with hollow handle
con mango hueco
avec manche creux
con manico vuoto

PST -14-3569

PST -14-3570

PST -14-3571
rechts gebogen
right curved
curvo a la derecha
courbé à droite
curvo destro

PST -14-3572
links gebogen
left curved
curvo a la izquierda
courbé à gauche
curvo sinistro

Doyen
PST -14-3569-3572
17,5 cm / 7"

für Erwachsene
for adults
para adultos
pour adultes
per adulti

für Kinder
for children
para niños
pour enfants
per bambini

Rippenraspatorien, mit Hohlheft
Rib Raspatories, with hollow handle
Legras costales, con mango hueco
Rugines pour le périoste costale, avec manche creux
Periostotomi costali, con manico vuoto



Raspatorien

Periosteal Elevators
Periostótomos
Rugines-raspatoires
Periostotomi

Fig. 1
PST -14-3574

Fig. 2
PST -14-3575

PST -14-3579
10 mm

PST -14-3580
15 mm

Fig. 3
PST -14-3576

Fig. 4
PST -14-3577

PST -14-3581
20 mm

PST -14-3582
25 mm

Alexander
PST -14-3573
21 cm / 8 2/8"

Semb
PST -14-3574 - PST -14-3578
23 cm / 9"
15 mm

Lambotte
PST -14-3579 - PST -14-3582
21,5 cm / 8 4/8"

Knochenfeilen

Bone Files
Limas para huesos
Limes à os
Lime per ossa

PST -14-3583
28 cm / 11"
halbrund, mit Hohlheft
semi round, with hollow handle
semi-redonda, con mango hueco
semi-ronde, avec manche creux
semi-rotonda, con manico vuoto

PST -14-3584
25 cm / 9 7/8"
halbrund, mit Hohlheft
semi round, with hollow handle
semi-redonda, con mango hueco
semi-ronde, avec manche creux
semi-rotonda, con manico vuoto

PST -14-3585
22 cm / 8 5/8"
flach, massiv
flat, massiv
plana, maciza
plate, solide
plana, solida



Knochenchirurgie

Bone Surgery
Cirugía ósea
Chirurgie osseuse
Chirurgia ossea

14



Quality Instruments

Elevatorien, Knochenfeilen

Elevators, Bone Files
Elevadores, Limas para huesos
Elévateurs, Limes à os
Elevatori, Lime per ossa

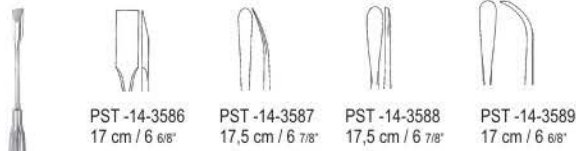

PST -14-3586 17 cm / 6 5/8"
PST -14-3587 17,5 cm / 6 7/8"
PST -14-3588 17,5 cm / 6 7/8"
PST -14-3589 17 cm / 6 5/8"

Adson

PST -14-3586 - PST -14-3589
17 cm / 6 5/8"

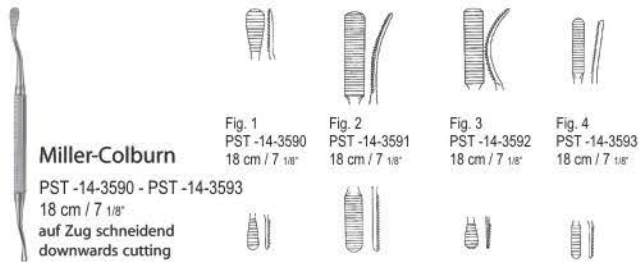

Miller-Colburn

PST -14-3590 - PST -14-3593
18 cm / 7 1/8"

auf Zug schneidend
downwards cutting
corte abajo
tranchant en bas
tagliante in basso

Fig. 1 PST -14-3590 18 cm / 7 1/8"
Fig. 2 PST -14-3591 18 cm / 7 1/8"
Fig. 3 PST -14-3592 18 cm / 7 1/8"
Fig. 4 PST -14-3593 18 cm / 7 1/8"

Knochenfeilen

Bone Files
Limas para huesos
Limes à os
Lime per ossa

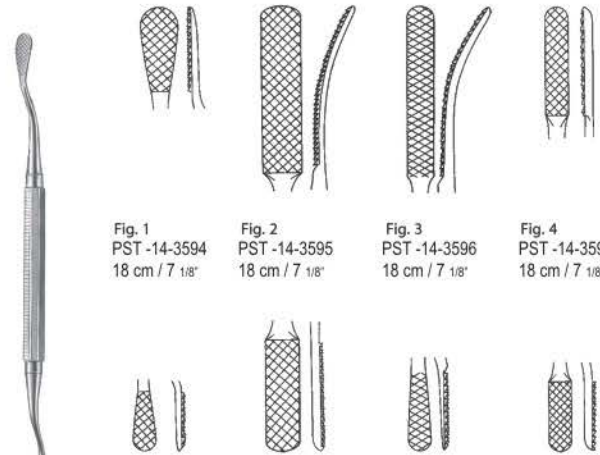

Fig. 1 PST -14-3594 18 cm / 7 1/8"
Fig. 2 PST -14-3595 18 cm / 7 1/8"
Fig. 3 PST -14-3596 18 cm / 7 1/8"
Fig. 4 PST -14-3597 18 cm / 7 1/8"

Miller-Colburn

PST -14-3594 - PST -14-3597
18 cm / 7 1/8"

Kreuzhieb
cross cut
picado en cruz
taille croisée
tagliante a croce

Elevatorien

Elevators
Elevadores
Elévateurs
Elevatori

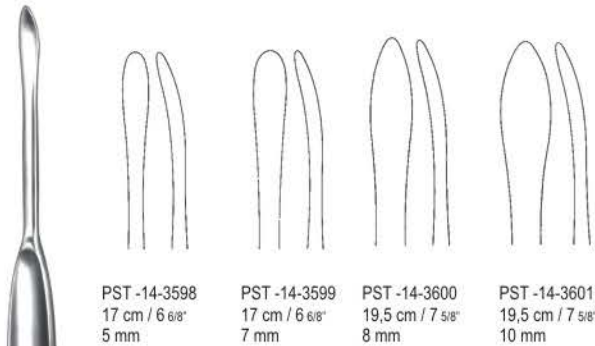

PST -14-3598 17 cm / 6 5/8" 5 mm
PST -14-3599 17 cm / 6 5/8" 7 mm
PST -14-3600 19,5 cm / 7 5/8" 8 mm
PST -14-3601 19,5 cm / 7 5/8" 10 mm

Martin-Langenbeck

PST -14-3598 - PST -14-3601
17 cm / 6 5/8"

massiv
solid
macizo
solide
pieno

Elevatorien

Elevators
Elevadores
Elévateurs
Elevatori

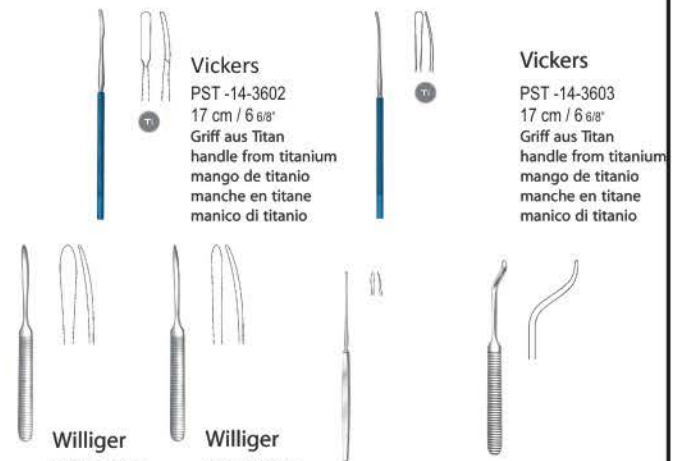

Vickers

PST -14-3602
17 cm / 6 5/8"
Griff aus Titan
handle from titanium
mango de titanio
manche en titane
manico di titanio

Vickers

PST -14-3603
17 cm / 6 5/8"
Griff aus Titan
handle from titanium
mango de titanio
manche en titane
manico di titanio

Williger

PST -14-3604
17 cm / 6 5/8"
massiv
solid
macizo
solide
pieno
7 mm

Williger

PST -14-3605
16 cm / 6 2/8"
massiv
solid
macizo
solide
pieno
4 mm

PST -14-3606
16 cm / 6 2/8"
Mikroelelevatorium
Micro Elevator
Micro Elevador
Micro-Élévateur
Micro Elevatorio

PST -14-3607
16 cm / 6 2/8"
Phalangenhebel
Phalangeal Elevator
Elevador para falanges
Elévateur pour phalanges
Divaricatore per falanghe

Knochenchirurgie

Bone Surgery
Cirugía ósea
Chirurgie osseuse
Chirurgie ossea

14



Quality Instruments

Doppeldissektoren

Dissectors, double-ended
Disectores dobles
Dissecteurs doubles
Dissettori doppi



Alderdyce

PST -14-3608
21 cm / 8 2/8"

McDonald

PST -14-3609
18,5 cm / 7 2/8"

Knochenhebel

Bone Levers
Elevadores para hueso
Leviers à os
Elevatori per ossa



PST -14-3610
16 cm / 6 2/8"

Hohmann, mini
PST -14-3611 - PST -14-3612
16 cm / 6 2/8"



PST -14-3613
15 cm / 5 7/8"
15 mm



Hohmann, mini
PST -14-3614
16 cm / 6 2/8"
15 mm

Knochenhebel

Bone Levers
Elevadores para hueso
Leviers à os
Elevatori per ossa



Hohmann

PST -14-3615
21,5 cm / 8 4/8"
schmale Spitze
narrow tip
punta estrecha
pointe étroite
punta stretta
8 mm

Hohmann

PST -14-3616
23,5 cm / 9 2/8"
schmale Spitze
narrow tip
punta estrecha
pointe étroite
punta stretta
18 mm

Hohmann

PST -14-3617
23,5 cm / 9 2/8"
schmale Spitze
narrow tip
punta estrecha
pointe étroite
punta stretta
43 mm

Knochenhebel

Bone Levers
Elevadores para hueso
Leviers à os
Elevatori per ossa

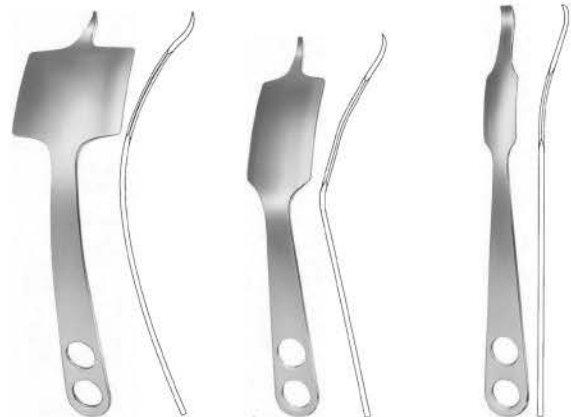

Hohmann

PST -14-3618
25 cm / 9 7/8"
schmale Spitze
narrow tip
punta estrecha
pointe étroite
punta stretta
70 mm

Hohmann

PST -14-3619
23,5 cm / 9 2/8"
schmale Spitze
narrow tip
punta estrecha
pointe étroite
punta stretta
43 mm

Hohmann

PST -14-3620
25,5 cm / 10"
breite Spitze
wide tip
punta ancha
pointe large
punta larga
22 mm



Knochenchirurgie

Bone Surgery
Cirugía ósea
Chirurgie osseuse
Chirurgie ossea

14



Quality Instruments

Knochenheber

Bone Levers
Elevadores para hueso
Leviers à os
Elevatori per ossa



Hohmann
PST -14-3621
29 cm / 11 3/8"
breite Spitze
wide tip
punta ancha
pointe large
punta larga
35 mm

Hohmann
PST -14-3622
27,5 cm / 10 7/8"
breites, rundes Ende
wide, round tip
punta ancha, redonda
pointe large, ronde
punta larga, rotonda
24 mm

Lange-Hohmann
PST -14-3623
25 cm / 9 7/8"
breite Spitze mit Längsrille
wide tip with groove
punta ancha con ranura
pointe large avec rainure
punta larga con scanallatura
22 mm

Knochenheber

Bone Levers
Elevadores para hueso
Leviers à os
Elevatori per ossa

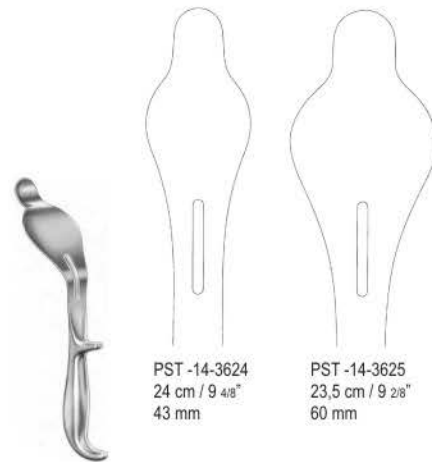

PST -14-3624
24 cm / 9 4/8"
43 mm

PST -14-3625
23,5 cm / 9 2/8"
60 mm

Bennett
PST -14-3624 - PST -14-3625
24 cm / 9 4/8"



Kniehaken, Spinalhaken

Knee Retractors, Spinal Retractors
Separadores para rodilla, Separadores espinales
Ecarteurs pour le genou, Ecarteurs spinaux
Divaricatori per il ginocchio, Divaricatori spinali



Blount
PST -14-3626
26,5 cm / 10 3/8"
stumpf
blunt
romo
mousse
smusso
39 mm

Blount
PST -14-3627
26,5 cm / 10 3/8"
47 mm

PST -14-3629
16 cm / 6 2/8"
95 x 30 mm

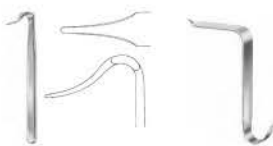

Blount
PST -14-3628
17,5 cm / 6 7/8"

Taylor
PST -14-3629 - PST -14-3630
16 cm / 6 2/8"



Meniskotome, Meniskusmesser

Meniscus Knives
Cuchillos para menisco
Bistouris à ménisque
Meniscotomi

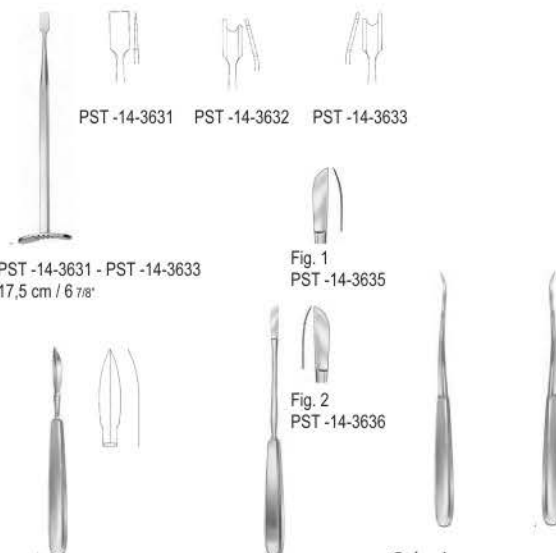

PST -14-3631 **PST -14-3632** **PST -14-3633**

PST -14-3631 - PST -14-3633
17,5 cm / 6 7/8"

Fig. 1
PST -14-3635

Fig. 2
PST -14-3636

PST -14-3634
17,5 cm / 6 7/8"

Neff
PST -14-3635 - PST -14-3636
22 cm / 8 5/8"

Salenius
PST -14-3637
21,5 cm / 8 4/8"

Salenius
PST -14-3638
21,5 cm / 8 4/8"





Sehnenstripper

Tendon Strippers
Enucleadores de tendones
Instruments à écorcher les tendons
Scollatendini

Fig. 1
PST -14-3639
15 cm / 5 7/8"

Fig. 2
PST -14-3640
15 cm / 5 7/8"

Fig. 3
PST -14-3641
15 cm / 5 7/8"

Fig. 4
PST -14-3642
15 cm / 5 7/8"

PST -14-3643
23 cm / 9"
Ø 4 mm

PST -14-3644
23 cm / 9"
Ø 4,5 mm

PST -14-3645
23 cm / 9"
Ø 5,5 mm

PST -14-3646
Schraube
Screw
Tornillo
Vis
Vite



biegsam
malleable
maleable
malleabile

Bunnell

PST -14-3639 - PST -14-3642
15 cm / 5 7/8"

PST -14-3643 - PST -14-3645
23 cm / 9"

flexibler Schaft
flexible shaft
vástago flexible
tige flexible
gambo flessibile

PST -14-3646
23 cm / 9"

Fischer

PST -14-3647
31 cm / 12 2/8"
stumpf
blunt
romo
mousse
smusso

PST -14-3648
28,5 cm / 11 2/8"

Bunnell

PST -14-3649
23 cm / 9"
Sehnedurchzugs-
sonde
Tendon Passer
Sonda conductora de tendones
Sonde conductrice pour tendons
Sonda conduttrice per tendini



Sehnenfazzangen, Sehnedurchzugzangen

Tendon Holding Forceps, Tendon Tunnelling Forceps
Pinzas para coger tendones, Pinzas para pasar tendones
Pincers pour saisir les tendons, Pincers pour passer les tendons
Pinze per afferrare tendini, Pinze passa-tendini



PST -14-3651 PST -14-3652 PST -14-3653
15 cm / 5 7/8" 19 cm / 7 4/8" 24,5 cm / 9 5/8"



Steinmann
PST -14-3650
16 cm / 6 2/8"

Brand
PST -14-3651 - PST -14-3653



PST -14-3654
21 cm / 8 2/8"

PST -14-3655
20,5 cm / 8 1/8"

Carroll
PST -14-3656
11,5 cm / 4 4/8"

PST -14-3654 - PST -14-3655

Sehnenfazzangen, Sehneinflecht-klemmen

Tendon Holding Forceps, Tendon Interlacing Forceps
Pinzas para coger tendones, Pinzas para entrelazar tendones
Pincers pour saisir les tendons, Pincers pour entrelacer les tendons
Pinze per afferrare tendini, Pinze per allacciare tendini



PST -14-3657
11,5 cm / 4 4/8"

Kleinert-Kutz

PST -14-3658
21 cm / 8 2/8"
Schaftlänge
shaft length
longitud del vástago
longueur de la tige
lunghezza dell'asta
140 mm

PST -14-3659
15 cm / 5 7/8"



PST -14-3660
15 cm / 5 7/8"

PST -14-3661
14,5 cm / 5 6/8"
Knochenhaltzangen
Bone Holding Forceps
Pinzas para hueso
Daviers porte-os
Tenaglie per ossa



Knochenchirurgie

Bone Surgery
Cirugía ósea
Chirurgie osseuse
Chirurgie ossea

14



Quality Instruments

Knorpelfasszangen

Cartilage Seizing Forceps
Pinzas para cartilago
Pincers à cartilage
Pinze per cartilagine



PST -14-3662
18,5 cm / 7 2/8"



PST -14-3663
21 cm / 8 2/8"
gerade
straight
recta
droite
diritta



Bircher-Ganske
PST -14-3662 - PST -14-3663



Bircher-Ganske
PST -14-3664
20 cm / 7 7/8"

seitwärts gebogen
curved sideways
curva lateralmente
courbée latéralement
curva lateralmente



Dingmann
PST -14-3665
20,5 cm / 8 1/8"

aufgebogen
curved upwards
curva por arriba
courbée en haut
curva in alto

Knorpelfasszangen, Repositionszangen, Knochenhaltezangen

Cartilage Seizing Forceps, Reposition Forceps, Bone Holding Forceps
Pinzas para cartilago, Pinzas para reposición, Pinzas para hueso
Pincers à cartilage, Pincers à réduction, Daviers porte-os
Pinze per cartilagine, Pinze per riposizioni, Tenaglie per ossa



Martin
PST -14-3666
18,5 cm / 7 2/8"



PST -14-3669
14 cm / 5 4/8"
grazil
delicate
delicada
gracile
sottile



PST -14-3667
13,5 cm / 5 3/8"
lange Sperre
long ratchet
cremallera larga
cremallière longue
cremagliera lunga



PST -14-3670
9 cm / 3 4/8"
lange Sperre
long ratchet
cremallera larga
cremallière longue
cremagliera lunga



Lewin
PST -14-3668
18 cm / 7 1/8"

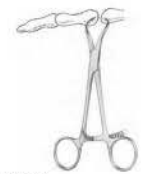

PST -14-3671
15 cm / 5 7/8"
lange Sperre
long ratchet
cremallera larga
cremallière longue
cremagliera lunga

Knochenhaltezangen

Bone Holding Forceps
Pinzas para hueso
Daviers porte-os
Tenaglie per ossa



Langenbeck
PST -14-3672
21 cm / 8 2/8"

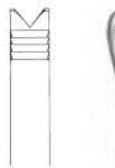

Fergusson
PST -14-3673
21 cm / 8 2/8"
kräftiges Modell
heavy pattern
modelo fuerte
modèle fort
modello forte

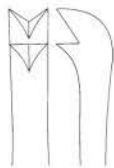

Frosch
PST -14-3674
18 cm / 7 1/8"

Knochenhaltezangen, Repositionszangen

Bone Holding Forceps, Reposition Forceps
Pinzas para hueso, Pinzas para reposición
Daviers porte-os, Pincers à réduction
Tenaglie per ossa, Pinze per riposizioni



PST -14-3675
20 cm / 7 7/8"



PST -14-3676
17,5 cm / 6 7/8"
mit Gewindesperre
with thread fixation
con cremallera de rosca
avec cremallière fileté
con cremagliera a filettatura



PST -14-3677
24 cm / 9 4/8"
mit Gewindesperre
with thread fixation
con cremallera de rosca
avec cremallière fileté
con cremagliera a filettatura

Knochenchirurgie

Bone Surgery
Cirugía ósea
Chirurgie osseuse
Chirurgie ossea

14



Quality Instruments

Knochenhaltezaugen, Repositionszaugen

Bone Holding Forceps, Reposition Forceps
Pinzas para hueso, Pinzas para reposición
Daviers porte-os, Pincas à réduction
Tenaglie per ossa, Pinze per riposizioni



PST -14-3678 17 cm / 6 5/8"
PST -14-3679 21 cm / 1/8"

Kern
PST -14-3678 - PST -14-3679

Semb
PST -14-3680
19,5 cm / 7 5/8"
seitwärts gebogen
curved sideways
curva lateralmente
courbée latéralement
curva lateralmente



Knochenhaltezaugen

Bone Holding Forceps
Pinzas para hueso
Daviers porte-os
Tenaglie per ossa

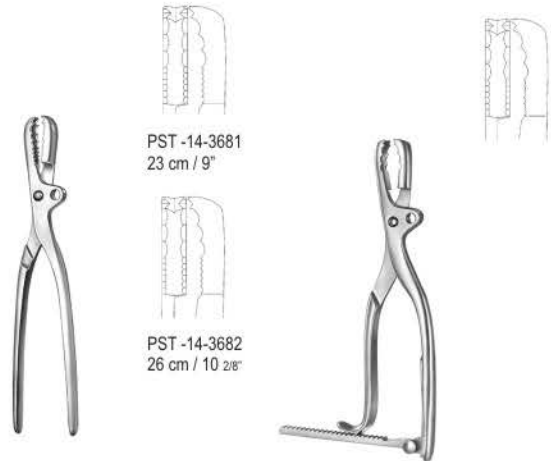

PST -14-3681
23 cm / 9"

PST -14-3682
26 cm / 10 2/8"

Farabeuf
PST -14-3681 - PST -14-3682

Farabeuf
PST -14-3683
26 cm / 10 2/8"



Knochenhaltezaugen

Bone Holding Forceps
Pinzas para hueso
Daviers porte-os
Tenaglie per ossa

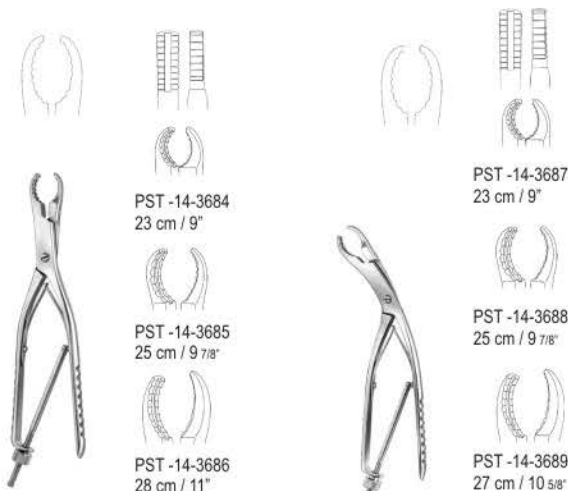

PST -14-3684
23 cm / 9"

PST -14-3685
25 cm / 9 7/8"

PST -14-3686
28 cm / 11"

PST -14-3687
23 cm / 9"

PST -14-3688
25 cm / 9 7/8"

PST -14-3689
27 cm / 10 5/8"

Ulrich
PST -14-3684 - PST -14-3686
mit Gewindesperre
with thread fixation
con cremallera de rosca
avec cremallière fileté
con cremagliera a filettatura

Ulrich
PST -14-3687 - PST -14-3689
mit Gewindesperre
with thread fixation
con cremallera de rosca
avec cremallière fileté
con cremagliera a filettatura



Knochenhaltezaugen

Bone Holding Forceps
Pinzas para hueso
Daviers porte-os
Tenaglie per ossa

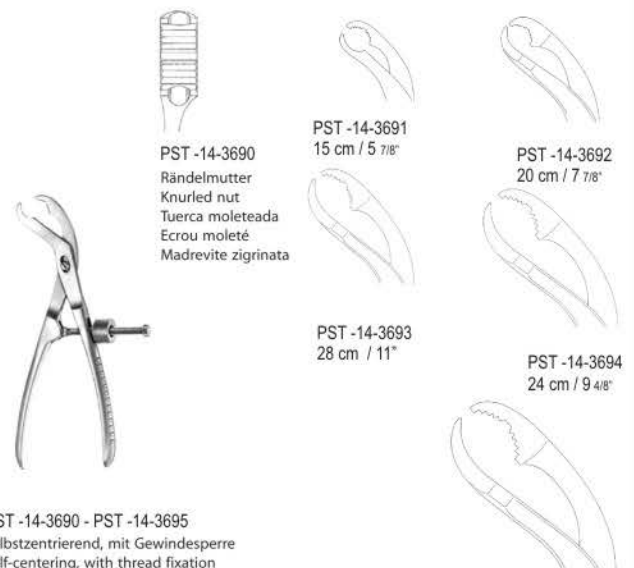

PST -14-3690
Rändelmutter
Knurled nut
Tuerca moleteada
Ecrou moleté
Madrevite zigrinata

PST -14-3691
15 cm / 5 7/8"

PST -14-3692
20 cm / 7 7/8"

PST -14-3693
28 cm / 11"

PST -14-3694
24 cm / 9 4/8"

PST -14-3690 - PST -14-3695
selbstzentrierend, mit Gewindesperre
self-centering, with thread fixation
autocentrante, con cremallera de rosca
à centrage automatique, avec cremallière fileté
centraggio automatico, con cremagliera a filettatura

PST -14-3695
26 cm / 10 2/8"



Knochenchirurgie

Bone Surgery
Cirugía ósea
Chirurgie osseuse
Chirurgie ossea

14



Quality Instruments

Knochenhaltezzangen

Bone Holding Forceps
Pinzas para hueso
Daviers porte-os
Tenaglie per ossa



Lane
PST -14-3696
33 cm / 13"

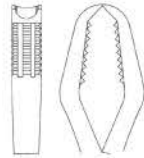

PST -14-3696
ohne Sperre
without ratchet
sin cremallera
sans cremallière
senza cremagliera

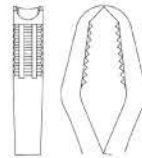

PST -14-3697
mit Sperre
with ratchet
con cremallera
avec cremallière
con cremagliera

Knochenhaltezzangen

Bone Holding Forceps
Pinzas para hueso
Daviers porte-os
Tenaglie per ossa



Verbrugge
PST -14-3698 - PST -14-3700



PST -14-3698
25 cm / 9 7/8"



PST -14-3699
26 cm / 10 2/8"

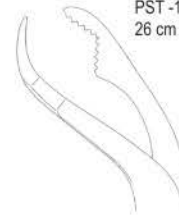

PST -14-3700
27,5 cm / 10 7/8"



Knochenhaltezzangen, Amputationsschild

Bone Holding Forceps, Amputation Retractor
Pinzas para hueso, Retractor para amputación
Daviers porte-os, Retracteur pour amputation
Tenaglie per ossa, Retrattore per amputazione



Verbrugge
PST -14-3701
17,5 cm / 6 7/8"

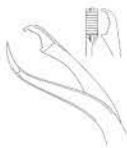

Percy
PST -14-3702
auseinandernehmbar
detachable
desmontable
démontable
smontabile



Hohlmeißelzangen

Bone Rongeurs
Pinzas gubias
Pincen-gouges
Pinze-sgorbie



Stellbrink
PST -14-3703 - PST -14-3704

PST -14-3703
17 cm / 6 6/8"

PST -14-3704
16,5 cm / 6 4/8"



Friedmann
PST -14-3705
12,5 cm / 4 7/8"



Friedmann
PST -14-3706
13,5 cm / 5 3/8"



Friedmann
PST -14-3707
13,5 cm / 5 3/8"



Cleveland
PST -14-3708
13,5 cm / 5 3/8"





Hohlmeißelzangen

Bone Rongeurs
Pinzas gubias
Pincès-gouges
Pinze-sgorbie



Cleveland
PST -14-3709
16,5 cm / 6 4/8"



Mead
PST -14-3710
16,5 cm / 6 4/8"



Hartmann
PST -14-3711
17,5 cm / 6 7/8"



Jansen
PST -14-3712 - PST -14-3713
18 cm / 7 1/8"

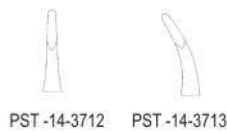

Lempert
PST -14-3714
19 cm / 7 4/8"



Hohlmeißelzangen

Bone Rongeurs
Pinzas gubias
Pincès-gouges
Pinze-sgorbie



PST -14-3715
14,5 cm / 5 6/8"



PST -14-3716
15,5 cm / 6 1/8"



PST -14-3717
15,5 cm / 6 1/8"



PST -14-3718
14,5 cm / 5 6/8"



Blumenthal
PST -14-3719 - PST -14-3721



Hohlmeißelzangen

Bone Rongeurs
Pinzas gubias
Pincès-gouges
Pinze-sgorbie



Luer
PST -14-3722 - PST -14-3723
18,5 cm / 7 2/8"



Luer
PST -14-3724 - PST -14-3726
14,5 cm / 5 6/8"



Böhler
PST -14-3727 - PST -14-3728
15 cm / 5 7/8"



Beyer
PST -14-3729
18 cm / 7 1/8"



Hohlmeißelzangen

Bone Rongeurs
Pinzas gubias
Pincès-gouges
Pinze-sgorbie



Zaufal-Jansen
PST -14-3730
18 cm / 7 1/8"



Mayfield
PST -14-3731
18 cm / 7 1/8"



Marquard
PST -14-3732
20,5 cm / 8 1/8"



Ruskin
PST -14-3733
19 cm / 7 4/8"



Ruskin
PST -14-3734
24 cm / 9 4/8"



Knochenchirurgie

Bone Surgery
Cirugía ósea
Chirurgie osseuse
Chirurgie ossea

14



Quality Instruments

Hohlmeißelzangen

Bone Rongeurs
Pinzas gubias
Pincers-gouges
Pinze-sgorbie



Semb

PST -14-3735
23,5 cm / 9 2/8"



Stille

PST -14-3736
22,5 cm / 8 7/8"



Hohlmeißelzangen

Bone Rongeurs
Pinzas gubias
Pincers-gouges
Pinze-sgorbie



Echlin

PST -14-3737 - PST -14-3739
23 cm / 9"



PST -14-3737



PST -14-3738



PST -14-3739



Stille-Ruskin

PST -14-3740
23,5 cm / 9" 2/8"



Hohlmeißelzangen

Bone Rongeurs
Pinzas gubias
Pincers-gouges
Pinze-sgorbie



Leksell-Stille

PST -14-3741 - PST -14-3742
24,5 cm / 9 5/8"

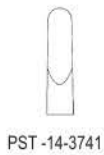

PST -14-3741



PST -14-3742



Frykholm

PST -14-3743
24,5 cm / 9 5/8"



Hohlmeißelzangen

Bone Rongeurs
Pinzas gubias
Pincers-gouges
Pinze-sgorbie



Stille-Luer

PST -14-3744 - PST -14-3745
22,5 cm / 8 7/8"



PST -14-3744



PST -14-3745



Stille-Luer

PST -14-3746 - PST -14-3749



PST -14-3746
23 cm / 9"



PST -14-3747
23 cm / 9"

PST -14-3748
27 cm / 10 5/8"

PST -14-3749
27 cm / 10 5/8"

Knochenchirurgie

Bone Surgery
Cirugía ósea
Chirurgie osseuse
Chirurgie ossea

14



Quality Instruments

Hohlmeißelzangen

Bone Rongeurs
Pinzas gubias
Pinces-gouges
Pinze-sgorbie



Sauerbruch
PST -14-3750 - PST -14-3751
31 cm / 12 2/8"



PST -14-3750



PST -14-3751



Knochensplitterzangen

Bone Cutting Forceps
Pinzas cortantes para hueso
Pinces coupantes à os
Cesoie per ossa



Cottle-Kazanjian
PST -14-3752
19 cm / 7 4/8"



PST -14-3752



Liston
PST -14-3753 - PST -14-3756
14 cm / 5 4/8"



PST -14-3753
14 cm / 5 4/8"



PST -14-3754
17 cm / 6 6/8"



PST -14-3755
20 cm / 7 7/8"



PST -14-3756
22 cm / 8 5/8"



Liston
PST -14-3757 - PST -14-3760
14 cm / 5 4/8"



PST -14-3757
14 cm / 5 4/8"



PST -14-3758
17 cm / 6 6/8"



PST -14-3759
20 cm / 7 7/8"



PST -14-3760
22 cm / 8 5/8"



Knochensplitterzangen

Bone Cutting Forceps
Pinzas cortantes para hueso
Pinces coupantes à os
Cesoie per ossa



Cleveland
PST -14-3761
17 cm / 6 6/8"



Cleveland
PST -14-3762
14,5 cm / 5 6/8"



Böhler
PST -14-3763
14,5 cm / 5 6/8"



Böhler
PST -14-3764
14,5 cm / 5 6/8"



Cleveland
PST -14-3765
17 cm / 6 6/8"



Knochensplitterzangen

Bone Cutting Forceps
Pinzas cortantes para hueso
Pinces coupantes à os
Cesoie per ossa



Ruskin-Liston
PST -14-3766 - PST -14-3767

PST -14-3766
19 cm / 7 4/8"

PST -14-3767
18,5 cm / 7 2/8"



Stille-Liston
PST -14-3768
26 cm / 10 2/8"



Knochenchirurgie

Bone Surgery
Cirugía ósea
Chirurgie osseuse
Chirurgie ossea

14



Quality Instruments

Knochensplitterzangen

Bone Cutting Forceps
Pinzas cortantes para hueso
Pincès coupantes à os
Cesoie per ossa

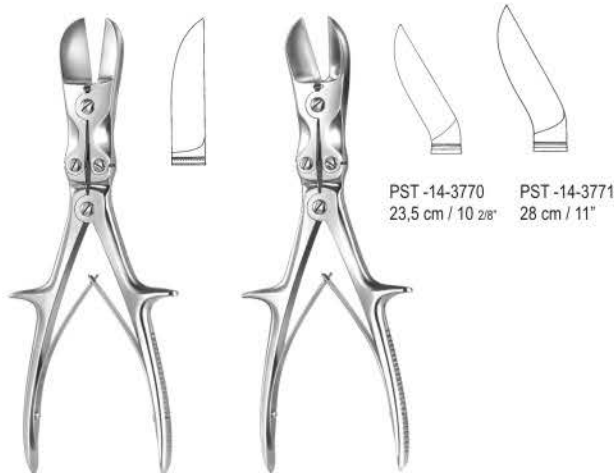

Stille-Liston
PST -14-3769
28 cm / 11"

Stille-Liston
PST -14-3770 - PST -14-3771

PST -14-3770 23,5 cm / 10 2/8"
PST -14-3771 28 cm / 11"

Knochensplitterzangen

Bone Cutting Forceps
Pinzas cortantes para hueso
Pincès coupantes à os
Cesoie per ossa

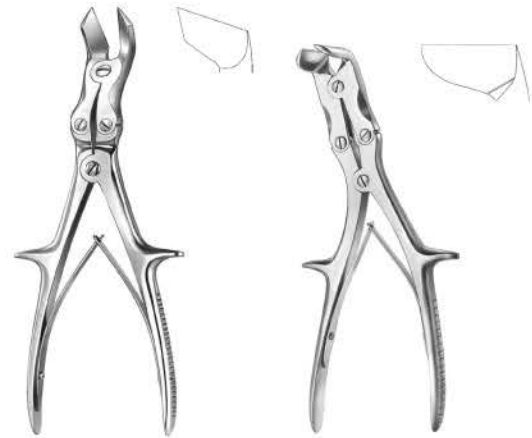

Liston-Key
PST -14-3772
26 cm / 10 2/8"

Semb
PST -14-3773
24,5 cm / 9 5/8"

Bleihände

Lead Hands
Manoplas de plomo
Mains en plomb
Mani di piombo



PST -14-3776
24 x 3 mm
Silikonring, klein, autoklavierbar
Silicon ring, small, autoclavable
Arandela de silicona, pequeña, autoclavable
Anneau en silicone, petit, stérilisable à l'autoclave
Anello in silicone, piccolo, sterilizzabile in autoclave

PST -14-3777
27 x 3 mm
Silikonring, mittel, autoklavierbar
Silicon ring, medium, autoclavable
Arandela de silicona, mediana, autoclavable
Anneau en silicone, moyen, stérilisable à l'autoclave
Anello in silicone, medio, sterilizzabile in autoclave

PST -14-3774
für Kinder
for children
para niños
pour enfants
per bambini

PST -14-3775
für Erwachsene
for adults
para adultos
pour adultes
per adulti

PST -14-3778
34 x 3 mm
Silikonring, groß, autoklavierbar
Silicon ring, large, autoclavable
Arandela de silicona, grande, autoclavable
Anneau en silicone, grand, stérilisable à l'autoclave
Anello in silicone, grande, sterilizzabile in autoclave

Handhalter

Hand Restrainer
Sujetador de mano
Reteneur pour main
Fissatore per mano



Vickers
PST -14-3779

zur schnellen und sicheren Fixierung der Hand
To hold the hand quickly and efficiently in any desired position
Para mantener la mano en cualquier posición deseada, eficiente y rápidamente
Pour immobiliser de façon rapide et sûre la main dans n'importe quelle position
Per una rapida e sicura fissazione alla mano in qualsiasi posizione desiderata

Herz-und Gefäßchirurgie
Cardiovascular Surgery
Cirugia Cardiovascular
Chirurgie Cardio-vasculaire
Chirurgia Cardiovascolare



15

120 - 139

Neurochirurgie Laminektomie
Neurosurgery, Laminectomy
Neurocirugia, Laminectomia
Neurochirurgie, Laminectomie
Neurochirurgia, Laminectomia



16

140 - 145

Tracheotomiie
Tracheotomy
Traqueotomía
Trachéotomie
Trachéotomia



17

146



Rippenscheren

Rib Shears
Costótomos
Costotomes
Costotomi



ziehender Schnitt
drawing cut
corte oblicuo
lame glissante
lama di retroazione

PST-15-3801
23 cm / 9"
Knochenschere
Bone Shears
Cizallas para hueso
Cisailles à os
Cesoia per ossa

PST-15-3802
23 cm / 9"

Gluck
PST-15-3803
21 cm / 8 2/8"



Rippenscheren

Rib Shears
Costótomos
Costotomes
Costotomi



Bethune
PST-15-3804
34,5 cm / 13 5/8"

Sauerbruch
PST-15-3805
26 cm / 10 2/8"

Giertz-Stille
PST-15-3806
24,5 cm / 9 5/8"



Rippensperrer

Rib Retractors
Separadores costales
Ecarteurs des côtes
Divaricatori costali



für Säuglinge
for babies
para recién nacidos
pour nourissons
per neonati

mit 2 Paar Valven
with 2 pairs of blades
con 2 pares de valvas
avec 2 paires de valves
con 2 paia di valve

Spreizweite
spreading
apertura
ouverture
apertura

PST-15-3807 9 x 20 mm 52 mm
9 x 10 mm 52 mm

Cooley

für Säuglinge
for babies
para recién nacidos
pour nourissons
per neonati

Seitenvalven
lateral blades
hojas laterales
valves latérales
valve laterali

Spreizweite
spreading
apertura
ouverture
apertura



PST-15-3808 12 x 16 mm 95 mm

Cooley

für Kinder
for children
para niños
pour enfants
per bambini

Seitenvalven
lateral blades
hojas laterales
valves latérales
valve laterali

Spreizweite
spreading
apertura
ouverture
apertura



PST-15-3809 A 15 x 30 mm 140 mm
PST-15-3809 B 21 x 44 mm 150 mm



Rippensperrer

Rib Retractors
Separadores costales
Ecarteurs des côtes
Divaricatori costali



Cooley

für Erwachsene
for adults
para adultos
pour adultes
per adulti

Seitenvalven
lateral blades
hojas laterales
valves latérales
valve laterali

Spreizweite
spreading
apertura
ouverture
apertura

PST-15-3810 35x50 mm 200 mm



Finochietto, Infant

für Säuglinge
for babies
para recién nacidos
pour nourissons
per neonati

Seitenvalven
lateral blades
hojas laterales
valves latérales
valve laterali

Spreizweite
spreading
apertura
ouverture
apertura

PST-15-3811 15x15 mm 75 mm



Finochietto, Baby

für Kinder
for children
para niños
pour enfants
per bambini

Seitenvalven
lateral blades
hojas laterales
valves latérales
valve laterali

Spreizweite
spreading
apertura
ouverture
apertura

PST-15-3812 31x31 mm 100 mm



Herz-und
Gefäßchirurgie

Cardiovascular Surgery
Cirugia Cardiovascular
Chirurgie Cardio-vasculaire
Chirurgia Cardiovascolare

15



Quality Instruments

Rippensperrer

Rib Retractors
Separadores costales
Ecarteurs des côtes
Divaricatori costali



Finochietto

PST-15-3813
PST-15-3814
PST-15-3815

Seitenvalven lateral blades
hojas laterales
valves latérales
valve laterali

Spreizweite spreading
abertura
ouverture
apertura

40 x 45 mm 135 mm
52 x 62 mm 175 mm
85 x 65 mm 175 mm



Burford

PST-15-3816
PST-15-3817
PST-15-3818

mit 2 Paar Valven
with 2 pairs of blades
con 2 pares de valvas
avec 2 paires de valves
con 2 paia di valve

Spreizweite spreading
abertura
ouverture
apertura

47 x 62 mm + 65 x 62 mm 200 mm
47 x 62 mm + 65 x 62 mm 260 mm
47 x 62 mm + 65 x 62 mm 300 mm

Rippensperrer

Rib Retractors
Separadores costales
Ecarteurs des côtes
Divaricatori costali



Castañeda

für Säuglinge
for babies
para recién nacidos
pour nourissons
per neonati

Seitenvalven lateral blades
hojas laterales
valves latérales
valve laterali

Spreizweite spreading
abertura
ouverture
apertura

PST-15-3819 10,5 x 32 mm 65 mm



Castañeda

für Kleinkinder
for infants
para bebés
pour petits enfants
per bambini piccoli

Seitenvalven lateral blades
hojas laterales
valves latérales
valve laterali

Spreizweite spreading
abertura
ouverture
apertura

PST-15-3820 12 x 45 mm 70 mm



Castañeda

für Kleinkinder
for infants
para bebés
pour petits enfants
per bambini piccoli

Seitenvalven lateral blades
hojas laterales
valves latérales
valve laterali

Spreizweite spreading
abertura
ouverture
apertura

PST-15-3821 15 x 60 mm 120 mm

Rippensperrer

Rib Retractors
Separadores costales
Ecarteurs des côtes
Divaricatori costali



Finochietto (modif.)

Seitenvalven lateral blades
hojas laterales
valves latérales
valve laterali

Spreizweite spreading
abertura
ouverture
apertura

PST-15-3822 14 x 15 mm 120 mm



Haight

Seitenvalven lateral blades
hojas laterales
valves latérales
valve laterali

Spreizweite spreading
abertura
ouverture
apertura

PST-15-3823 30 x 30 mm 120 mm

Sternumspreizer

Sternal Retractors
Separadores esternales
Ecarteurs à sternum
Divaricatori per sterno



Morse-Favaloro

für Kinder
for children
para niños
pour enfants
per bambini

4 bewegliche Valven
4 movable blades
4 valvas móviles
4 valves mobiles
4 valve mobili

Spreizweite spreading
abertura
ouverture
apertura

PST-15-3824 17 x 22 mm 160 mm



Morse

für Erwachsene
for adults
para adultos
pour adultes
per adulti

4 bewegliche Valven
4 movable blades
4 valvas móviles
4 valves mobiles
4 valve mobili

Spreizweite spreading
abertura
ouverture
apertura

PST-15-3825 22 x 27 mm 200 mm





Rippensperrer

Rib Retractors
Separadores costales
Ecarteurs des côtes
Divaricatori costali

Tuffier



Seitenvalven
lateral blades
hojas laterales
valves latérales
valve laterali

Spreizweite
spreading
abertura
ouverture
apertura

PST-15-3826 45 x 45 mm 160 mm

Finochietto, Baby



Seitenvalven
lateral blades
hojas laterales
valves latérales
valve laterali

Spreizweite
spreading
abertura
ouverture
apertura

PST-15-3827 14 x 15 mm 75 mm

Rippensperrer

Rib Retractors
Separadores costales
Ecarteurs des côtes
Divaricatori costali



Finochietto

Seitenvalven
lateral blades
hojas laterales
valves latérales
valve laterali

Spreizweite
spreading
abertura
ouverture
apertura

PST-15-3828 30 x 45 mm 150 mm
PST-15-3829 46 x 62 mm 190 mm
PST-15-3830 80 x 65 mm 190 mm

Rippensperrer

Rib Retractors
Separadores costales
Ecarteurs des côtes
Divaricatori costali



Sperrer allein
Retractor only
Separador suelto
Ecarteur seul
Divaricatore solo

De Bakey

mit 3 Paar Valven
with 3 pairs of blades
con 3 pares de valvas
avec 3 paires de valves
con 3 paia di valve

Spreizweite
spreading
abertura
ouverture
apertura

PST-15-3831 PST-15-3833 PST-15-3835 150 mm



Seitenvalven
Lateral Blades
Valvas laterales
Valves latérales
Valve laterali

PST-15-3833 = Fig. 1 30 x 30 mm
PST-15-3834 = Fig. 2 40 x 40 mm
PST-15-3835 = Fig. 3 50 x 50 mm

PST-15-3832



Rippensperrer

Rib Retractors
Separadores costales
Ecarteurs des côtes
Divaricatori costali

De Bakey



mit 3 Paar Valven
with 3 pairs of blades
con 3 pares de valvas
avec 3 paires de valves
con 3 paia di valve

Spreizweite
spreading
abertura
ouverture
apertura

PST-15-3836
PST-15-3837
PST-15-3838 PST-15-3840 PST-15-3842 200 mm

Sperrer allein
Retractor only
Separador suelto
Ecarteur seul
Divaricatore solo

PST-15-3839

Seitenvalven
Lateral Blades
Valvas laterales
Valves latérales
Valve laterali

PST-15-3840 = Fig. 1 60 x 60 mm
PST-15-3841 = Fig. 2 50 x 80 mm
PST-15-3842 = Fig. 3 40 x 100 mm
PST-15-3843 = Fig. 4 80 x 60 mm
PST-15-3844 = Fig. 5 50 x 66 mm

Fig. 1

Fig. 2

Fig. 3

Fig. 4

Fig. 5



Thoraxsperrer

Thoracic Retractor
Separador torácico
Ecarteur thoracique
Divaricatore per il torace



(Mercedes-Sperrer)
(Mercedes Retractor)
(Retractor Mercedes)
(Ecarteur Mercedes)
(Divaricatore Mercedes)

mit je 1 Paar Valven
with 1 pair of blades each
con 1 par de valvas de c.u.
avec chaqun 1 paire de valves
con un paio di valve ognuno

PST-15-3845 PST-15-3847 PST-15-3848

Sperrer allein
Retractor only
Separador suelto
Valves laterales
Divaricatore solo

PST-15-3846



Fig. 2

Seitenvalven
Lateral Blades
Valvas laterales
Valves latérales
Valve laterali

Paar
pair
par
paire
Paio

PST-15-3847 = Fig. 1 48 x 68 mm
PST-15-3848 = Fig. 2 70 x 75 mm



Herz-und
Gefäßchirurgie

Cardiovascular Surgery
Cirugia Cardiovascular
Chirurgie Cardio-vasculaire 15
Chirurgia Cardiovascolare



Quality Instruments

I.M.A.-Thoraxsperrer

Thoracic and I.M.A Retractor
Separador Torácico e I.M.A.
Écarteur thoracique et I.M.A.
Divaricatore per il torace ed I.M.A.



PST-15-3849



Stielvalve für I.M.A. Sperrer
Lateral Blade for I.M.A. Retractor
Valva para separador I.M.A.
Valve pour écarteur I.M.A.
Valve per divaricatore I.M.A.

PST-15-3850 links left izquierda gauche sinistra
PST-15-3851 rechts right derecha droite destra

Rippenkontraktoren

Rib Contractors
Aproximadores para costillas
Rapprocheurs des côtes
Approssimatori costali

PST-15-3852 40 x 50 x 80 mm
PST-15-3853 40 x 50 x 80 mm



Sellors PST-15-3854 20 cm / 7 7/8"
Bailey-Baby PST-15-3855 15,5 cm / 6 1/8"
Bailey PST-15-3856 20 cm / 7 7/8"
Bailey-Gibbon PST-15-3857 20 cm / 7 7/8"
kurze Klauen short claws garras cortas bras courts pinze corte
lange Klauen long claws garras largas bras longs pinze lunghe

Lungenspatel

Lung Spatulas
Espátulas pulmonares
Spatules pulmonaires
Spatole per pulmone



PST-15-3858
29,5 cm / 11 5/8"

PST-15-3859
33 cm / 13"

Allison
PST-15-3858 - PST-15-3859



PST-15-3860
29,5 cm / 11 5/8"



Bronchusklemmen

Bronchus Clamps
Pinzas bronquiales
Pince-clamps à bronches
Pinze per bronchi

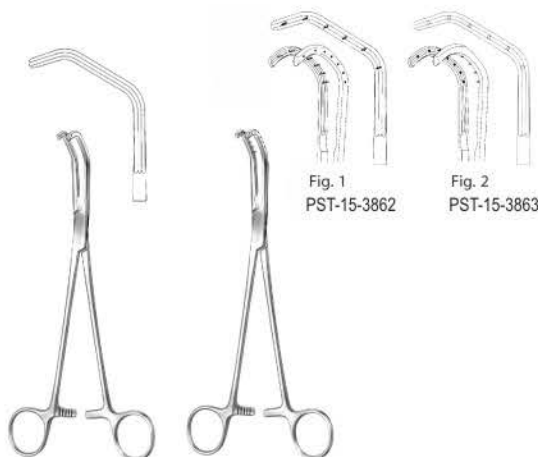

Fig. 1 PST-15-3862
Fig. 2 PST-15-3863

Price-Thomas PST-15-3861 22 cm / 8 5/8"
Price-Thomas PST-15-3862 - PST-15-3863 22 cm / 8 5/8"



Bronchusklemmen

Bronchus Clamps
Pinzas bronquiales
Pince-clamps à bronches
Pinze per bronchi



PST-15-3864
25 cm / 9 7/8"

PST-15-3865
24,5 cm / 9 5/8"

Semb
PST-15-3864 - PST-15-3865



Herz-und
Gefäßchirurgie

Cardiovascular Surgery
Cirugia Cardiovascular
Chirurgie Cardio-vasculaire
Chirurgia Cardiovascolare

15



Quality Instruments

Lungenfazzangen

Lung Grasping Forceps
Pinzas para coger el pulmón
Pince-clamps à poumons
Pinze per afferrare polmone

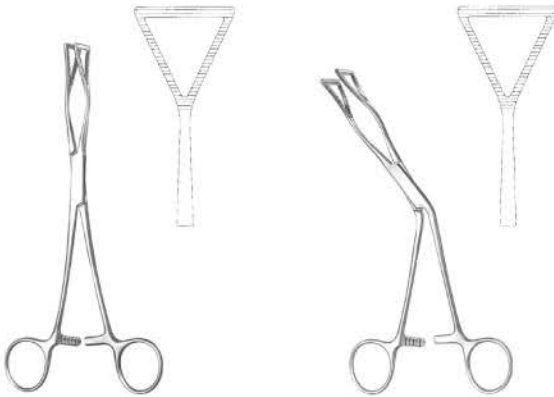

Lovelace
PST-15-3866
20,5 cm / 8 1/8"

Lovelace
PST-15-3867
19 cm / 7 4/8"

Bulldogklemmen

Bulldog Clamps
Clamps Bulldog
Clamps Bulldog
Pinze Bulldog



De Bakey-Satinsky
PST-15-3868
7 cm / 2 6/8"

De Bakey-Satinsky
PST-15-3869
9 cm / 3 4/8"

De Bakey-Satinsky
PST-15-3870
10 cm / 3 7/8"



Glover
PST-15-3871
6,5 cm / 2 4/8"



Santulli
PST-15-3872
7 cm / 2 6/8"



Bulldogklemmen

Bulldog Clamps
Clamps Bulldog
Clamps Bulldog
Pinze Bulldog



PST-15-3873
9 cm / 3 4/8"

PST-15-3874
11 cm / 4 3/8"

PST-15-3875
11 cm / 4 3/8"

PST-15-3876
11 cm / 4 3/8"



Gregory, soft
PST-15-3873 - PST-15-3874
Carotis-Bulldogklemme
Carotid clamp
Clamp para carotis
Pince pour carotide
Pinza carotis



Gregory
PST-15-3875 - PST-15-3876
Carotis-Bulldogklemme
Carotid clamp
Clamp para carotis
Pince pour carotide
Pinza carotis



Arterienklemmen

Haemostatic Forceps
Pinzas hemostáticas
Pinces hémostatiques
Pinze emostatiche

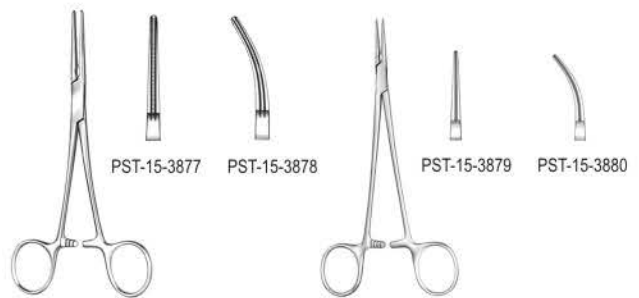

De Bakey-Rankin
PST-15-3877 - PST-15-3878
16 cm / 6 2/8"

De Bakey-Mosquito
PST-15-3879 - PST-15-3880
15 cm / 5 7/8"

Herz-und
Gefäßchirurgie

Cardiovascular Surgery
Cirugia Cardiovascular
Chirurgie Cardio-vasculaire
Chirurgia Cardiovascolare

15



Quality Instruments

Aortaklemmen

Aortic Clamps
Pinzas aórticas
Pincers-clamps pour aorte
Pinze per aorta



Ochsner
PST-15-3881
22 cm / 8 5/8"

Diethrich
PST-15-3882
22 cm / 8 5/8"

Mehrzweck-Gefäßklemmen

Multi purpose Vascular Clamps
Pinzas vasculares de usos múltiples
Pincers vasculaires universelles
Pinze vascolari universali

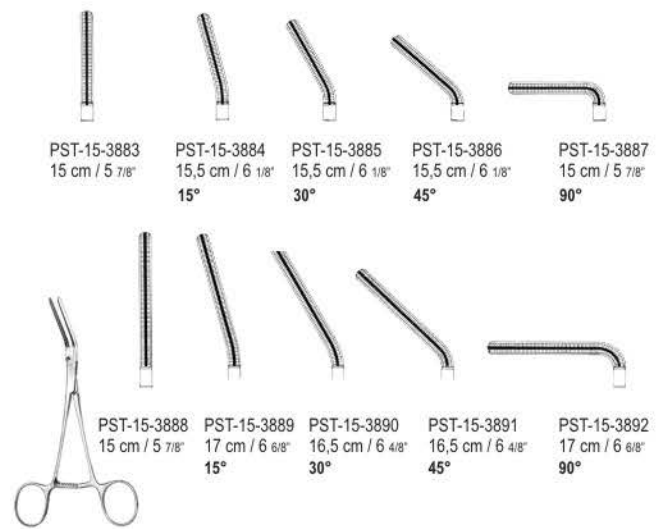

PST-15-3883 15 cm / 5 7/8"
PST-15-3884 15,5 cm / 6 1/8" 15°
PST-15-3885 15,5 cm / 6 1/8" 30°
PST-15-3886 15,5 cm / 6 1/8" 45°
PST-15-3887 15 cm / 5 7/8" 90°

PST-15-3888 15 cm / 5 7/8"
PST-15-3889 17 cm / 6 6/8" 15°
PST-15-3890 16,5 cm / 6 4/8" 30°
PST-15-3891 16,5 cm / 6 4/8" 45°
PST-15-3892 17 cm / 6 6/8" 90°

Dardik
PST-15-3883 - PST-15-3892

Peripheral-Gefäßklemmen

Peripheral Vascular Clamps
Pinzas para vasos periféricos
Pincers-clamps vasculaires périphériques
Pinze vascolari periferali

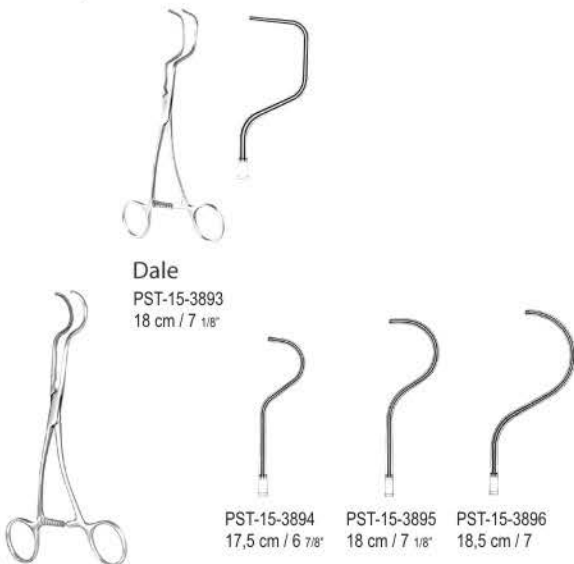

Dale
PST-15-3893
18 cm / 7 1/8"

PST-15-3894 17,5 cm / 6 7/8"
PST-15-3895 18 cm / 7 1/8"
PST-15-3896 18,5 cm / 7"

Dale
PST-15-3894 - PST-15-3896

Profundaklemmen

Profunda Clamps
Pinzas para la profunda
Pincers fémorale
Pinze profunda

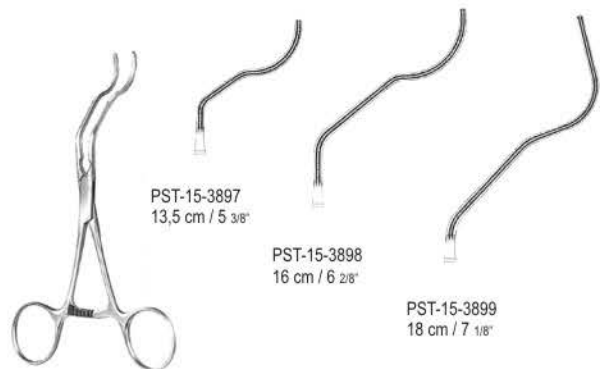

PST-15-3897
13,5 cm / 5 3/8"

PST-15-3898
16 cm / 6 2/8"

PST-15-3899
18 cm / 7 1/8"

Gregory
PST-15-3897 - PST-15-3899



Carotis-Shuntklemmen

Carotid Shunt Clamps
Pinzas para shunt carótido
Pincés pour carotide
Pinze carotis

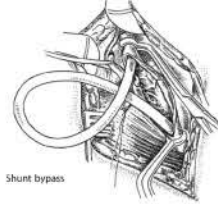

Javid
PST-15-3900
17,5 cm / 6 7/8"



Javid
PST-15-3901
18,5 cm / 7 2/8"



Peripheral-Gefäßklemmen

Peripheral Vascular Clamps
Pinzas para vasos periféricos
Pincés-clamps vasculaires périphériques
Pinze vascolari periferali

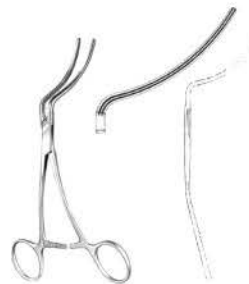

Martin
PST-15-3902
16 cm / 6 2/8"



Martin
PST-15-3903
17 cm / 6 6/8"



Peripheral-Gefäßklemmen

Peripheral Vascular Clamps
Pinzas para vasos periféricos
Pincés-clamps vasculaires périphériques
Pinze vascolari periferali

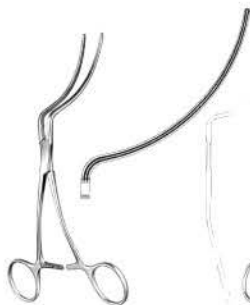

Martin
PST-15-3904
18 cm / 7 1/8"

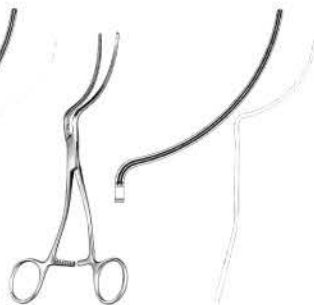

Martin
PST-15-3905
19,5 cm / 7 5/8"



Aortaklemmen

Aortic Clamps
Pinzas aórticas
Pincés-clamps pour aorte
Pinze per aorta



Wylie
PST-15-3906
24 cm / 9 4/8"

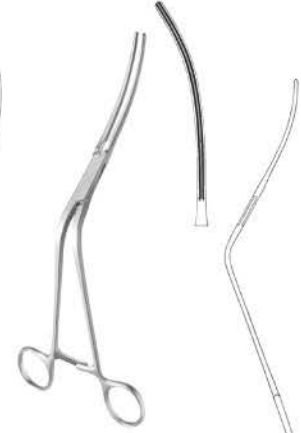

Wylie
PST-15-3907
27 cm / 10 5/8"



Herz-und
Gefäßchirurgie

Cardiovascular Surgery
Cirugia Cardiovascular
Chirurgie Cardio-vasculaire
Chirurgia Cardiovascolare

15



Quality Instruments

Aortaklemmen

Aortic Clamps
Pinzas aórticas
Pincas-clamps pour aorte
Pinze per aorta



De Bakey
PST-15-3908
30 cm / 11 6/8"

Peripheral-Gefäßklemmen

Peripheral Vascular Clamps
Pinzas para vasos periféricos
Pincas-clamps vasculaires périphériques
Pinze vascolari periferali

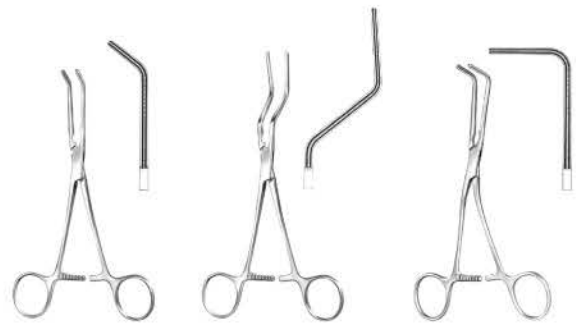
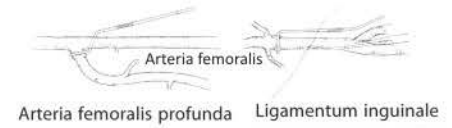

Husfeldt
PST-15-3909
16,5 cm / 6 4/8"

Husfeldt
PST-15-3910
18 cm / 7 1/8"

Husfeldt
PST-15-3911
17 cm / 6 6/8"



Gefäß-Messzirkel

Vascular Measuring Device
Compas para medir vasos
Compas pour mesurer la longueur des vaisseaux
Pinza vascolare compasso

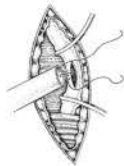

Martin
PST-15-3912
18 cm / 7 1/8"

Katheterklemmen

Catheter Clamps
Pinzas para catéteres
Pincas pour sondes
Pinze per cateteri

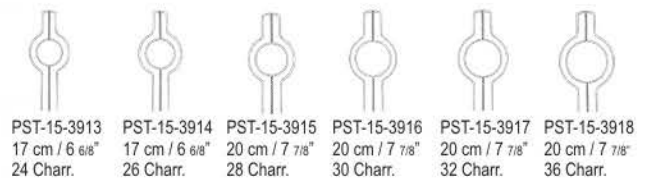

Cooley
PST-15-3913 - PST-15-3918



Herz-und
Gefäßchirurgie

Cardiovascular Surgery
Cirugia Cardiovascular
Chirurgie Cardio-vasculaire
Chirurgia Cardiovascolare

15



Quality Instruments

Gefäßspinzetten

Vascular Forceps
Pinzas de disección vascular
Pinces à dissection vasculaires
Pinze per dissezione vascolari

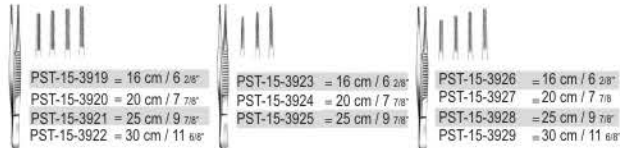

De Bakery
2.7 mm

De Bakery
1.5 mm

De Bakery
2.0 mm

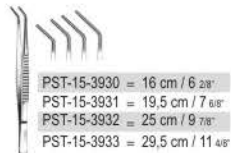

De Bakery
2.0 mm

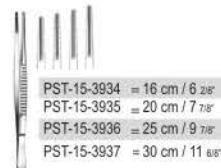

De Bakery
3.5 mm

Bulldogklemmen

Bulldog Clamps
Clamps Bulldog
Clamps Bulldog
Pinze Bulldog

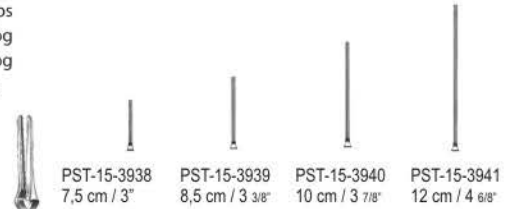

PST-15-3938
7,5 cm / 3"

PST-15-3939
8,5 cm / 3 3/8"

PST-15-3940
10 cm / 3 7/8"

PST-15-3941
12 cm / 4 6/8"

De Bakery
PST-15-3938 - PST-15-3941

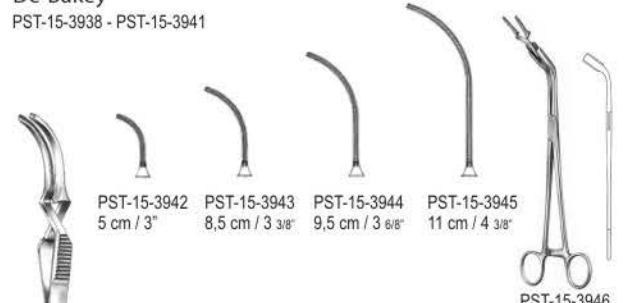

De Bakery
PST-15-3942 - PST-15-3945

PST-15-3942 = 5 cm / 3"
PST-15-3943 = 8,5 cm / 3 3/8"
PST-15-3944 = 9,5 cm / 3 6/8"
PST-15-3945 = 11 cm / 4 3/8"
PST-15-3946 = 24 cm / 9 4/8"
Anlegezange für Bulldogklemmen
Applying Forceps for Bulldog clamps
Pinza aplicadora para clamps bulldog
Pinze pour poser les clamps Bulldog
Pinza per posizionare le pinze Bulldog

Bulldogklemmen

Bulldog Clamps
Clamps Bulldog
Clamps Bulldog
Pinze Bulldog

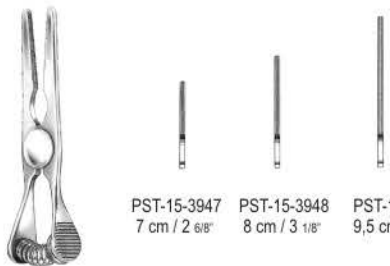

PST-15-3947
7 cm / 2 6/8"

PST-15-3948
8 cm / 3 1/8"

PST-15-3949
9,5 cm / 3 6/8"

Glover
PST-15-3947 - PST-15-3949

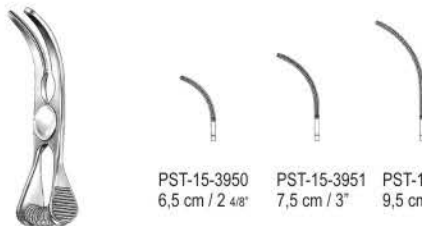

PST-15-3950
6,5 cm / 2 4/8"

PST-15-3951
7,5 cm / 3"

PST-15-3952
9,5 cm / 3 4/8"

Glover
PST-15-3950 - PST-15-3952

Coarctationsklemmen

Coarctation Clamps
Pinzas para coarctación
Pinces-clamps pour coarctation
Pinze per coarctazione



PST-15-3953
21 cm / 8 2/8"

PST-15-3954
22,5 cm / 8 7/8"

PST-15-3955
20,5 cm / 8 1/8"

PST-15-3956
22 cm / 8 5/8"

Potts
PST-15-3953 - PST-15-3954

Potts
PST-15-3955 - PST-15-3956

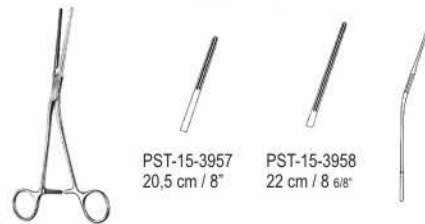

PST-15-3957
20,5 cm / 8"

PST-15-3958
22 cm / 8 6/8"

Potts
PST-15-3957 - PST-15-3958



Herz-und
Gefäßchirurgie

Cardiovascular Surgery
Cirugia Cardiovascular
Chirurgie Cardio-vasculaire
Chirurgia Cardiovascolare

15



Quality Instruments

Anastomosenklemmen, Ligaturklemmen

Anastomosis Clamps, Ligature Forceps
Pinzas para anastomosis, Pinzas para ligaduras
Pinces-clamps à anastomose, Pinces à ligatures
Pinze per anastomosi, Pinze per legature



Potts
PST-15-3959
21,5 cm / 8 4/8"



Potts
PST-15-3960
22 cm / 8 5/8"



PST-15-3961
19 cm / 7 4/8"



PST-15-3962
24 cm / 9 4/8"

De Bakey
PST-15-3961 - PST-15-3962
Präparier- und Ligaturklemme
Dissecting and Ligature Forceps
Pinza para preparaciones y ligaduras
Pince à disséquer et à ligatures
Pinza per preparazioni e legature

Peripheral-Gefäßklemmen

Peripheral Vascular Clamps
Pinzas para vasos periféricos
Pinces-clamps vasculaires périphériques
Pinze vascolari periferali



De Bakey
PST-15-3963
16 cm / 6 2/8"



De Bakey
PST-15-3964
19 cm / 7 4/8"



De Bakey
PST-15-3965
20 cm / 7 7/8"

Peripheral-Gefäßklemmen

Peripheral Vascular Clamps
Pinzas para vasos periféricos
Pinces-clamps vasculaires périphériques
Pinze vascolari periferali



Leland-Jones
PST-15-3966 - PST-15-3968

PST-15-3966
18 cm / 7 1/8"



PST-15-3967
19 cm / 7 4/8"



PST-15-3968
20 cm / 7 7/8"

Mehrzweck-Gefäßklemmen

Multi purpose Vascular Clamps
Pinzas vasculares de usos múltiples
Pinces vasculaires universelles
Pinze vascolari universali



Bainbridge
PST-15-3969 - PST-15-3970



PST-15-3969
15 cm / 5"



PST-15-3970
18,5 cm / 7 2/8"



Bainbridge
PST-15-3971 - PST-15-3972



PST-15-3971
15 cm / 5 7/8"



PST-15-3972
18,5 cm / 7 2/8"

Herz-und
Gefäßchirurgie

Cardiovascular Surgery
Cirugia Cardiovascular
Chirurgie Cardio-vasculaire
Chirurgia Cardiovascolare

15



Quality Instruments

Mehrzweck-Gefäßklemmen

Multi purpose Vascular Clamps
Pinzas vasculares de usos múltiples
Pincas vasculaires universelles
Pinze vascolari universali

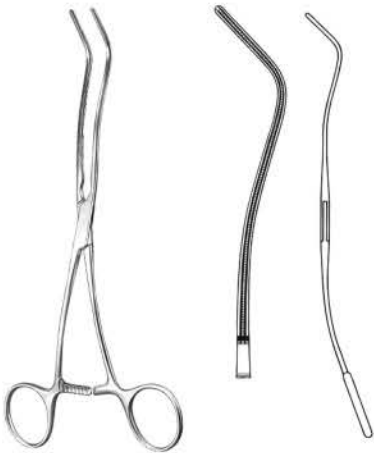

De Bakey
PST-15-3973
20 cm / 7 7/8"

Aorta-Aneurysmaklemmen

Aortic Aneurysm Clamps
Pinzas para aneurisma de aórtica
Pincas-clamps pour anévrisme de l'aorte
Pinze per aneurisma della aorta

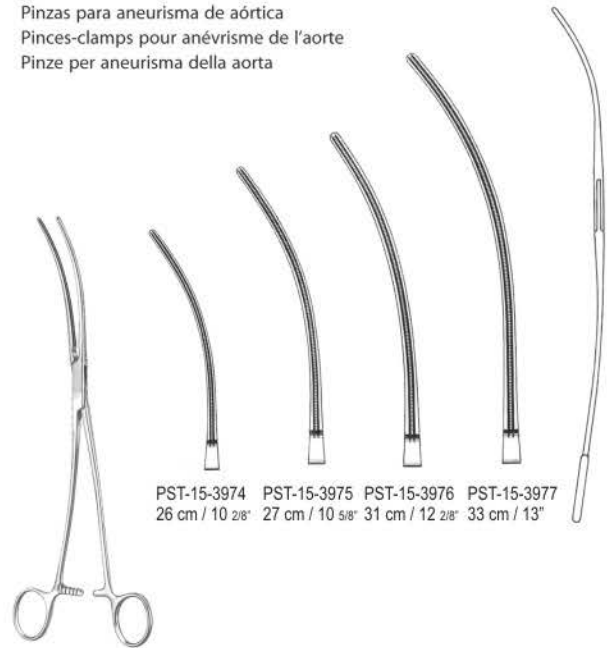

PST-15-3974 26 cm / 10 2/8"
PST-15-3975 27 cm / 10 5/8"
PST-15-3976 31 cm / 12 2/8"
PST-15-3977 33 cm / 13"

De Bakey
PST-15-3974 - PST-15-3977



Aorta-Aneurysmaklemmen

Aortic Aneurysm Clamps
Pinzas para aneurisma de aórtica
Pincas-clamps pour anévrisme de l'aorte
Pinze per aneurisma della aorta



De Bakey
PST-15-3978
28 cm / 11"

De Bakey
PST-15-3979
30 cm / 11 6/8"



Aorta-Ligaturklemmen

Aortic Ligature Forceps
Pinzas aórticas para ligaduras
Pincas-clamps pour aorte à ligatures
Pinze per aorta per legature

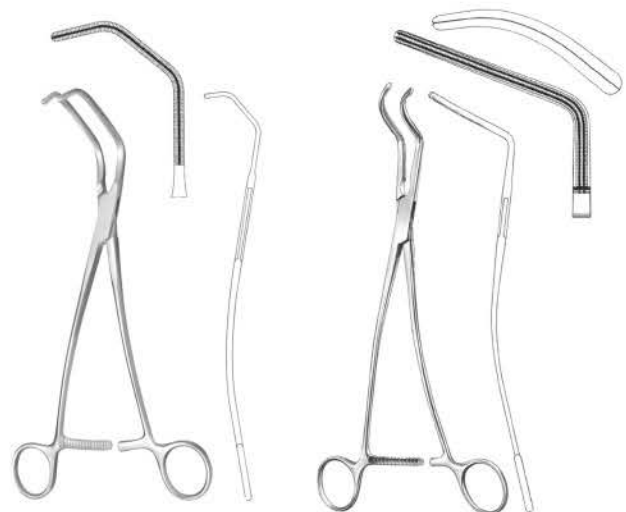

Cooley
PST-15-3980
25 cm / 9 7/8"

De Bakey
PST-15-3981
27 cm / 10 5/8"



Herz-und
Gefäßchirurgie

Cardiovascular Surgery
Cirugia Cardiovascular
Chirurgie Cardio-vasculaire
Chirurgia Cardiovascolare

15



Quality Instruments

Ligaturklemmen, Aortaklemmen

Ligature Forceps, Aortic Clamps
Pinzas para ligaduras, Pinzas aórticas
Pincers à ligatures, Pincers-clamps pour aorte
Pinze per legature, Pinze per aorta



De Bakey

PST-15-3982
24,5 cm / 9 5/8"

De Bakey

PST-15-3983
24,5 cm / 9 5/8"

Ligaturklemmen, Aortaklemmen

Ligature Forceps
Pinzas para ligaduras
Pincers à ligatures
Pinze per legature

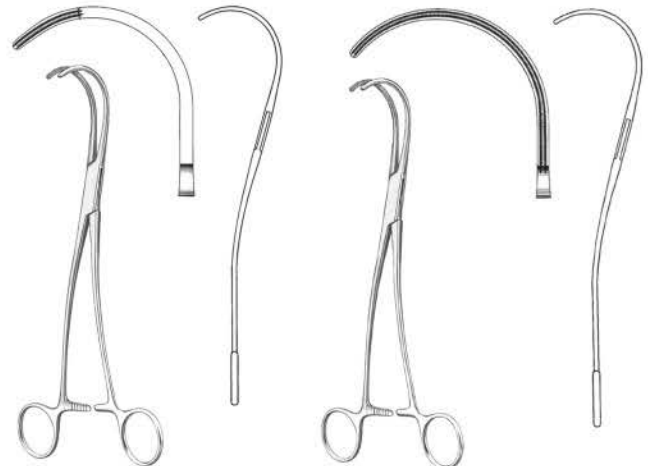

De Bakey

PST-15-3984
27 cm / 10 5/8"

De Bakey

PST-15-3985
27 cm / 10 5/8"



Aortaklemmen

Aortic Clamps
Pinzas aórticas
Pincers-clamps pour aorte
Pinze per aorta

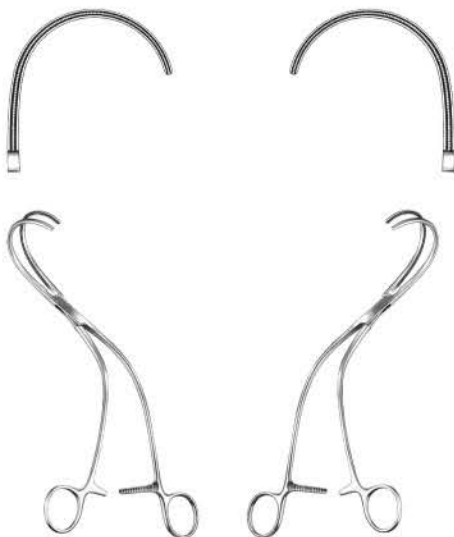

Weber

PST-15-3986
24 cm / 9 4/8"

Weber

PST-15-3987
24 cm / 9 4/8"

Aorta-Anastomosenklemmen, Vena Cava-Klemmen

Aorta-Anastomosis Clamps, Forceps for Vena Cava
Pinzas para anastomosis-aórticas, Pinzas para Vena Cava
Pincers-clamps à anastomose-aorte, Pincers pour Vena Cava
Pinze per anastomosi-aorta, Pinze per Vena Cava

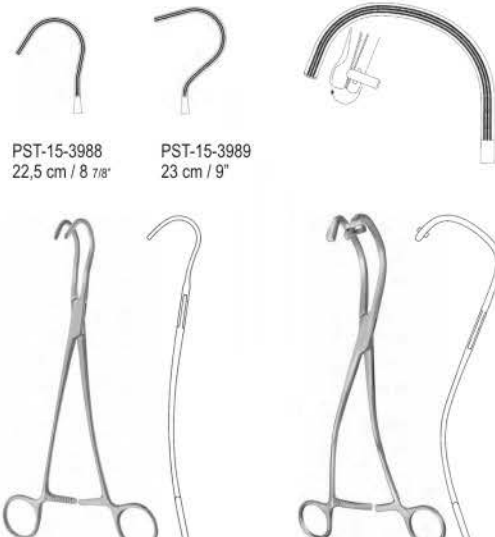

PST-15-3988
22,5 cm / 8 7/8"

PST-15-3989
23 cm / 9"

выиie

PST-15-3988 - PST-15-3989

Calne

PST-15-3990
27 cm / 10 5/8"



Herz-und
Gefäßchirurgie

Cardiovascular Surgery
Cirugia Cardiovascular
Chirurgie Cardio-vasculaire
Chirurgia Cardiovascolare

15



Quality Instruments

Leberklemmen

Liver Forceps
Pinzas para higado
Pincers pour le foie
Pinze per il fegato

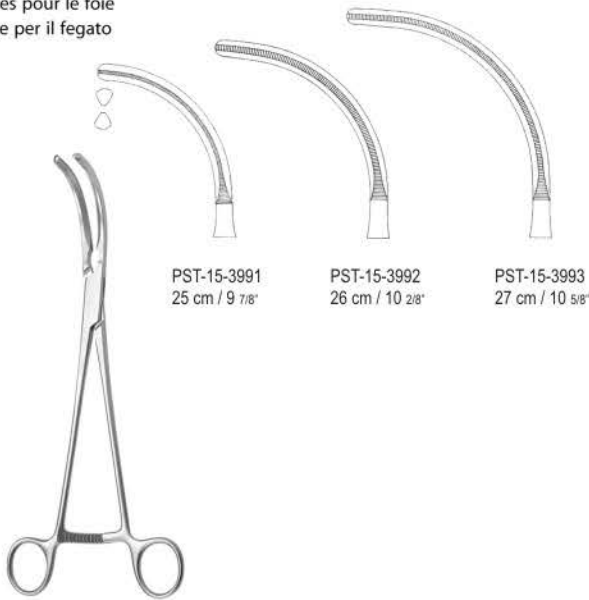

PST-15-3991
25 cm / 9 7/8"

PST-15-3992
26 cm / 10 2/8"

PST-15-3993
27 cm / 10 5/8"

Pittsburgh

PST-15-3991 - PST-15-3993



Nieren u.- Pankreas-Klemmen

Forceps for kidney and pancreas
Pinzas para riñón y pancreas
Pincers pour le rein et pancréas
Pinze per il rene e pancreas

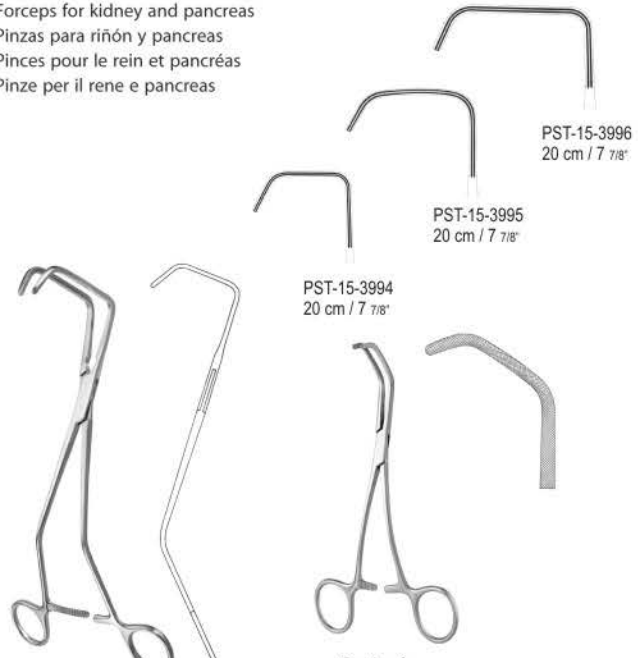

PST-15-3994
20 cm / 7 7/8"

PST-15-3995
20 cm / 7 7/8"

PST-15-3996
20 cm / 7 7/8"

Satinsky

PST-15-3997
15.5 cm / 6"

PST-15-3994 - PST-15-3996



Tangentialklemmen

Tangential Occlusion Clamps
Pinzas para oclusión tangencial
Pincers-clamps pour occlusion tangentielle
Pinze per occlusione tangenziale

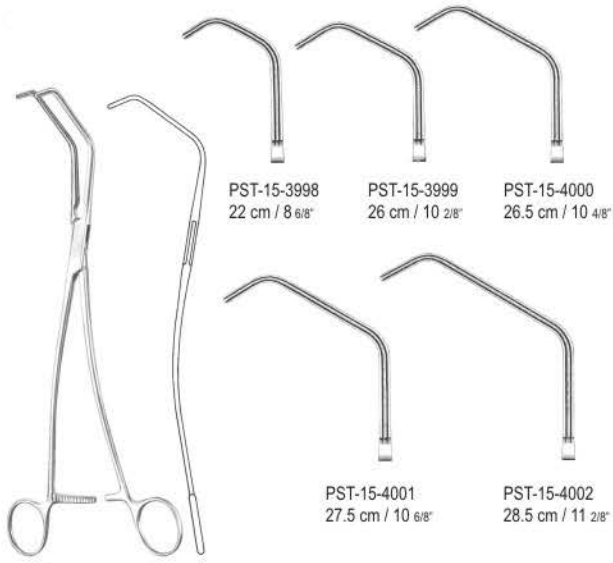

PST-15-3998
22 cm / 8 5/8"

PST-15-3999
26 cm / 10 2/8"

PST-15-4000
26.5 cm / 10 4/8"

PST-15-4001
27.5 cm / 10 6/8"

PST-15-4002
28.5 cm / 11 2/8"

Satinsky

PST-15-3998 - PST-15-4002



Aurikelklemmen

Auricle Clamps
Pinzas para aurícula
Pincers auriculaires
Pinze ventricolari



PST-15-4003
24.5 cm / 9 5/8"

PST-15-4004
24 cm / 9 4/8"

PST-15-4005
23 cm / 9"

PST-15-4006
23.5 cm / 9 2/8"

Harken

PST-15-4003 - PST-15-4006



Herz-und
Gefäßchirurgie

Cardiovascular Surgery
Cirugia Cardiovascular
Chirurgie Cardio-vasculaire
Chirurgia Cardiovascolare

15



Quality Instruments

Bronchusklemmen

Bronchus Clamps
Pinzas bronquiales
Pinces-clamps à bronches
Pinze per bronchi

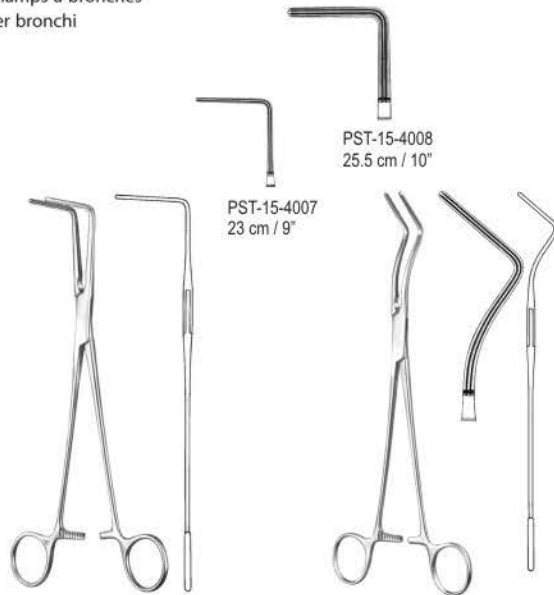

Lees

PST-15-4007 - PST-15-4008

Lees

PST-15-4009
26 cm / 10 2/8"

PST-15-4008
25.5 cm / 10"

PST-15-4007
23 cm / 9"

Anastomosenklemmen

Anastomosis Clamps
Pinzas para anastomosis
Pinces-clamps pour anastomose
Pinze per anastomosi



Glover

PST-15-4010 - PST-15-4011

PST-15-4010
18 cm / 7 1/8"

PST-15-4011
22 cm / 8 5/8"

Aorta-Anastomosenklemmen

Aorta-Anastomosis Clamps
Pinzas para anastomosis-aórticas
Pinces-clamps à anastomose-aorte
Pinze per anastomosi-aorta

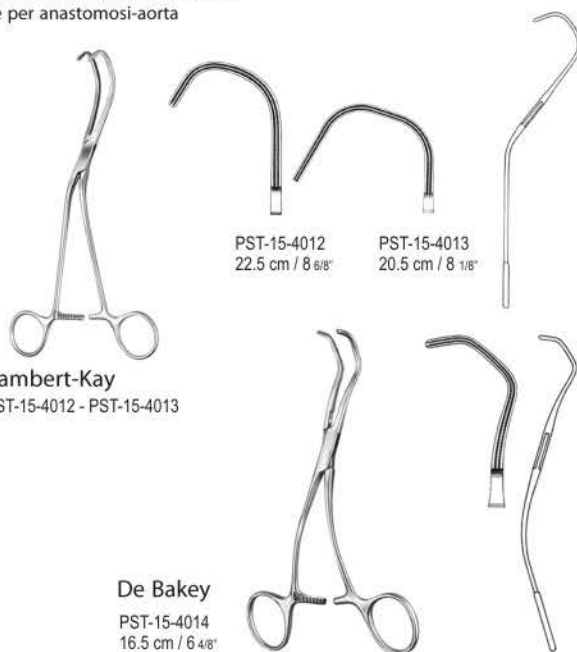

Lambert-Kay

PST-15-4012 - PST-15-4013

De Bakey

PST-15-4014
16.5 cm / 6 4/8"

PST-15-4012
22.5 cm / 8 6/8"

PST-15-4013
20.5 cm / 8 1/8"

Aortaklemmen

Aortic Clamps
Pinzas aórticas
Pinces-clamps pour aorte
Pinze per aorta

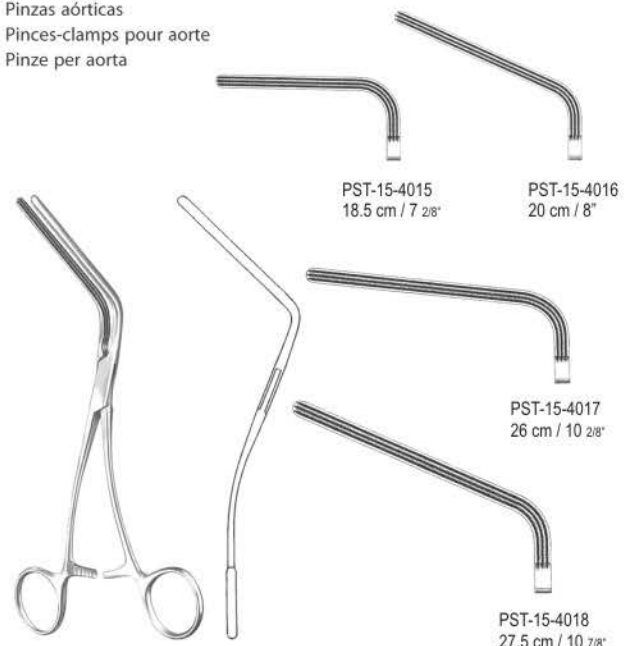

PST-15-4015
18.5 cm / 7 2/8"

PST-15-4016
20 cm / 8"

PST-15-4017
26 cm / 10 2/8"

PST-15-4018
27.5 cm / 10 7/8"

Morris-De Bakey

PST-15-4015 - PST-15-4018

Herz-und
Gefäßchirurgie

Cardiovascular Surgery
Cirugia Cardiovascular
Chirurgie Cardio-vasculaire
Chirurgia Cardiovascolare

15



Quality Instruments

Aneurysmaklemmen

Aneurysm Clamps
Pinzas para aneurisma
Pincas-clamps pour anévrisme
Pinze per aneurisma

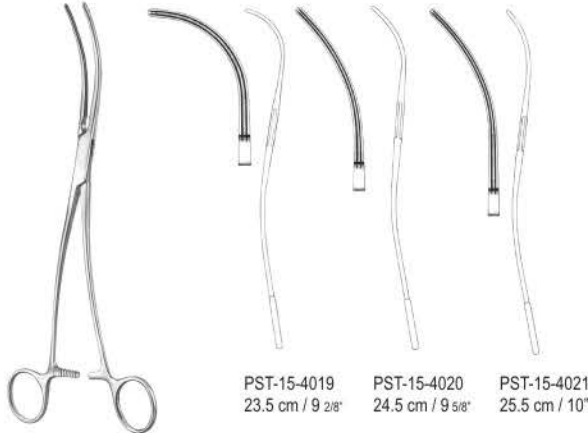

De Bakey-Bahnsen
PST-15-4019 - PST-15-4021

Mehrzweck-Gefäßklemmen

Multi purpose Vascular Clamps
Pinzas vasculares de usos múltiples
Pincas vasculaires universelles
Pinze vascolari universali

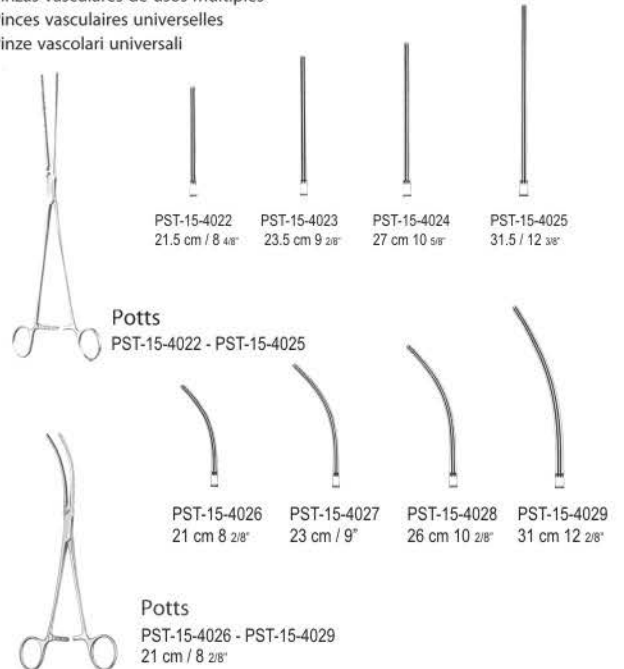

Potts
PST-15-4022 - PST-15-4025

Potts
PST-15-4026 - PST-15-4029
21 cm / 8 2/8"



Mehrzweck-Gefäßklemmen

Multi purpose Vascular Clamps
Pinzas vasculares de usos múltiples
Pincas vasculaires universelles
Pinze vascolari universali

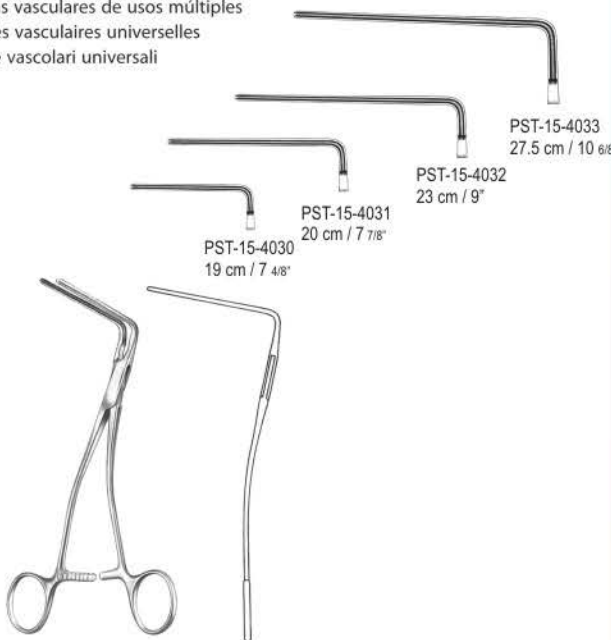

De Bakey
PST-15-4030 - PST-15-4033

Mehrzweck-Gefäßklemmen

Multi purpose Vascular Clamps
Pinzas vasculares de usos múltiples
Pincas vasculaires universelles
Pinze vascolari universali

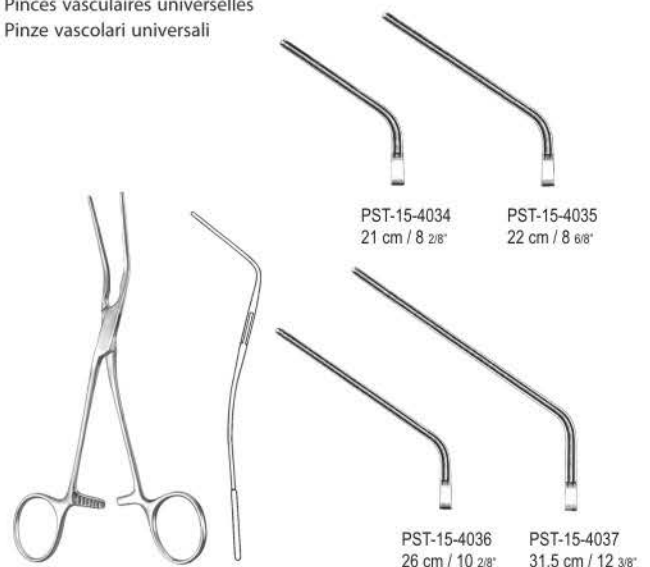

De Bakey
PST-15-4034 - PST-15-4037



Herz-und
Gefäßchirurgie

Cardiovascular Surgery
Cirugia Cardiovascular
Chirurgie Cardio-vasculaire
Chirurgia Cardiovascolare

15



Quality Instruments

Arterienklemmen
Haemostatic Forceps
Pinzas hemostáticas
Pincès hémostatiques
Pinze emostatiche

PST-15-4038 12.5 cm / 4 7/8"
PST-15-4039 12.5 cm / 4 7/8"
PST-15-4040 14.5 cm / 5 5/8"
PST-15-4041 16.5 cm / 6 4/8"
PST-15-4042 18.5 cm / 7 2/8"
PST-15-4043 20.5 cm / 8 1/8"

De Bakey-Mosquito
PST-15-4038
PST-15-4039

De Bakey-Pean
PST-15-4040 - PST-15-4043

De Bakey-Pean
PST-15-4044
PST-15-4047

PST-15-4044 14.5 cm / 5 5/8"
PST-15-4045 16.5 cm / 6 4/8"
PST-15-4046 18.5 cm / 7 2/8"
PST-15-4047 20 cm / 7 7/8"

Mehrzweck-Gefäßklemmen
Multi purpose Vascular Clamps
Pinzas vasculares de usos múltiples
Pincès vasculaires universelles
Pinze vascolari universali

Atrauma

De Bakey
PST-15-4048
17.5 cm / 6 7/8"

De Bakey
PST-15-4049
16.5 cm / 6 4/8"

De Bakey
PST-15-4050
16 cm / 6 2/8"

Mehrzweck-Gefäßklemmen
Multi purpose Vascular Clamps
Pinzas vasculares de usos múltiples
Pincès vasculaires universelles
Pinze vascolari universali

De Bakey
PST-15-4051
15 cm / 5 7/8"

De Bakey
PST-15-4052
16.5 cm / 6 4/8"

Glover
PST-15-4053
17 cm / 6 5/8"

Glover
PST-15-4054
17.5 cm / 6 7/8"

Anastomosenklemmen
Anastomosis Clamps
Pinzas para anastomosis
Pincès pour anastomose
Pinze per anastomosi

PST-15-4055
16.5 cm / 6 4/8"

PST-15-4056
16.5 cm / 6 4/8"

De Bakey
PST-15-4055 - PST-15-4056

Herz-und
Gefäßchirurgie

Cardiovascular Surgery
Cirugia Cardiovascular
Chirurgie Cardio-vasculaire
Chirurgia Cardiovascolare

15



Quality Instruments

Anastomosenklemmen

Anastomosis Clamps
Pinzas para anastomosis
Pincas pour anastomose
Pinze per anastomosi



Derra

PST-15-4057 - PST-15-4059

Fig. 1
PST-15-4057
16.5 cm / 6 4/8"

Fig. 2
PST-15-4058
17 cm / 6 6/8"

Fig. 3
PST-15-4059
17.5 cm / 6 5/8"



De Bakey-Beck
PST-15-4060
17 cm / 6 6/8"



Kinder-Gefäßklemmen

Pediatric Vascular Clamps
Pinzas vasculares pediátricas
Pincas vasculaires pédiatriques
Pinze vascolari pediatriche



De Bakey
PST-15-4061
10 cm / 3 7/8"

PST-15-4062
13 cm / 5 1/8"

PST-15-4063
13 cm / 5 1/8"



De Bakey
PST-15-4064
12.5 cm / 4 7/8"



De Bakey
PST-15-4065
12.5 cm / 4 7/8"



Gefäßpinzetten

Vascular Forceps
Pinzas de disección vascular
Pincas à dissection vasculaires
Pinze per dissezione vascolari

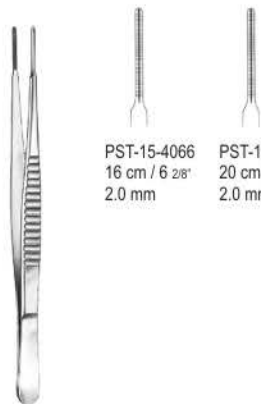

Cooley
PST-15-4066 - PST-15-4067

PST-15-4066
16 cm / 6 2/8"
2.0 mm

PST-15-4067
20 cm / 7 7/8"
2.0 mm



Kinder-Gefäßklemmen

Pediatric Vascular Clamps
Pinzas vasculares pediátricas
Pincas vasculaires pédiatriques
Pinze vascolari pediatriche

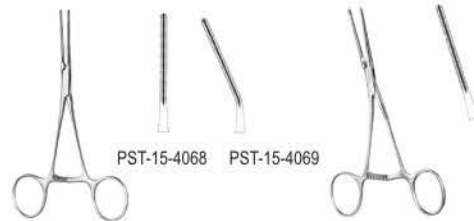

Cooley
PST-15-4068 - PST-15-4069
14.5 cm / 5 6/8"

Cooley
PST-15-4070
14.5 cm / 5 6/8"



Cooley
PST-15-4071
14 cm / 5 4/8"



Cooley
PST-15-4072
14.5 cm / 5 6/8"



Herz-und
Gefäßchirurgie

Cardiovascular Surgery
Cirugia Cardiovascular
Chirurgie Cardio-vasculaire
Chirurgia Cardiovascolare

15



Quality Instruments

Anastomosenklemmen, Mehrzweck-Gefäßklemmen

Anastomosis Clamps, Multi purpose Vascular Clamps
Pinzas para anastomosis, Pinzas vasculares de usos múltiples
Pinces-clamps pour anastomose, Pinces vasculaires universelles
Pinze per anastomosi, Pinze vascolari universali



Cooley
PST-15-4073
22 cm / 8 5/8"
Iliacklemme
Iliac Clamp
Pinza para iliaca
Pinze-clamps iliaque
Pinza iliaca



Cooley
PST-15-4074
17 cm / 6 6/8"



Cooley
PST-15-4075
Carotisklemme
Carotid Clamp
Pinza para carótida
Pinze-clamps pour carotide
Pinze per carotis



Cooley
PST-15-4076
17 cm / 6 6/8"

Anastomosenklemmen, Mehrzweck-Gefäßklemmen

Anastomosis Clamps, Multi purpose Vascular Clamps
Pinzas para anastomosis, Pinzas vasculares de usos múltiples
Pinces-clamps pour anastomose, Pinces vasculaires universelles
Pinze per anastomosi, Pinze vascolari universali



Cooley
PST-15-4077
16 cm / 6 2/8"



Cooley
PST-15-4078
14.5 cm / 5 6/8"



Cooley
PST-15-4079
16 cm / 6 2/8"



Cooley
PST-15-4080
16.5 cm / 6 4/8"

Mehrzweck-Gefäßklemmen, Anastomosenklemmen

Multi purpose Vascular Clamps, Anastomosis Clamps
Pinzas vasculares de usos múltiples, Pinzas para anastomosis
Pinces vasculaires universelles, Pinces-clamps pour anastomose
Pinze vascolari universali, Pinze per anastomosi



Cooley
PST-15-4081
17 cm / 6 6/8"



Cooley
PST-15-4082
17 cm / 6 6/8"



Cooley
PST-15-4083
17.5 cm / 6 7/8"



Cooley
PST-15-4084 - PST-15-4085



PST-15-4084
16.5 cm / 6 4/8"



PST-15-4085
16.5 cm / 6 4/8"

Anastomosenklemmen

Anastomosis Clamps
Pinzas para anastomosis
Pinces-clamps pour anastomose
Pinze per anastomosi



Cooley-Derra
PST-15-4086 - PST-15-4088



PST-15-4086
16.5 cm / 6 4/8"



PST-15-4087
17 cm / 6 6/8"



PST-15-4088
17.5 cm / 6 7/8"



Cooley-Beck
PST-15-4089
17 cm / 6 6/8"

Herz-und
Gefäßchirurgie

Cardiovascular Surgery
Cirugia Cardiovascular
Chirurgie Cardio-vasculaire
Chirurgia Cardiovascolare

15



Quality Instruments

Gefäßdilatoren

Vascular Dilators
Dilatadores vasculares
Dilatateurs vasculaires
Dilatatori vascolari

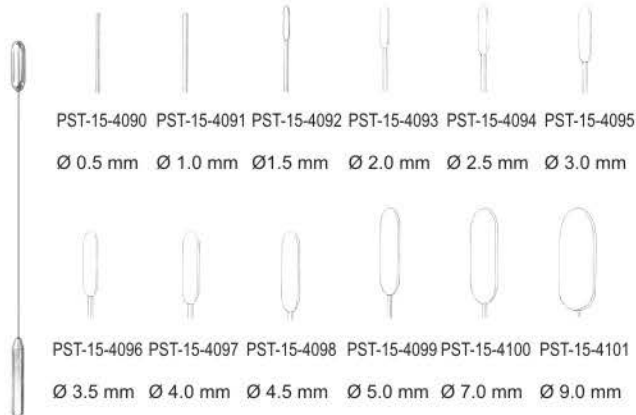

De Bakey

PST-15-4090 - PST-15-4101
19 cm / 7 4/8"



Fasziotomiemesser, Fasziotomiespatel

Fasciotomy Knife, Fasciotomy Spatulas
Cuchillo para fasciotomia, Espátulas para fasciotomia
Couteau pour fasciotomie, Spatule pour fasciotomie
Bisturi per fasciotomia, Spatole per fasciotomia



Hach

PST-15-4102
30 cm / 11 6/8"



Hach

PST-15-4103 - PST-15-4106
30 cm / 11 6/8"



Intimaspatel, Gefäßdissektoren

Intima Spatulas, Vascular Dissectors
Espátulas para la íntima, Disecadores vasculares
Spatules pour la tunique interne, Dissecteurs vasculaires
Spatole per intima, Dissettori vascolari

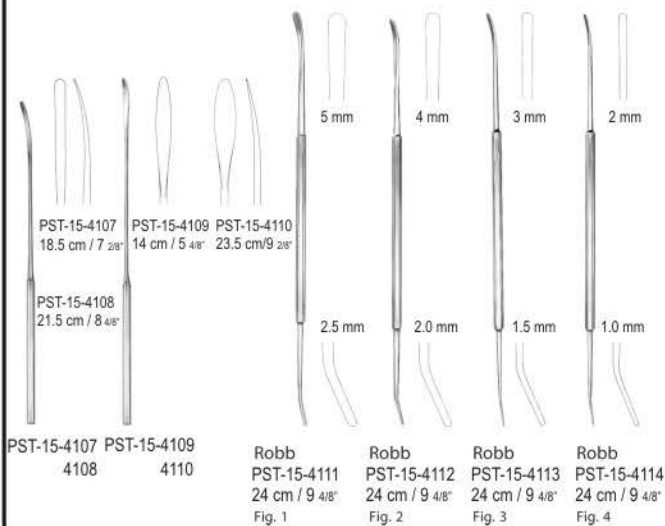

Nervhäkchen, Fadenfänger

Nerve Hooklets, Tourniquets
Ganchitos para nervios, Tourniquets
Crochets pour les nerfs, Tourniquets
Uncini per nervi, Tornichetti

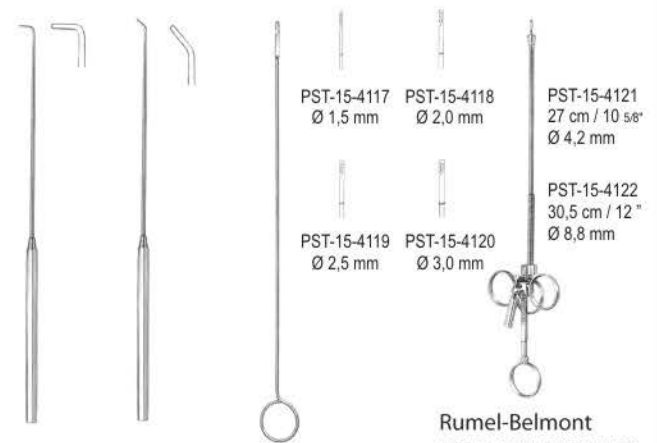

Crile

PST-15-4115
20 cm / 7 7/8"

Crile

PST-15-4116
20.5 cm / 8 1/8"

PST-15-4117 - 4120
26 cm / 10 2/8"

Rumel-Belmont

PST-15-4121 - PST-15-4122





Kinder-Aortaklemmen, Kinder-Gefäßklemmen

Pediatric Aortic Clamps, Pediatric Vascular Clamps
Pinzas aórticas pediátricas, Pinzas vasculares pediátricas
Pincés-clamps pour aorte pédiatriques, Pincés vasculaires pédiatriques
Pinze per aorta pediatriche, Pinze vascolari pediatriche

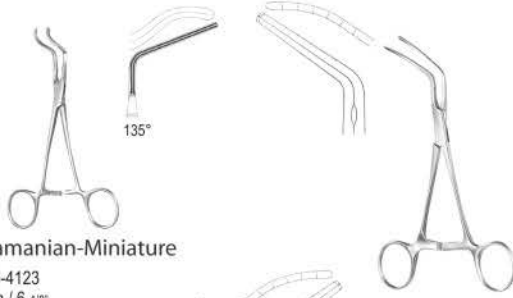

Subramanian-Miniature

PST-15-4123
16.5 cm / 6 4/8"

Subramanian
PST-15-4124
16 cm / 6 2/8"



Subramanian
PST-15-4125
16 cm / 6 2/8"

Kinder-Gefäßklemmen

Pediatric Vascular Clamps
Pinzas vasculares pediátricas
Pincés vasculaires pédiatriques
Pinze vascolari pediatriche



PST-15-4126 14 cm / 5 4/8" Fig. 1
PST-15-4127 14 cm / 5 4/8" Fig. 2
PST-15-4128 14 cm / 5 4/8" Fig. 3
PST-15-4129 14 cm / 5 4/8" Fig. 4
PST-15-4130 14 cm / 5 4/8" Fig. 5



PST-15-4131 13 cm / 5" Fig. 6
PST-15-4132 13 cm / 5" Fig. 7
PST-15-4133 14 cm / 5 4/8" Fig. 8
PST-15-4134 13 cm / 5" Fig. 9



PST-15-4126 - PST-15-4134

Kinder-Gefäßklemmen

Pediatric Vascular Clamps
Pinzas vasculares pediátricas
Pincés vasculaires pédiatriques
Pinze vascolari pediatriche



PST-15-4135
16.5 cm / 6 4/8"

PST-15-4136
16.5 cm / 6 4/8"

PST-15-4137
15.5 cm / 6"



PST-15-4138
15.5 cm / 6"

PST-15-4139
16 cm / 6 2/8"

Neonatal-Gefäßklemmen

Neonatal Vascular Clamps
Pinzas vasculares para recién nacidos
Pincés vasculaires pour nouveaux nés
Pinze vascolari per neonati



PST-15-4140
12.5 cm / 5"

PST-15-4141
12 cm / 4 6/8"

PST-15-4142
11 cm / 4 2/8"

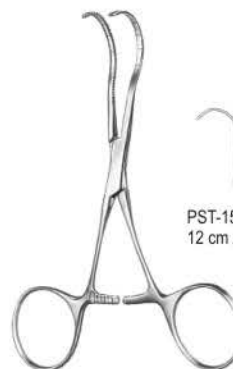

PST-15-4143
12 cm / 4 6/8"

PST-15-4144
12 cm / 4 6/8"

PST-15-4145
12 cm / 4 6/8"

PST-15-4146
12 cm / 4 6/8"

Castañeda
PST-15-4140 - PST-15-4146

Neurochirurgie
Laminektomie

Neurosurgery, Laminectomy
Neurocirugia, Laminectomia
Neurochirurgie, Laminectomie
Neurochirurgia, Laminectomia

16



Quality Instruments

Drahtsägen

Wire Saws
Sierras de hilo
Fils-scies
Fili sega

PST-16-4201
30 cm / 11 5/8"

PST-16-4202
40 cm / 15 5/8"

PST-16-4203
50 cm / 19 5/8"

PST-16-4204
60 cm / 23 5/8"

PST-16-4205
70 cm / 27 4/8"



Gigli
PST-16-4206

Drahtsägen-Handgriff
Wire Saw Handle
Mango de gancho
Manche à crochet
Manico con uncino

De Martel

PST-16-4207
33 cm / 13"

Einführinstrument
Wire Saw Guide
Conductor para sierras de hilo
Conducteur pour fils-scies
Introduttore

Gigli

PST-16-4201 - PST-16-4205

Schädelhalter

Skull Traction Tongs
Estribos de tracción craneal
Pinces de traction crânienne
Pinze per trazione craniale



Crutchfield
PST-16-4208

kleines Modell
small pattern
modelo pequeño
modèle petit
modello piccolo

Crutchfield
PST-16-4209 - 4210

mittleres Modell
medium pattern
modelo mediano
modèle moyen
modello medio

PST-16-4209
7 cm / 2 5/8"

Vorbohrer
Drill Point
Perforador
Alésoir
Alesatore
3.5 mm

PST-16-4210
7 cm / 2 5/8"

Vorbohrer
Drill Point
Perforador
Alésoir
Alesatore
5 mm



PST-16-4211

großes Modell
large pattern
modelo grande
modèle grand
modello grande

PST-16-4212

Ersatzdorn
Spare Pin
Espina de repuesto
Pointe de rechange
Punta di ricambio



Schädelzangen

Cranial Rongeurs
Pinzas sacabocados craneales
Pinces emporte-pièces crâniennes
Pinze per craniectomia

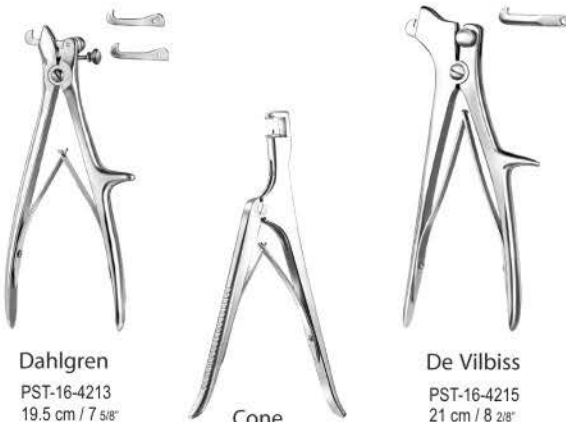

Dahlgren

PST-16-4213
19.5 cm / 7 5/8"

Cone

PST-16-4214
22.5 cm / 8 7/8"

Schädelstanze
Cranial Punch
Pinza sacabocado craneal
Pince emporte-pièces crânienne
Pinza per craniectomia

De Vilbiss

PST-16-4215
21 cm / 8 2/8"



Clips und Anlegezangen

Clips and Applying Forceps
Grapas y pinzas aplicadoras
Clips et pinces pour appliquer
Agrafes e pinze per applicare



PST-16-4216

Olivecrona-Toennis

Klammerzange
Clip Applying Forceps
Pinza para colocar grapas
Pince pour poser les agrafes en argent
Pinza per applicare le agrafe di argento

PST-16-4217

McKenzie

18.5 cm / 7 2/8"

Klammerzange
Clip Applying Forceps
Pinza clipadora
Pince pour poser les agrafes
Pinza per applicare le agrafe



Kölner

PST-16-4218

Kopfhautklammer
Scalp Clip
Grapa para cuero cabelludo
Agrafes pour cuir chevelu
Pinze per il cuoio capelluto



Raney

PST-16-4219

Kopfhautklammer
Scalp Clip
Grapa para cuero cabelludo
Agrafes pour cuir chevelu
Pinze per il cuoio capelluto

VE = 50 Stück
SU = 50/pack
UV = 50 piezas
UC = 50 unités
UV = 50 pezzi

Anlege- und Abnehmzange
Applying/Removal Forceps
Pinza para aplicar y quitar agrafes
Pince pour appliquer et enlever les
clips hémostatiques du cuir
Pinza per applicare e togliere le agrafe
emostatichae al cuoio capelluto



Raney

PST-16-4220
15.5 cm / 6"



Neurochirurgie
Laminektomie

Neurosurgery, Laminectomy
Neurocirugia, Laminectomia
Neurochirurgie, Laminektomie
Neurochirurgia, Laminectomia

16



Quality Instruments

Duradissektoren

Dura Dissectors
Disecadores para duramadre
Dissecteurs à dure-mère
Dissettori per la dura-madre

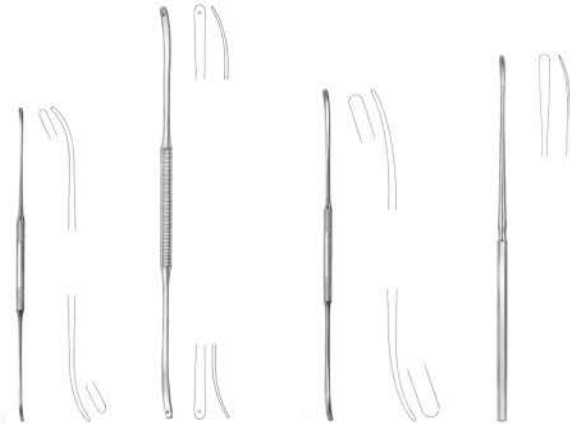

Olivecrona PST-16-4221 18 cm / 7 1/8"	Olivecrona PST-16-4222 24 cm / 9 4/8"	Olivecrona PST-16-4223 20 cm / 7 7/8"	Sachs PST-16-4224 20.5 cm / 8 1/8"
---------------------------------------------	---------------------------------------------	---------------------------------------------	------------------------------------------

Duradissektoren

Dura Dissectors
Disecadores para duramadre
Dissecteurs à dure-mère
Dissettori per la dura-madre

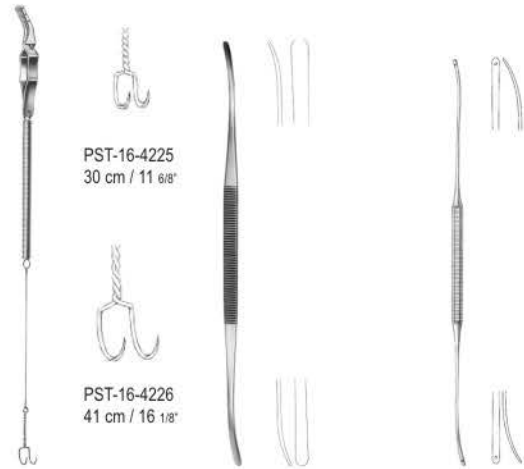

Yasargil PST-16-4225 - PST-16-4226 Galeahaken Galea hook Gancho Galea Ecarteur Galea Divaricatore Galea	Toennis PST-16-4227 24 cm / 9 4/8"	Olivecrona PST-16-4228 24 cm / 9 4/8"
---------------------------------------------------------------------------------------------------------------------------	------------------------------------------	---------------------------------------------

Duradissektoren

Dura Dissectors
Disecadores para duramadre
Dissecteurs à dure-mère
Dissettori per la dura-madre

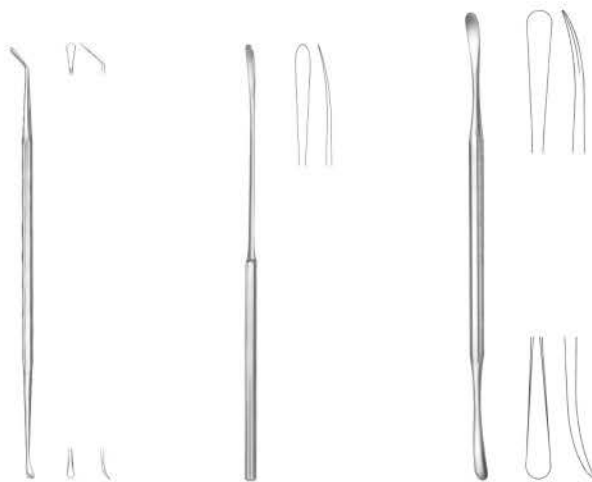

Milligan PST-16-4229 21.5 cm / 8 4/8"	Davis PST-16-4230 21.5 cm / 8 4/8"	PST-16-4231 22 cm / 8 5/8"
---------------------------------------------	------------------------------------------	-------------------------------

Duradissektoren

Dura Dissectors
Disecadores para duramadre
Dissecteurs à dure-mère
Dissettori per la dura-madre

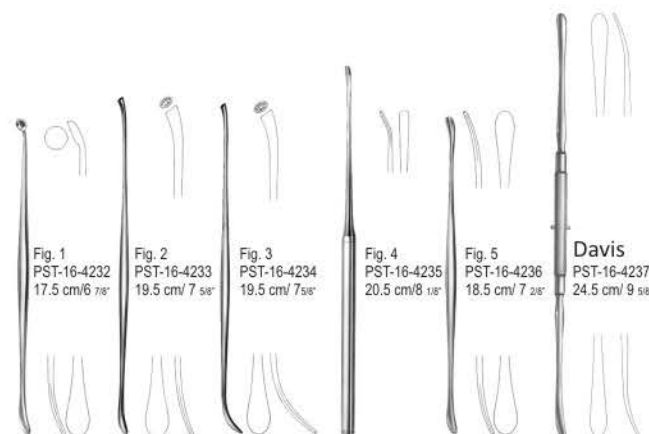

Fig. 1 PST-16-4232 17.5 cm / 6 7/8"	Fig. 2 PST-16-4233 19.5 cm / 7 5/8"	Fig. 3 PST-16-4234 19.5 cm / 7 5/8"	Fig. 4 PST-16-4235 20.5 cm / 8 1/8"	Fig. 5 PST-16-4236 18.5 cm / 7 2/8"	Davis PST-16-4237 24.5 cm / 9 5/8"
Penfield PST-16-4232 - PST-16-4236					

Neurochirurgie
Laminektomie

Neurosurgery, Laminectomy
Neurocirugia, Laminectomia
Neurochirurgie, Laminectomie
Neurochirurgia, Laminectomia

16



Quality Instruments

Nervwurzelnhaken
Nerve Root Retractors
Separadores para la raíz de nervio
Retracteurs pour racines nerveuses
Uncini per le radici die nervi

Love PST-16-4238 21.5 cm / 8 4/8"	Love PST-16-4239 17.5 cm / 6 7/8"	Love PST-16-4240 11 cm / 4 3/8"	Love PST-16-4241 21 cm / 8 2/8"
-----------------------------------------	-----------------------------------------	---------------------------------------	---------------------------------------

★★★★★

Hirnspatel
Brain Spatulas
Espátulas cerebrales
Spatules cérébrales
Spatole cerebrali

Olivecrona
konkav
concave
cóncava
concave
concava

PST-16-4242	7 + 9 mm	
PST-16-4243	11 + 13 mm	
PST-16-4244	15 + 18 mm	
PST-16-4245	18 + 22 mm	

Heifetz
PST-16-4250 - PST-16-4252
15.5 cm / 6 1/8"

PST-16-4253
15.5 cm / 6 1/8"
11 mm

PST-16-4254
20 cm / 7 7/8"
14 mm

PST-16-4255
20 cm / 7 7/8"
17 mm

PST-16-4256
20 cm / 7 7/8"
20 mm

Heifetz
PST-16-4253 - PST-16-4256

★★★★★

Nervwurzelnhaken
Nerve Root Retractors
Separadores para la raíz de nervio
Retracteurs pour racines nerveuses
Uncini per le radici die nervi

Scoville PST-16-4257 23.5 cm / 9 2/8"	Holsher PST-16-4258 24 cm / 9 4/8"	Scoville PST-16-4259 16.5 cm / 6 4/8"
---------------------------------------------	------------------------------------------	---------------------------------------------

★★★★★

Nervhaken
Nerve Hooks
Ganchos para nervios
Crochets à nerfs
Uncini per nervi

Groningen PST-16-4260 26.5 cm / 10 3/8"	Groningen PST-16-4261 26.5 cm / 10 3/8"	Cushing PST-16-4262 PST-16-4263	Cushing PST-16-4264 PST-16-4265	Smithwick PST-16-4266 PST-16-4267
-----------------------------------------------	-----------------------------------------------	---------------------------------------	---------------------------------------	-----------------------------------------

Fig. 1 PST-16-4262 19 cm / 7 4/8"
Fig. 2 PST-16-4264 19 cm / 7 4/8"
Fig. 1 PST-16-4263 28 cm / 11"
Fig. 2 PST-16-4265 28 cm / 11"
PST-16-4266 16.5 cm / 6 4/8"
PST-16-4267 21 cm / 8 4/8"

★★★★★

Neurochirurgie
Laminektomie

Neurosurgery, Laminectomy
 Neurocirugia, Laminectomia
 Neurochirurgie, Laminectomie
 Neurochirurgia, Laminectomia

16



Quality Instruments

Durahaken

Dura Hooks
 Ganchos para duramadre
 Crochets pour dure-mère
 Uncini per dura-madre

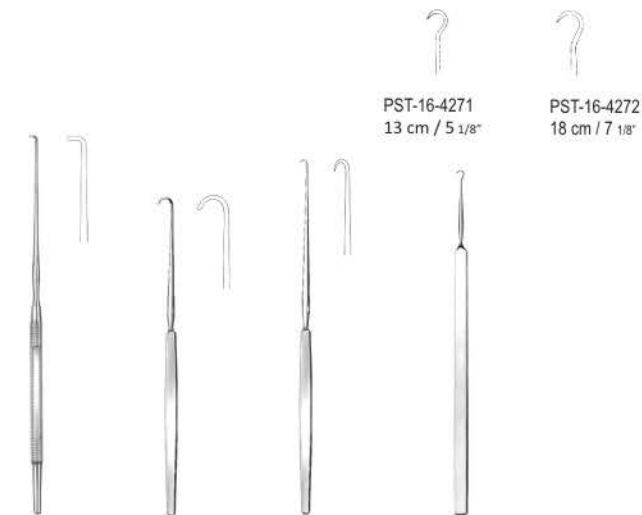

Adson
 PST-16-4268
 20 cm / 7 7/8"

Graham
 PST-16-4269
 16.5 cm / 6 4/8"

Sachs
 PST-16-4270
 17 cm / 6 6/8"

Frazier
 PST-16-4271 - PST-16-4272

PST-16-4271
 13 cm / 5 1/8"

PST-16-4272
 18 cm / 7 1/8"

Nerv- und Gefäßhäkchen

Nerve and Vessel Hooklets
 Ganchitos para nervios y vasos
 Crochets à nerfs et à vaisseaux
 Uncini per nervi e vasi

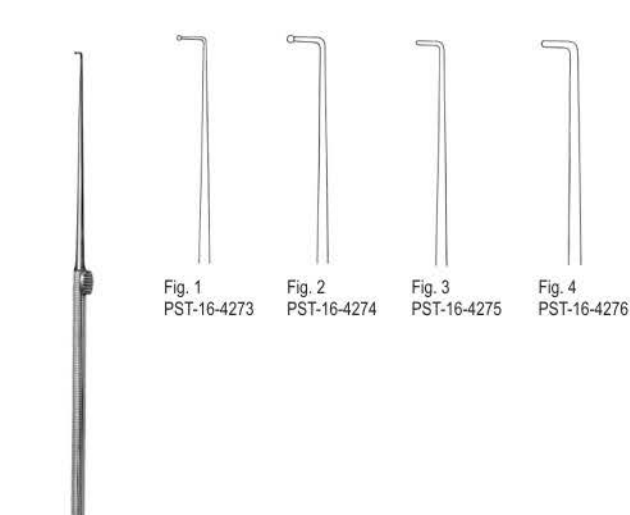

Krayenbühl
 PST-16-4273 - PST-16-4276
 19 cm / 7 4/8"

Fig. 1 PST-16-4273
 Fig. 2 PST-16-4274
 Fig. 3 PST-16-4275
 Fig. 4 PST-16-4276

Wirbelkörperspreizer

Lamina Spreaders
 Separadores para cuerpos vertebrales
 Ecarteurs pour corps vertébraux
 Separatori per vertebre

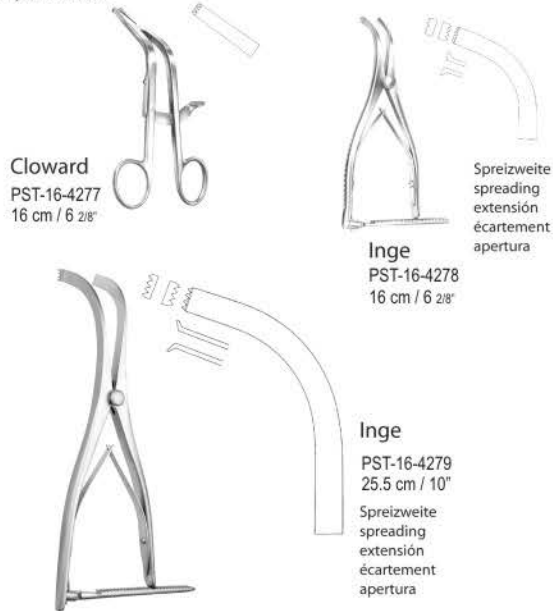

Cloward
 PST-16-4277
 16 cm / 6 2/8"

Inge
 PST-16-4278
 16 cm / 6 2/8"

Inge
 PST-16-4279
 25.5 cm / 10"

Laminektomiestanzen

Laminectomy Punches
 Pinzas cortantes para laminectomia
 Pinces emporte-pièces à laminectomie
 Pinze taglienti per laminectomia

Schaftlänge Shaft length Longitud del vástago Longueur du tige Lunghezza del gambo	150 cm / 6"	180 cm / 8"	150 cm / 6"	180 cm / 8"
Bissbreite Width of bite Anchura de la boca Largeur des mors Larghezza del morso	3 mm	3 mm	5mm	5mm
Art.-Nr. Cat. No. No. de art. N° d'article No. di art.	PST-16-4280	PST-16-4281	PST-16-4282	PST-16-4283

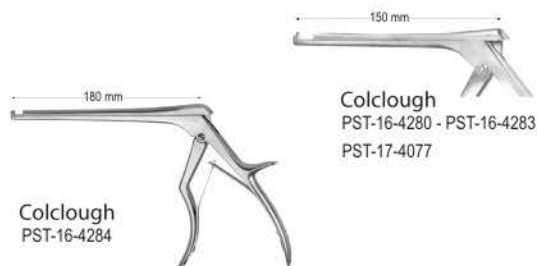

Colclough
 PST-16-4284

Colclough
 PST-16-4280 - PST-16-4283
 PST-17-4077



Laminektomiestanzen

Laminectomy PUNCHES
Pinzas cortantes para laminectomia
Pincas emporte-pièces à laminectomie
Pinze taglianti per laminectomia

Schaftlänge Shaft length Longitud del vástago Longueur du tige Lunghezza del gambo	150 mm / 6"	180 mm / 8"	150 mm / 6"	180 mm / 8"
Bisbreite Width of bite Anchura de la boca Largeur des mors Larghezza del morso	3 mm	3 mm	3 mm	5 mm
Art.-Nr. Cat. No. No. de art. N° d'article No. di art.	PST-16-4285	PST-16-4286	PST-16-4287	PST-16-4288

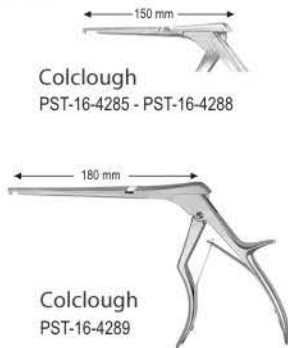

Laminektomiestanzen

Laminectomy PUNCHES
Pinzas cortantes para laminectomia
Pincas emporte-pièces à laminectomie
Pinze taglianti per laminectomia

Schaftlänge Shaft length Longitud del vástago Longueur du tige Lunghezza del gambo	150 mm / 6"	180 mm / 8"	150 mm / 6"	180 mm / 8"
Bisbreite Width of bite Anchura de la boca Largeur des mors Larghezza del morso	3 mm	3 mm	5 mm	5 mm
Art.-Nr. Cat. No. No. de art. N° d'article No. di art.	PST-16-4290	PST-16-4291	PST-16-4292	PST-16-4293

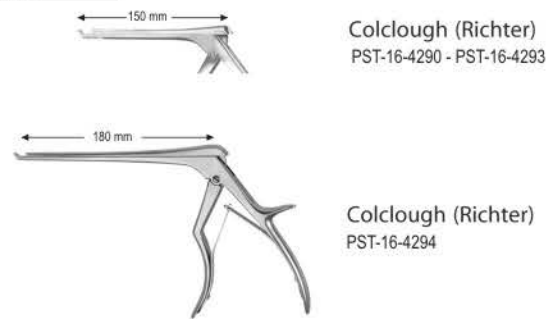

Laminektomiestanzen

Laminectomy PUNCHES
Pinzas cortantes para laminectomia
Pincas emporte-pièces à laminectomie
Pinze taglianti per laminectomia

Ferris-Smith Kerrison
PST-16-4295 - PST-16-4318

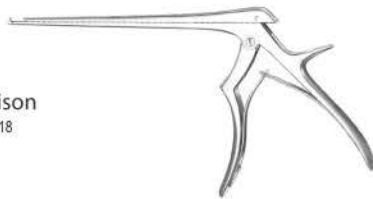

aufwärts schneidend upwards cutting	Schaftlänge shaft length	180 mm	230 mm	
	PST-16-4295	PST-16-4301	1 mm	1 mm
	PST-16-4296	PST-16-4302	2 mm	2 mm
	PST-16-4297	PST-16-4303	3 mm	3 mm
	PST-16-4298	PST-16-4304	4 mm	4 mm
	PST-16-4299	PST-16-4305	5 mm	5 mm
	PST-16-4300	PST-16-4306	6 mm	6 mm
downwards cutting	shaft length	180 mm	230 mm	
	PST-16-4307	PST-16-4313	1 mm	1 mm
	PST-16-4308	PST-16-4314	2 mm	2 mm
	PST-16-4309	PST-16-4315	3 mm	3 mm
	PST-16-4310	PST-16-4316	4 mm	4 mm
	PST-16-4311	PST-16-4317	5 mm	5 mm
	PST-16-4312	PST-16-4318	6 mm	6 mm

Laminektomiestanzen

Laminectomy PUNCHES
Pinzas cortantes para laminectomia
Pincas emporte-pièces à laminectomie
Pinze taglianti per laminectomia

Ferris-Smith Kerrison
PST-16-4319 - PST-16-4342

zerlegbar
demountable
plegable
démontable
smontabile



aufwärts schneidend upwards cutting cortante hacia arriba tranchant vers le haut tagliante in alto	Schaftlänge shaft length longitud del vástago longueur du tige lunghezza del gambo	180 mm	230 mm	nach oben schneidend upwards cutting cortante hacia arriba tranchant vers le haut tagliante in alto 40°	Schaftlänge shaft length longitud del vástago longueur du tige lunghezza del gambo	180 mm	230 mm		
	PST-16-4319	PST-16-4325	1 mm	1 mm		PST-16-4331	PST-16-4337	1 mm	1 mm
	PST-16-4320	PST-16-4326	2 mm	2 mm		PST-16-4332	PST-16-4338	2 mm	2 mm
	PST-16-4321	PST-16-4327	3 mm	3 mm		PST-16-4333	PST-16-4339	3 mm	3 mm
	PST-16-4322	PST-16-4328	4 mm	4 mm		PST-16-4334	PST-16-4340	4 mm	4 mm
	PST-16-4323	PST-16-4329	5 mm	5 mm		PST-16-4335	PST-16-4341	5 mm	5 mm
	PST-16-4324	PST-16-4330	6 mm	6 mm		PST-16-4336	PST-16-4342	6 mm	6 mm

Neurochirurgie
Laminektomie

Neurosurgery, Laminectomy
Neurocirugia, Laminectomia
Neurochirurgie, Laminectomie
Neurochirurgia, Laminectomia

16



Quality Instruments

Laminektomiestanzen

Laminectomy Punches
Pinzas cortantes para laminectomia
Pincas emporte-pièces à laminectomie
Pinze taglianti per laminectomia



Schaftlänge
shaft length
longitud del vástago
longueur du tige
lunghezza del gambo

Cushing Straight	2 x 10 mm	Cushing upwards	2 x 10 mm	Cushing downwards	2 x 10 mm
PST-16-4343	120 mm	PST-16-4346	120 mm	PST-16-4349	120 mm
PST-16-4344	150 mm	PST-16-4347	150 mm	PST-16-4350	150 mm
PST-16-4345	180 mm	PST-16-4348	180 mm	PST-16-4351	180 mm
Love Grenwald Straight	3 x 10 mm	Love Grenwald upwards	3 x 10 mm	Love Grenwald downwards	3 x 10 mm
PST-16-4352	120 mm	PST-16-4355	120 mm	PST-16-4358	120 mm
PST-16-4353	150 mm	PST-16-4356	150 mm	PST-16-4359	150 mm
PST-16-4354	180 mm	PST-16-4357	180 mm	PST-16-4360	180 mm
Spurling Straight	4 x 10 mm	Spurling upwards	4 x 10 mm	Spurling downwards	4 x 10 mm
PST-16-4361	120 mm	PST-16-4364	120 mm	PST-16-4367	120 mm
PST-16-4362	150 mm	PST-16-4365	150 mm	PST-16-4368	150 mm
PST-16-4363	180 mm	PST-16-4366	180 mm	PST-16-4369	180 mm

Laminektomieezangen

Laminectomy Rongeurs
Pinzas para laminectomia
Pincas pour laminectomie
Pinze per laminectomia



PST-16-4370
27 cm / 10 3/4"
Ø 8,0 mm

Schaftlänge
shaft length
longitud del vástago
longueur du tige
lunghezza del gambo
180 mm



PST-16-4371
25 cm / 9 3/4"
Ø 8.0 mm

Schaftlänge
shaft length
longitud del vástago
longueur du tige
lunghezza del gambo
185 mm

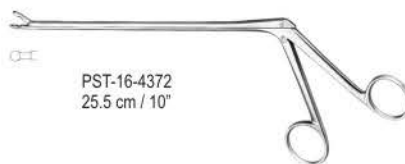

PST-16-4372
25.5 cm / 10"

Schaftlänge
shaft length
longitud del vástago
longueur du tige
lunghezza del gambo
200 mm



Tracheotomie

Tracheotomy
Traqueotomia
Trachéotomie
Trachéotomia

17

Trachealdilatatoren

Tracheal Dilators
Dilatadores traqueales
Dilatateurs pour la trachéotomie
Dilatatori per tracheotomia



Laborde
PST-17-4401
14 cm / 5 4/8"



Trousseau
PST-17-4402
14.5 cm / 5 6/8"

Trachealhaken

Tracheal Hooks
Ganchos traqueales
Ecarteurs pour trachéotomie
Uncini tracheali



PST-17-4403
17 cm / 6 6/8"
scharf
sharp
agudo
pointu
acuto



PST-17-4404
17 cm / 6 6/8"
stumpf
blunt
romo
mousse
smusso



Rose
PST-17-4405
15.5 cm / 6 1/8"

Iterson

PST-17-4403 - PST-17-4404



Luer
PST-17-4406
11 cm / 4 3/8"



Lukens
PST-17-4407
17.5 cm / 6 7/8"



Tracheotomie

Tracheotomy
Traqueotomía
Trachéotomie
Trachéotomia

17



Quality Instruments

Trachealhaken

Tracheal Hooks
Ganchos traqueales
Ecarteurs pour trachéotomie
Uncini tracheali

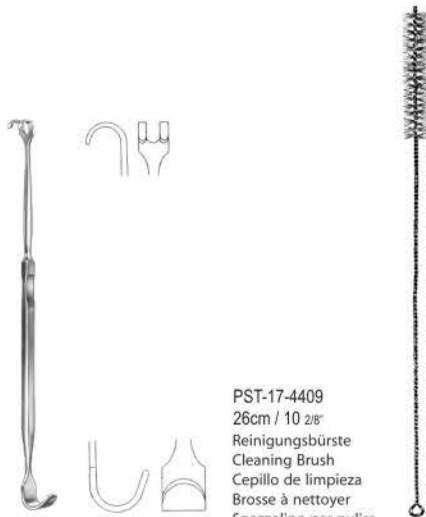

PST-17-4409
26cm / 10 2/8"
Reinigungsbürste
Cleaning Brush
Cepillo de limpieza
Brosse à nettoyer
Spazzolino per pulire

für Trachealkanülen, Bürstenkopf Ø 12 mm
for tracheal tubes, head of brush Ø 12 mm
para cánulas traqueales, cabeza del cepillo Ø 12 mm
pour canules trachéales, tête du brosse Ø 12 mm
per cannule tracheali, testa di spazzolino Ø 12 mm

Jackson

PST-17-4408
18cm / 7 1/8"

Kropfsonden

Goitre Enucleator
Sondas para bocio
Spatules à goitre
Sonde per gozzo

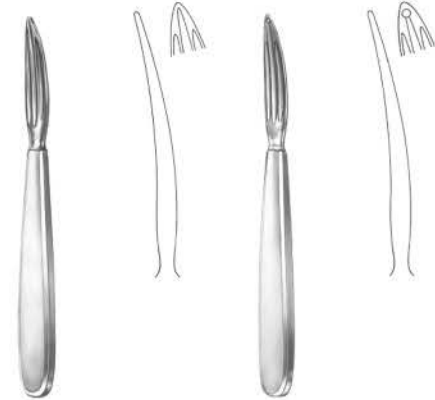

Kocher

PST-17-4410
15,5 cm / 6 1/8"

Kocher

PST-17-4411
15,5 cm / 6 1/8"

mit Loch
with eye
con agujero
avec trou
con foro



Trachealkanülen

Tracheal Tubes
Cánulas traqueales
Canules tracheales
Cannule tracheali



Fig	Ø	L	Material
0	4 mm	45 mm	Ag PST-17-4412
			G5 PST-17-4413
1	5 mm	50 mm	Ag PST-17-4414
			G5 PST-17-4415
2	6 mm	55 mm	Ag PST-17-4416
			G5 PST-17-4417
3	7 mm	60 mm	Ag PST-17-4418
			G5 PST-17-4419
4	8 mm	65 mm	Ag PST-17-4420
			G5 PST-17-4421
5	9 mm	70 mm	Ag PST-17-4422
			G5 PST-17-4423
6	10 mm	75 mm	Ag PST-17-4424
			G5 PST-17-4425
7	11 mm	80 mm	Ag PST-17-4426
			G5 PST-17-4427
8	12 mm	85 mm	Ag PST-17-4428
			G5 PST-17-4429
9	13 mm	90 mm	Ag PST-17-4430
			G5 PST-17-4431

Luer

Außenrohr Sieb
Innenrohr Fenster
outer tube sieve
inner tube window
tubo exterior tamiz
tubo interior ventana
canule externe tamis
canule interne fenêtre
cannula esterna crivello
cannula interna apertura

Trachealkanülen

Tracheal Tubes
Cánulas traqueales
Canules tracheales
Cannule tracheali



Radius	Fig	Ø	L	Material
N	3	7 mm	60 mm	Ag PST-17-4432
				G5 PST-17-4433
N	4	8 mm	65 mm	Ag PST-17-4434
				G5 PST-17-4435
N	5	9 mm	70 mm	Ag PST-17-4436
				G5 PST-17-4437
N	6	10 mm	75 mm	Ag PST-17-4438
				G5 PST-17-4439
N	7	11 mm	80 mm	Ag PST-17-4440
				G5 PST-17-4441
N	8	12 mm	85 mm	Ag PST-17-4442
				G5 PST-17-4443
N	9	13 mm	90 mm	Ag PST-17-4444
				G5 PST-17-4445

Luer

Außenrohr Sieb
Innenrohr Sieb
outer tube sieve
inner tube sieve
tubo exterior tamiz
tubo interior tamiz
canule externe tamis
canule interne tamis
cannula esterna crivello
cannula interna crivello



Dermatologie
Dermatology
Dermatología
Dermatologie
Dermatologia



18

147

Magen,Darm Rektum
Stomach,intestines,Rectum
Estómago,intestinos,Recto
Estomac,intestins,Rectum
Stomaco,intestini,Retto



19

148 - 154

Urologie
Urology
Urología
Urologie
Urologia

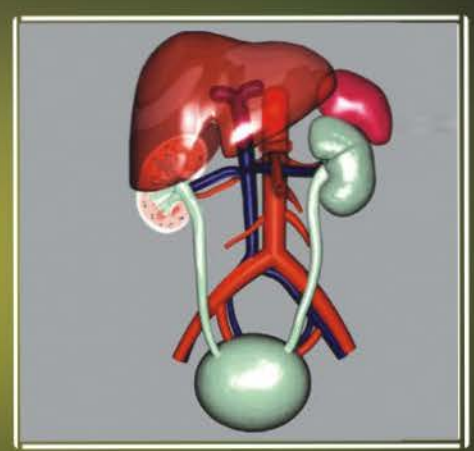

20

155 - 158

Dermatologie

Dermatology
Dermatologia
Dermatologie
Dermatologia

18



Quality Instruments

Milienmesser, Lupusinstrumente

Millium Knife, Lupus Instruments
Chuchillo para milium, Instrumentos para lupus
Couteau pour milium, Instruments pour les lupus
Bisturi per milie, Strumenti per lupus

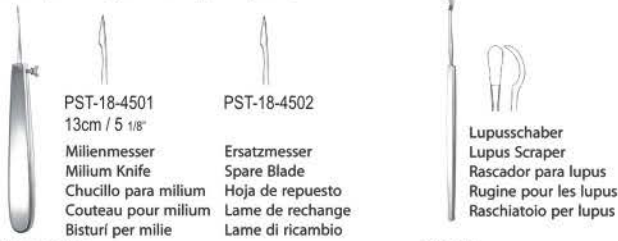

PST-18-4501
13cm / 5 1/8"

PST-18-4502

Milienmesser
Millium Knife
Chuchillo para milium
Couteau pour milium
Bisturi per milie

Ersatzmesser
Spare Blade
Hoja de repuesto
Lame de rechange
Lame di ricambio

Lupusschaber
Lupus Scraper
Rascador para lupus
Rugine pour les lupus
Raschiatoio per lupus

Moncorps

PST-18-4501 - PST-18-4502

Vidal

PST-18-4503
13cm / 5 1/8"

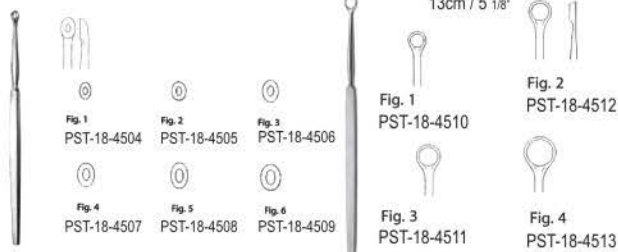

Fig. 1
PST-18-4504

Fig. 2
PST-18-4505

Fig. 3
PST-18-4506

Fig. 4
PST-18-4507

Fig. 5
PST-18-4508

Fig. 6
PST-18-4509

Fig. 1
PST-18-4510

Fig. 2
PST-18-4512

Fig. 3
PST-18-4511

Fig. 4
PST-18-4513

Wolff

PST-18-4504 - PST-18-4509
14 cm / 5 4/8"

Fox

PST-18-4510 - PST-18-4513
14 cm / 5 4/8"

Hauthäkchen, Hautrephinen

Skin Hooklets, Dermal Punctures
Ganchitos para piel, Trépanos para piel
Erignes cutanées, Trépan cutanéés
Uncini cutanei, Trefine cutanee

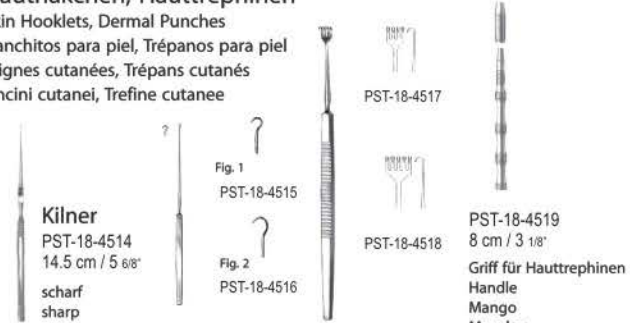

Kilner
PST-18-4514
14,5 cm / 5 6/8"
scharf
sharp
agudo
pointu
acuto

Fig. 1
PST-18-4515

Fig. 2
PST-18-4516

PST-18-4517

PST-18-4518

PST-18-4519
8 cm / 3 1/8"
Griff für Hautrephinen
Handle
Mango
Manche
Manico

Gillies
PST-18-4515 - 4516
18 cm / 7 1/8"

Kaye
PST-18-4517 - PST-18-4518
13 cm / 5 1/8"

Hautrephine

Dermal Punctures
Trépanos para piel
Trépan cutanéés
Trefine cutanee

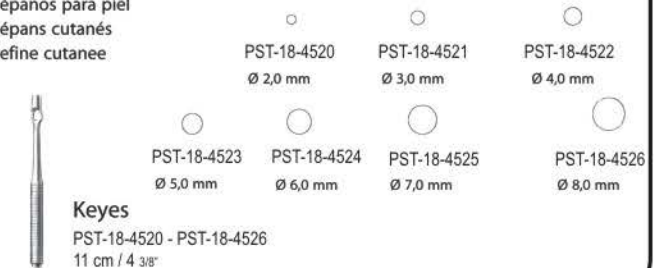

PST-18-4520
Ø 2,0 mm

PST-18-4521
Ø 3,0 mm

PST-18-4522
Ø 4,0 mm

PST-18-4523
Ø 5,0 mm

PST-18-4524
Ø 6,0 mm

PST-18-4525
Ø 7,0 mm

PST-18-4526
Ø 8,0 mm

Keys

PST-18-4520 - PST-18-4526
11 cm / 4 3/8"

Komedoneninstrumente

Comedone Extractors
Extractores para comedones
Tire-comédons
Tiracomedoni

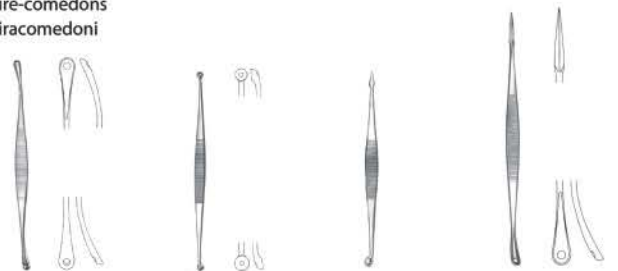

Unna

PST-18-4527
14,5 cm / 5 6/8"

Unna

PST-18-4528
14,5 cm / 5 4/8"

Saalfeld

PST-18-4529
11 cm / 4 3/8"

Saalfeld

PST-18-4530
14,5 cm / 5 6/8"

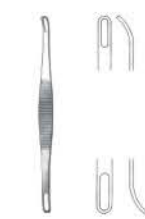

Schamberg

PST-18-4531
9,5 cm / 3 6/8"



Katsch

PST-18-4532
16cm / 6 2/8"



Unna-Vidal

PST-18-4533
11 cm / 4 3/8"

Face-Lift-Klemmen, Face-Lift-Scheren

Face-lift Forceps, Face-lift Scissors
Pinza para Face-lift, Tijeras para Face-lift
Pinces pour Face-lift, Ciseaux pour Face-lift
Pinze per Face-lift, Forbici per Face-lift



Gregory
PST-18-4534
14,5 cm / 5 6/8"



Kaye
PST-18-4535 - 4536
eine Schneide gezahnt
one toothed cutting edge
una hoja dentada
una lama dentada



Stella-S
PST-18-4537



d'Assumpção
PST-18-4538
16 cm 6 2/8"



Gorney
PST-18-4539
17,5 cm / 6 6/8"



Freeman-Kaye
PST-18-4540
18 cm / 7"



Freeman
PST-18-4541
23 cm / 9"

Magen, Darm
Rektum

Stomach, intestines, Rectum
Estómago, intestinos, Recto
Estomac, intestins, Rectum
Stomaco, intestini, Retto

19



Quality Instruments

Darm- und Gewebefassungen

Intestinal and Tissue Grasping Forceps

Pinzas para intestinos y tejidos

Pinces pour saisir intestins et tissus

Pinze per afferrare intestino e tessuti



Allis-Baby

PST-19-4601
13 cm / 5 1/8"

Allis

PST-19-4602 - PST-19-4605



Allis

PST-19-4606 - PST-19-4609



Darm- und Gewebefassungen

Intestinal and Tissue Grasping Forceps

Pinzas para intestinos y tejidos

Pinces pour saisir intestins et tissus

Pinze per afferrare intestino e tessuti



Allis-Adair

PST-19-4610
16 cm / 6 2/8"

Boys-Allis

PST-19-4611
15,5 cm / 6"

Judd-Allis

PST-19-4612 - PST-19-4613



Thoms-Allis

PST-19-4614
20,5 cm / 8 1/8"

Allis

PST-19-4615
20,5 cm / 7 7/8"

Lockwood

PST-19-4616
20,5 cm / 7 7/8"



Darm- und Gewebefassungen

Intestinal and Tissue Grasping Forceps

Pinzas para intestinos y tejidos

Pinces pour saisir intestins et tissus

Pinze per afferrare intestino e tessuti



Williams

PST-19-4617
16,5 cm / 6 4/8"

Babcock

PST-19-4618 - PST-19-4619



Darm- und Gewebefassungen

Intestinal and Tissue Grasping Forceps

Pinzas para intestinos y tejidos

Pinces pour saisir intestins et tissus

Pinze per afferrare intestino e tessuti

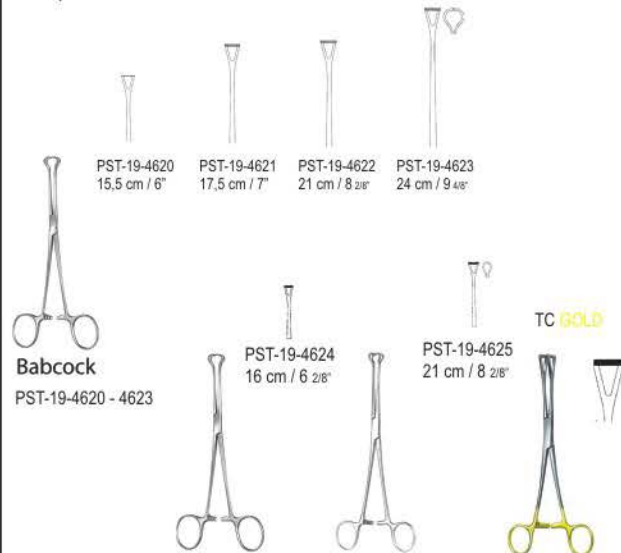

Babcock

PST-19-4620 - 4623

Babcock

PST-19-4624 - PST-19-4625

Duval

PST-19-4626
20,5 cm / 8"



Magen,Darm
Rektum

Stomach,intestines,Rectum
Estómago,intestinos,Recto
Estomac,intestins,Rectum
Stomaco,intestini,Retto

19



Quality Instruments

Darm- und Gewebefasszangen, Darmklemmen

Intestinal and Tissue Grasping Forceps, Intestinal Clamps
Pinzas para intestinos y tejidos, Pinzas intestinales
Pinces pour saisir intestins et tissus, Pinces intestinales
Pinze per afferrare intestino e tessuti, Pinze intestinali

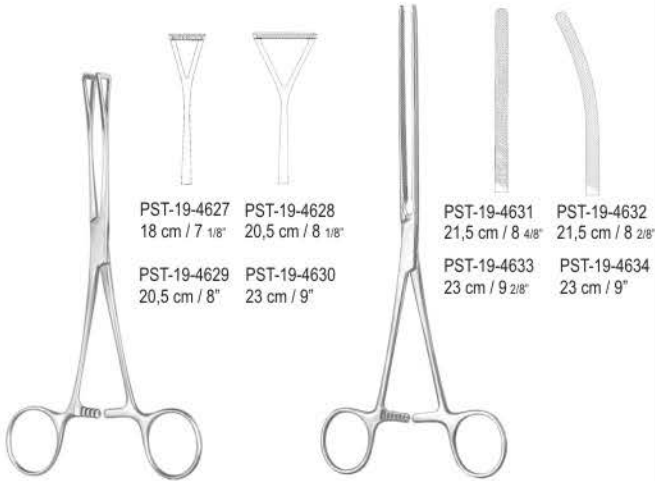

PST-19-4627 18 cm / 7 1/8"
PST-19-4628 20,5 cm / 8 1/8"

PST-19-4629 20,5 cm / 8"
PST-19-4630 23 cm / 9"

PST-19-4631 21,5 cm / 8 4/8"
PST-19-4632 21,5 cm / 8 2/8"

PST-19-4633 23 cm / 9 2/8"
PST-19-4634 23 cm / 9"

Duval
PST-19-4627 - PST-19-4630

Doyen
PST-19-4631 - PST-19-4634

Darmklemmen

Intestinal Clamps
Pinzas intestinales
Pinces intestinales
Pinze intestinali

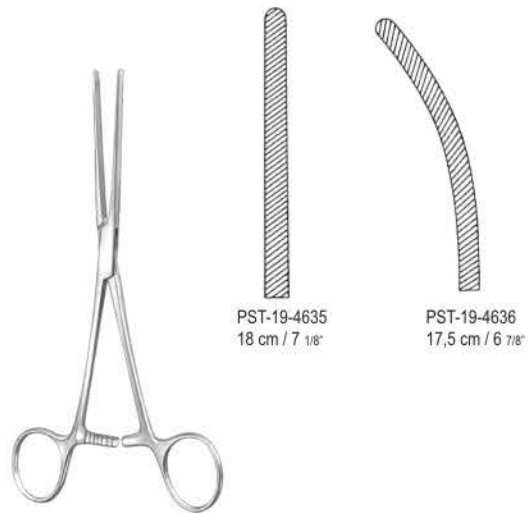

PST-19-4635
18 cm / 7 1/8"

PST-19-4636
17,5 cm / 6 7/8"

Doyen-Baby
PST-19-4635 - PST-19-4636

Darmklemmen

Intestinal Clamps
Pinzas intestinales
Pinces intestinales
Pinze intestinali

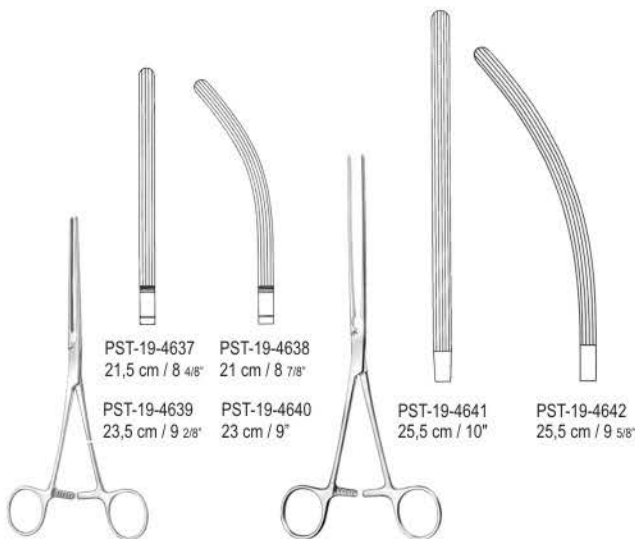

PST-19-4637 21,5 cm / 8 4/8"
PST-19-4638 21 cm / 8 7/8"

PST-19-4639 23,5 cm / 9 2/8"
PST-19-4640 23 cm / 9"

PST-19-4641 25,5 cm / 10"
PST-19-4642 25,5 cm / 9 5/8"

Mayo-Robson
PST-19-4637 - PST-19-4640

Mayo-Robson
PST-19-4641 - PST-19-4642

Darmklemmen

Intestinal Clamps
Pinzas intestinales
Pinces intestinales
Pinze intestinali

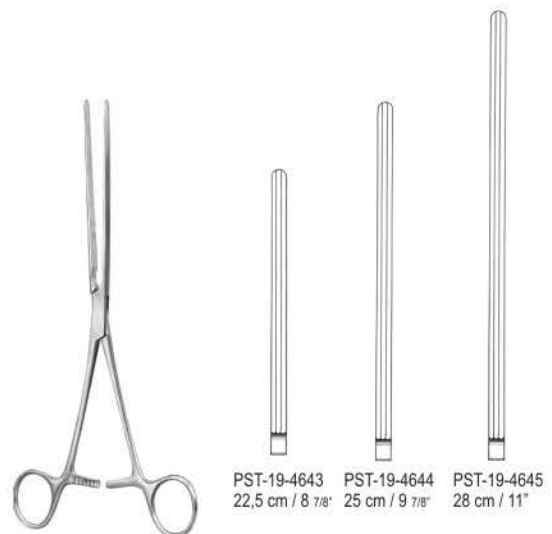

PST-19-4643
22,5 cm / 8 7/8"

PST-19-4644
25 cm / 9 7/8"

PST-19-4645
28 cm / 11"

Kocher
PST-19-4643 - PST-19-4645

Magen, Darm
Rektum

Stomach, intestines, Rectum
Estómago, intestinos, Recto
Estomac, intestins, Rectum
Stomaco, intestini, Retto

19



Quality Instruments

Darmklemmen

Intestinal Clamps
Pinzas intestinales
Pincas intestinales
Pinze intestinali



PST-19-4646 22 cm / 8 5/8"
PST-19-4647 25 cm / 9 7/8"
PST-19-4648 27.5 cm / 10 6/8"

1:2

Kocher

PST-19-4646 - PST-19-4648

Allen

PST-19-4649
16 cm / 6 2/8"



Darmquetschklemmen

Intestinal and Pylorus Clamps
Pinzas intestinales para piloro
Ecraseurs pour intestin
Schiacciatori intestinali



Payr-Baby

PST-19-4650
15 cm / 5 7/8"
mit Stift
with pin
con espiga
avec cheville
con perno

Payr

PST-19-4651 - PST-19-4653

mit Stift
with pin
con espiga
avec cheville
con perno

PST-19-4651
21 cm / 8 2/8"

PST-19-4652
29 cm / 11 3/8"

PST-19-4653
34 cm / 13 3/8"



Magen- und Darm-Zwillingsklemmen

Stomach and Intestinal Anastomosis Twin Clamps
Pinzas gastro-intestinales gemales
Pincas stomacales et intestinales jumelées
Pinze gastrointestinali gemelle

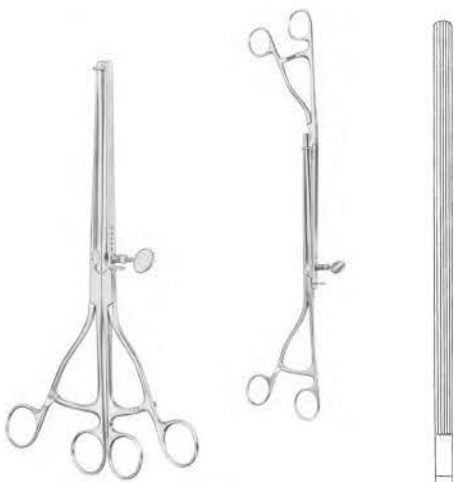

Lane

PST-19-4654
30 cm / 11 6/8"



Magen- und Darm-Zwillingsklemmen

Stomach and Intestinal Anastomosis Twin Clamps
Pinzas gastro-intestinales gemales
Pincas stomacales et intestinales jumelées
Pinze gastrointestinali gemelle

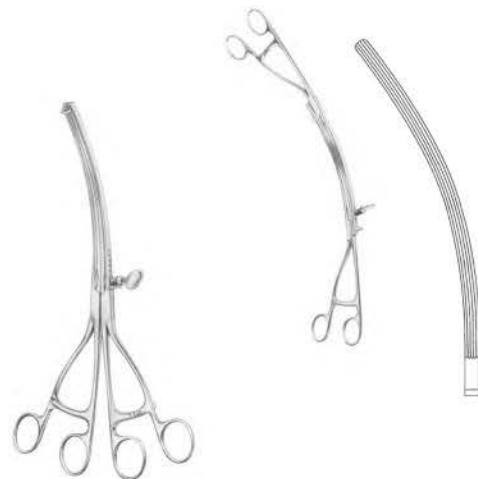

Lane

PST-19-4655
30 cm / 11 6/8"



Magen, Darm
Rektum

Stomach, intestines, Rectum
Estómago, intestinos, Recto
Estomac, intestins, Rectum
Stomaco, intestini, Retto

19



Quality Instruments

Organfasszangen

Organ Grasping Forceps
Pinzas para coger órganos
Pincers pour saisir des organes
Pinze per afferrare organi

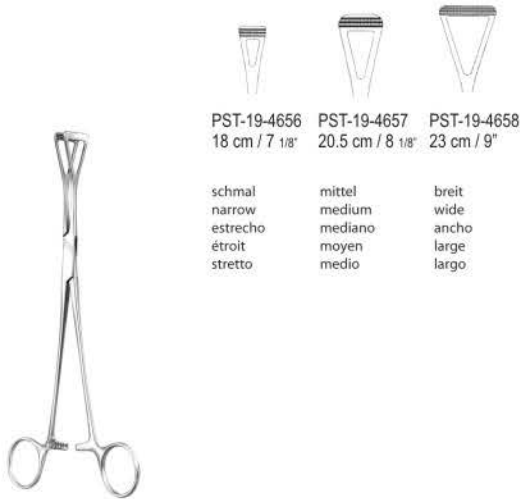

PST-19-4656 18 cm / 7 1/8"
PST-19-4657 20.5 cm / 8 1/8"
PST-19-4658 23 cm / 9"

schmal	mittel	breit
narrow	medium	wide
estrecho	mediano	ancho
étroit	moyen	large
stretto	medio	largo

Scheibe
PST-19-4656 - PST-19-4658

Darmklemmen

Intestinal Clamps
Pinzas intestinales
Pincers intestinales
Pinze intestinali

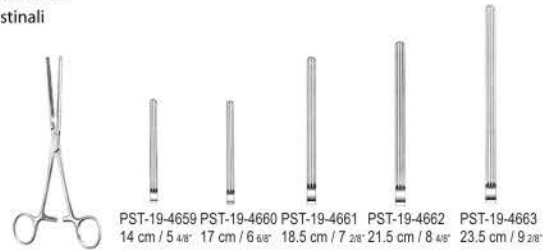

PST-19-4659 14 cm / 5 4/8"
PST-19-4660 17 cm / 6 6/8"
PST-19-4661 18.5 cm / 7 2/8"
PST-19-4662 21.5 cm / 8 4/8"
PST-19-4663 23.5 cm / 9 2/8"

Doyen-Baby
PST-19-4659 - PST-19-4663

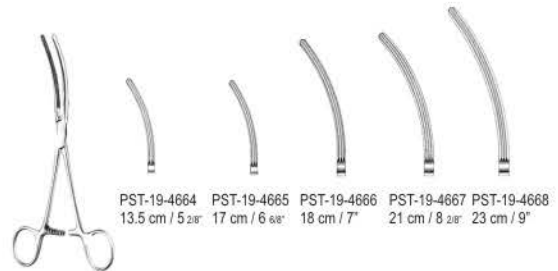

PST-19-4664 13.5 cm / 5 2/8"
PST-19-4665 17 cm / 6 6/8"
PST-19-4666 18 cm / 7"
PST-19-4667 21 cm / 8 2/8"
PST-19-4668 23 cm / 9"

Doyen-Baby
PST-19-4664 - PST-19-4668

Darmklemmen

Intestinal Clamps
Pinzas intestinales
Pincers intestinales
Pinze intestinali

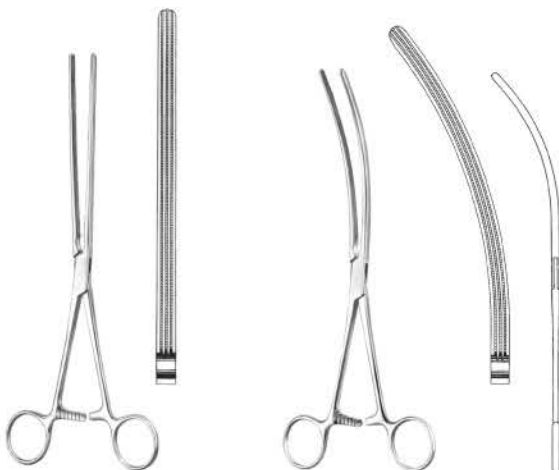

Mayo-Robson
PST-19-4669
26 cm / 10 2/8"

Mayo-Robson
PST-19-4670
25 cm / 9 2/8"

Darmklemmen

Intestinal Clamps
Pinzas intestinales
Pincers intestinales
Pinze intestinali

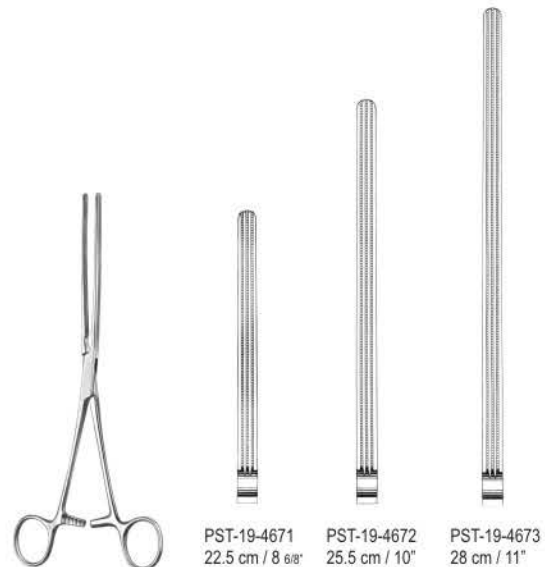

PST-19-4671 22.5 cm / 8 6/8"
PST-19-4672 25.5 cm / 10"
PST-19-4673 28 cm / 11"

Kocher
PST-19-4671 - PST-19-4673

Magen, Darm
Rektum

Stomach, intestines, Rectum
Estómago, intestinos, Recto
Estomac, intestins, Rectum
Stomaco, intestini, Retto

19



Quality Instruments

Darmklemmen

Intestinal Clamps
Pinzas intestinales
Pincas intestinales
Pinze intestinali

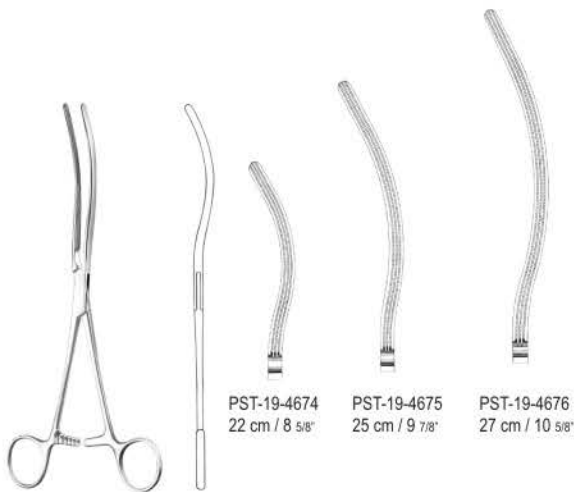

PST-19-4674
22 cm / 8 5/8"

PST-19-4675
25 cm / 9 7/8"

PST-19-4676
27 cm / 10 5/8"

Kocher

PST-19-4674 - PST-19-4676



Darmklemmen

Intestinal Clamps
Pinzas intestinales
Pincas intestinales
Pinze intestinali



PST-19-4677
33.5 cm / 13 2/8"

PST-19-4678
32.5 cm / 12 6/8"

Scudder

PST-19-4677 - PST-19-4678

Brunner

PST-19-4679
27 cm / 10 6/8"



Rektum-Anastomosenklemmen

Sigmoid Anastomosis Forceps
Pinzas para anastomosis rectales
Pincas pour anastomoses rectales
Pinze per anastomosi rettali

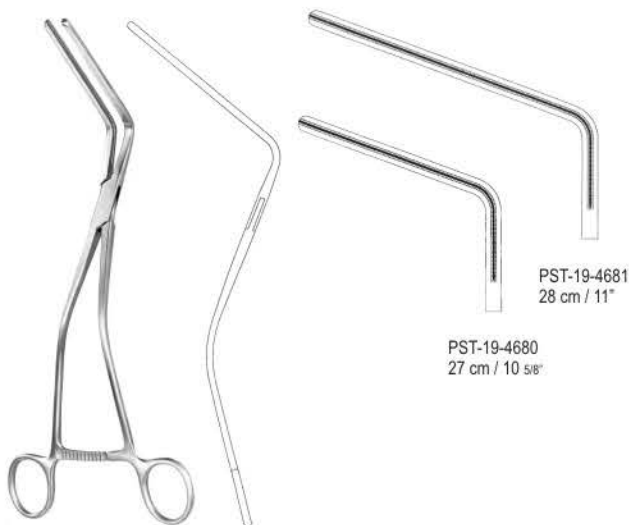

PST-19-4680
27 cm / 10 5/8"

PST-19-4681
28 cm / 11"

Hayes

PST-19-4680 - PST-19-4681



Rektum-Anastomosenklemmen

Sigmoid Anastomosis Forceps
Pinzas para anastomosis rectales
Pincas pour anastomoses rectales
Pinze per anastomosi rettali



Veidenheimer

PST-19-4682
25 cm / 9 6/8"

Fehland

PST-19-4683
24 cm / 9 4/8"



Magen,Darm
Rektum

Stomach,intestines,Rectum
Estómago,intestinos,Recto
Estomac,intestins,Rectum
Stomaco,intestini,Retto

19



Quality Instruments

Rektum-Anastomosenklemmen

Sigmoid Anastomosis Forceps
Pinzas para anastomosis rectales
Pincers pour anastomoses rectales
Pinze per anastomosi rettali



Resano
PST-19-4684
28 cm / 11"

Mastdarmspekula

Rectal Specula
Espéculos rectales
Spéculum rectaux
Specoli rettali



Czerny
PST-19-4685
22.5 cm / 8 7/8"



Sims
PST-19-4686
15.5 cm / 6 1/8"



Sims
PST-19-4687
15.5 cm / 6 1/8"

Anuskop

Anuscope
Anoscopio
Anuscope
Anuscopio

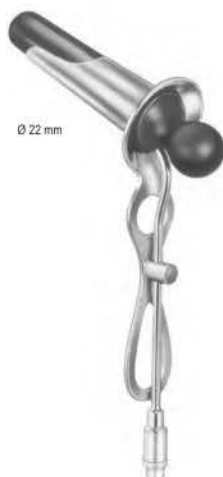

Ives-Fansler
PST-19-4688

Arbeitslänge
working length
largo útil
longueur utile
lunghezza utile
80 mm

Analspreizer

Rectal Spreaders
Separadores rectales
Ecarteurs rectaux
Divaricatori rettali



Alan-Parks
PST-19-4689 - PST-19-4694

PST-19-4689
14 cm / 5 4/8"

ohne Kaltlichtaufsatz
without F.O. light carrier
sin portador de luz fría
sans support lumière froide
senza supporto per luce fredda



Flügelmutter
Wing nut
Tuerca de mariposa
Ecrou à oreilles
Madrevite ad alette
PST-19-4694

paar Seitenvalve
Lateral Blade
Valva lateral
Valve laterale
Valva laterale
PST-19-4693

Seitenvalven
Lateral Blades
Valvas laterales
Valves laterales
Valve laterali
PST-19-4692

Mittelvalven
Central Blades
Valvas centrales
Valves centrales
Valve centrali
PST-19-4691

PST-19-4690
14 cm / 5 4/8"

mit Kaltlichtaufsatz
with F.O. light carrier
con portador de luz fría
avec support lumière froide
con supporto per luce fredda

Kaltlichtaufsatz
F.O. light carrier
Portador de luz fría
Support lumière froide
Supporto per luce fredda

Magen, Darm
Rektum

Stomach, intestines, Rectum
Estómago, intestinos, Recto
Estomac, intestins, Rectum
Stomaco, intestini, Retto

19



Quality Instruments

Sphinkteroskope, Hämorrhoidal-Ligator

Sphincteroscopes, Hemorrhoidal Ligator
Esfincteroscopios, Ligador para hemorroides
Sphinctérosopes, Ligateur pour h'morroides
Sfincteroscopi, Legatore emorroidale



Kelly
PST-19-4695 - PST-19-4696

PST-19-4695
Ø 21 mm
Arbeitslänge
working length
largo útil
longueur utile
lunghezza utile
50 mm

PST-19-4696
Ø 27 mm
Arbeitslänge
working length
largo útil
longueur utile
lunghezza utile
50 mm



PST-19-4698
Ladekonus
Loading Cone
Cono de carga
Cône de charge
Cono per caricare



Rudd
PST-19-4697 - PST-19-4699

PST-19-4699
27.5 cm / 10 7/8"
komplett mit Ladekonus
complete with loading cone
completo con cono de carga
complet avec cône de charge
completo con cono per caricare



PST-19-4697
Ligatur-Gummiringe
Rubber Rings
Anillos de goma
Anneaux en caoutchouc
Anelli di gomma

Packung mit 100 Stück
package of 100 pieces
paquete con 100 piezas
paquet avec 100 pièces
confezione di 100 pezzi

Hämorrhoidal-Faßzange

Hemorrhoidal Ligator
Ligador para hemorroides
Ligateur pour hémorroides
Legatore emorroidale

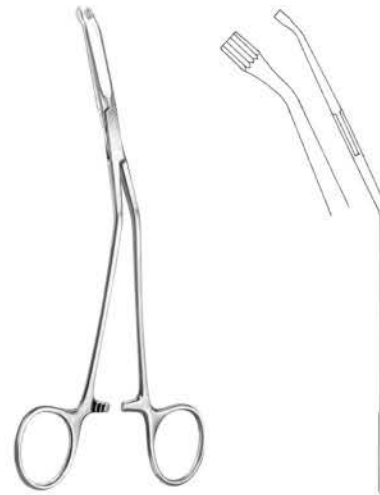

McGinvey
PST-19-4700
19 cm / 7 4/8"

Rektum-Biopsiefasszangen

Rectal Biopsy Forceps
Pinzas para biopsia rectal
Pincers pour biopsie rectale
Pinze per biopsia rettale



PST-19-4701

Biopsiezangengriff
Handle for biopsy forceps
Mango para pinza de biopsia rectal
Manche pour pince pour biopsie rectale
Manico per pinza per biopsia rettale



Fig. 1
PST-19-4702
42 cm / 16 4/8"



Fig. 2
PST-19-4703
42 cm / 16 4/8"



Fig. 3
PST-19-4704 PST-19-4702 - PST-19-4706



Fig. 4
PST-19-4705
42 cm / 16 4/8"
drehbar
rotatable
giratorio
rotatif
girevole



Fig. 5
PST-19-4706
42 cm / 16 4/8"

Rektum-Biopsiefasszangen

Rectal Biopsy Forceps
Pinzas para biopsia rectal
Pincers pour biopsie rectale
Pinze per biopsia rettale



PST-19-4707
38 cm / 15"

Maulbreite
Jaw width
Anchura de la boca
Largeur de mors
Larghezza della bocca
15 mm



Nierensteinzangen

Kidney Stone Forceps
Pinzas para cálculos renales
Pincers pour les calculs du bassinnet
Pinze per calcoli renali



Fig. 1
PST-20-4801
23 cm / 9"



Fig. 2
PST-20-4802
21 cm / 8 2/8"



Fig. 3
PST-20-4803
19 cm / 7 4/8"



Fig. 4
PST-20-4804
18.5 cm / 7 2/8"

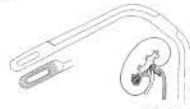

Fig. 5
PST-20-4805
19 cm / 7 4/8"

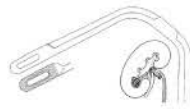

Fig. 6
PST-20-4806
19 cm / 7 4/8"



Randall
PST-20-4801 - PST-20-4806

Nierensteinzangen

Kidney Stone Forceps
Pinzas para cálculos renales
Pincers pour les calculs du bassinnet
Pinze per calcoli renali



Fig. 1
PST-20-4807
23 cm / 9"

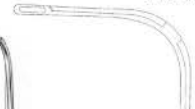

Fig. 2
PST-20-4808
24 cm / 9 4/8"



Randall
PST-20-4807 - PST-20-4808
besonders feines Modell
very slender pattern
modelo muy delgado
modèle très fin
modello molto delicato



Fig. 1
PST-20-4809
16 cm / 6 2/8"



Heiming
PST-20-4809 - PST-20-4810

für Kinder
for children
para niños
pour enfants
per bambini

Fig. 2
PST-20-4810
17 cm / 6 6/8"

Nierenfistelzangen

Nephrostomy Forceps
Pinzas para nefrostomia
Pincers à néphrostomie
Pinze per nefrostomia



Elsässer
PST-20-4811 - PST-20-4812
21 cm / 8 2/8"



Fig. 1
PST-20-4811

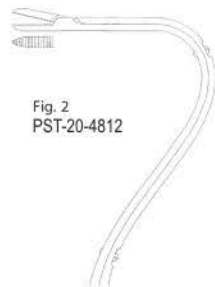

Fig. 2
PST-20-4812

Gallenkanaldilatatoren

Gall Duct Dilators
Dilatadores para conducto biliar
Dilatateurs pour les voies biliaires
Dilatatori per condotti biliari



Fig. 1
PST-20-4813
Ø 1.0 mm



Fig. 2
PST-20-4814
Ø 2.0 mm



Fig. 3
PST-20-4815
Ø 3.0 mm



Fig. 4
PST-20-4816
Ø 4.0 mm



Fig. 5
PST-20-4817
Ø 5.0 mm



Fig. 6
PST-20-4818
Ø 6.0 mm



Fig. 7
PST-20-4819
Ø 7.0 mm



Fig. 8
PST-20-4820
Ø 8.0 mm



Fig. 9
PST-20-4821
Ø 9.0 mm



Fig. 10
PST-20-4822
Ø 10 mm



Fig. 11
PST-20-4823
Ø 11 mm



Fig. 12
PST-20-4824
Ø 12 mm



Fig. 13
PST-20-4825
Ø 13 mm

Bakes
PST-20-4813 - PST-20-4825
32 cm / 12 5/8"
biegsamer Schaft
malleable shaft
vástago maleable
tige malléable
gambo malleabile



Gallensteinzangen

Gall Stone Forceps
Pinzas para cálculos biliares
Pinces pour calculs biliaires
Pinze per calcoli biliari



PST-20-4826



PST-20-4827

Blake
PST-20-4826 - PST-21-4427
21 cm / 8 2/8"



Mayo-Blake
PST-20-4828
21 cm / 8 2/8"



Mayo-Blake
PST-20-4829
21 cm / 8 2/8"



Gallensteinzangen

Gall Stone Forceps
Pinzas para cálculos biliares
Pinces pour calculs biliaires
Pinze per calcoli biliari



Mixer
PST-20-4830
22 cm / 8 5/8"



Desjardins
PST-20-4831 - PST-20-4832
23 cm / 9"



Fig. 1
PST-20-4831



Fig. 2
PST-20-4832



Gallensteinlöffel

Gall Stone Scoops
Cucharas para cálculos biliares
Curettes pour calculs biliaires
Pinze per calcoli biliari



Fig. 000
PST-20-4833
2.7 mm



Fig. 2
PST-20-4837
6.6 mm



Fig. 00
PST-20-4834
3.4 mm



Fig. 3
PST-20-4838
8 mm



Fig. 0
PST-20-4835
4.3 mm



Fig. 4
PST-20-4839
11 mm



Fig. 1
PST-20-4836
5.5 mm



Fig. 5
PST-20-4840
15 mm

Luer-Körte

PST-20-4833 - PST-20-4840
32 cm / 12 5/8"
biegsamer Schaft
malleable shaft
västago maleable
tige malléable
gambo malleabile



Prostatahaken

Prostatic Retractors
Separadores para próstata
Ecarteurs prostatiques
Divaricatori prostatici



Young
PST-20-4841
22 cm / 8 5/8"



Young
PST-20-4842
21.5 cm / 8 4/8"



Young
PST-20-4843
23 cm / 9"



Urologie

Urology
Urologia
Urologie
Urologia

20



Quality Instruments

Kapselasszangen

Capsule Forceps
Pinzas capsulares
Pincers pour saisir les capsules
Pinze per afferrare capsule

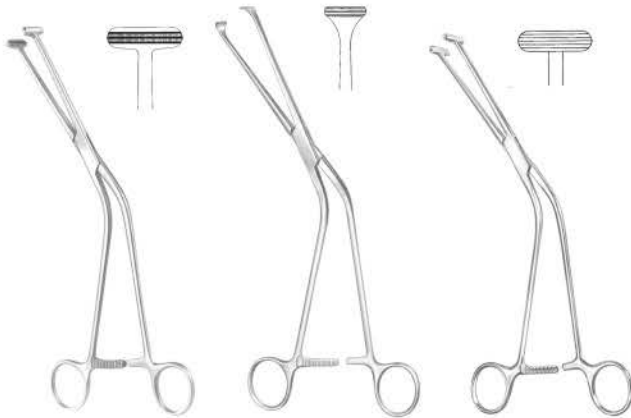

Millin

PST-20-4844
24.5 cm / 9 5/8"

Millin

PST-20-4845
22.5 cm / 8 7/8"

Millin

PST-20-4846
24.5 cm / 9 5/8"

Kapselasszange, Fadenführungsanzuge

Capsule Forceps, Ligature Carrying Forceps
Pinzas capsulares, Pinza porta ligaduras
Pincers pour saisir les capsules, Pince porte-fil
Pinze per afferrare capsule, Pinza porta-filo

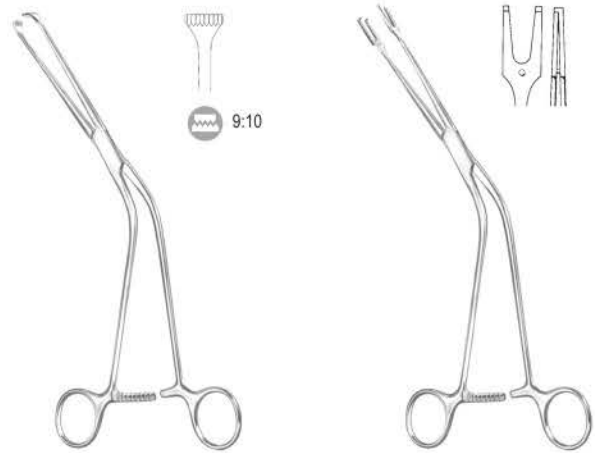

Millin

PST-20-4847
22 cm / 8 5/8"

Millin

PST-20-4848
24 cm / 9 4/8"

Blasenhalsperrer, Blasenwundsperrer

Bladder Neck Spreader, Bladder Retractors
Dilatador para el cuello vesical, Separadores vesicales
Ecarteur pour le col de la vessie, Ecarteurs vésicaux
Divaricatore del collo vescicale, Divaricatore vescicale



Millin

PST-20-4849
29.5 cm / 11 5/8"

Spreizweite
spreading
extensión
écartement
apertura
70 mm

Judd-Masson

PST-20-4850

Spreizweite
spreading
extensión
écartement
apertura
120 mm

Blasenwundsperrer

Bladder Retractors
Separadores vesicales
Ecarteurs vésicaux
Divaricatore vescicale



Millin

PST-20-4851

komplett, mit je 2 Seitenvalven
57 x 25 mm und 80 x 25 mm, sowie
einer 1 Mittelvalve 120 x 45 mm,
ohne Kaltlichtaufsatz

complete, with 2 pairs of lateral
blades 57 x 25 mm and 80 x 25 mm,
and 1 central blade 120 x 45 mm,
without F.O. carrier

completo, con 2 pares de valvas laterales
57 x 25 mm y 80 x 25 mm y
una valva central 120 x 45 mm,
sin portador de luz fría

complet, avec 2 paires de valvas
latérales 57 x 25 mm et 80 x 25 mm
et 1 valve centrale 120 x 45 mm,
sans support lumière froide

completo, con 2 paia di valve laterali
57 x 25 mm e 80 x 25 mm in più 1
valva centrale 120 x 45 mm,
senza supporto per luce fredda

PST-20-4852

Seitenvalven
Lateral Blades
alvas laterales
alves laterales
alve laterali
80 x 25 mm

PST-20-4854

Mittelvalven
entral Blades
alvas centrales
alves centrales
alve centrali
120 x 45 mm

Millin

PST-20-4852

komplett, mit je 2 Seitenvalven
57 x 25 mm und 80 x 25 mm, sowie
einer 1 Mittelvalve 120 x 45 mm,
mit Kaltlichtaufsatz

complete, with 2 pairs of lateral
blades 57 x 25 mm and 80 x 25 mm,
and 1 central blade 120 x 45 mm,
with F.O. carrier

completo, con 2 pares de valvas laterales
57 x 25 mm y 80 x 25 mm y
una valva central 120 x 45 mm,
on portador de luz fría

complet, avec 2 paires de valvas
latérales 57 x 25 mm et 80 x 25 mm
et 1 valve centrale 120 x 45 mm,
a e support lumière froide

completo, con 2 paia di valve laterali
57 x 25 mm e 80 x 25 mm in più
1 valva centrale 120 x 45 mm,
on supporto per luce fredda

PST-20-4853

Seitenvalven
Lateral Blades
alvas laterales
alves laterales
alve laterali
57 x 25 mm

PST-20-4855

Kaltlichtaufsatz
Fiber Optic Light arrier
ortador de luz fría
Support lumière froide
Supporto per luce fredda



Harnröhrenbougies

Urethral Sounds
Bujías uretrales
Bougies urétrales
Candeletta dilatatrici

Charrière	Van Buren	Guyon
6		
7		
8	PST-20-4856	
9		
10	PST-20-4857	PST-20-4871
11		PST-20-4872
12	PST-20-4858	PST-20-4873 PST-20-4891
13		PST-20-4874
14	PST-20-4859	PST-20-4875 PST-20-4892
15		PST-20-4876
16	PST-20-4860	PST-20-4877
17		PST-20-4878
18	PST-20-4861	PST-20-4879
19		PST-20-4880
20	PST-20-4862	PST-20-4881
21		PST-20-4882
22	PST-20-4863	PST-20-4883
23		PST-20-4884
24	PST-20-4864	PST-20-4885
25		PST-20-4886
26	PST-20-4865	PST-20-4887
27		PST-20-4888
28	PST-20-4866	PST-20-4889
29		PST-20-4890
30	PST-20-4867	
31		
32	PST-20-4868	
33		
34	PST-20-4869	
35		
36	PST-20-4870	



Van Buren PST-20-4856
27 cm / 10 5/8"

Guyon PST-20-4871
PST-20-4890
26.5 cm / 10 3/8"

PST-20-4891
PST-20-4892
15 cm / 5 7/8"

Metallkatheter für Frauen
Metal Catheters, female
Sondas metálicas, femeninas
Sondes métalliques, pour femmes
Sonde metalliche, per donne

PST-20-4856
Satz komplett, 8 - 36 Charrière
complete set, 8 - 36 Charrière
juego completo, 8 - 36 Charrière
jeu complet, 8 - 36 Charrière
set completo, 8 - 36 Charrière

Gleitsonde, Harnröhrenbougies

Filiform Bougie, Urethral Sounds
Sonda filiforme, Bujías uretrales
Bougie conductrice, Bougies urétrales
Candeletta filiforme, Candeletta dilatatrici

Charrière	
3	PST-20-4893
4	PST-20-4894
5	PST-20-4895
6	PST-20-4896



Filiform
PST-20-4893 - PST-20-4896

mit Schraubgewinde-Ansatz
with screw thread
con rosa de tornillo
avec embout fileté
con attacco filettato



Guyon
PST-20-4897

Satz mit 21 Bougies, 10 bis 30 CH,
mit 4 Gleitsonden, im Metalletui
42 x 17,5 x 4 cm

set with 21 bougies, 10 to 30 CH,
with 4 filiform bougies, in metal case
42 x 17,5 x 4 cm

juego de 21 bujías, 10 a 30 CH,
con 4 bujías filiformes, en caja
metálica 42 x 17,5 x 4 cm

jeu avec 21 bougies, 10 jusqu'à 30 CH,
avec 4 bougies conductrices, en boîte
métal 42 x 17,5 x 4 cm

set di 21 dilatatori, 10 fino a 30 CH,
con 4 candelette dilatatrici, in contenitore
metallico 42 x 17,5 x 4 cm



Urethrographie- u. Circumcisions-Instrumente

Urethrography- and Circumcision Instruments
Instrumentos para uretrografía y circuncisión
Instruments pour urétrographie et circoncision
Strumenti per uretrografia e circoncisione



Knutson
PST-20-4898

Urethrographieinstrument
Urethrography Instrument
Instrumento para uretrografía
Instrument pour urétrographie
Strumento per uretrografia

8 mm	PST-20-4901
11 mm	PST-20-4902
13 mm	PST-20-4903
16 mm	PST-20-4904
21 mm	PST-20-4905
26 mm	PST-20-4906
32 mm	PST-20-4907

Knutson-Koch
PST-20-4899
Konus, allein
Cone, only
Cono, suelto
Cône, seul
Cono, solo



PST-20-4901 - PST-20-4907

Circumcisionsgerät
Circumcision Instrument
Instrumento para circuncisión
Instrument de circoncision
Strumento per circoncisione



Mogen
PST-20-4900
7.5 cm / 3"

Beschneidungsinstrument
Circumcision Instrument
Instrumento para circuncisión
Instrument de circoncision
Strumento per circoncisione

Fremdkörperzangen

Foreign Body Forceps
Pinzas para cuerpos extraños
Pincers pour corps étrangers
Pinze per corpi estranei



Sachse
PST-20-4908
Meatotom
Meatotome
Meatótomo
Méatotome
Meatotomo

Mathieu
PST-20-4909
Schaftlänge
shaft length
longitud del vástago
longueur de la tige
lunghezza dell'asta
200 mm

Mathieu
PST-20-4910
Schaftlänge
shaft length
longitud del vástago
longueur de la tige
lunghezza dell'asta
280 mm

Sachse
PST-20-4911

Messlehre
Gauge
Calibre
Calibre
Calibro

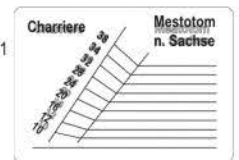

Penisklemmen

Penis Clamps
Clamps para pene
Pincers pour pénis
Serrapene



Stockmann
PST-20-4912
8 cm 3 1/8"



Strauss
PST-20-4913
11 cm / 4 3/8"



Gynäkologie
Gynecology
Ginecología
Gynécologia
Ginecologia



21

159 - 166

Geburtshilfe
Obstetrics
Obstetricia
Obstétrique
Ostetricia



22

167

Messzirket
Campares
Compases
Compass
Compassi



23

168



Vaginalspekula

Vaginal Specula
Espéculos vaginales
Spéculum vaginaux
Specoli vaginali



Cusco

PST-21-5001 75 x 32 mm
PST-21-5002 85 x 37 mm
PST-21-5003 100 x 35 mm

Cusco

PST-21-5004
75 x 18 mm

Cusco

PST-21-5005 90 x 22 mm
PST-21-5006 100 x 25 mm
PST-21-5007 105 x 27 mm

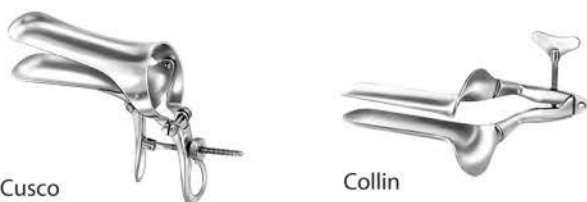

Cusco

PST-21-5008 75 x 34 mm
PST-21-5009 85 x 37 mm
PST-21-5010 100 x 37 mm

Collin

PST-21-5011 85 x 30 mm
PST-21-5012 100 x 35 mm
PST-21-5013 110 x 40 mm

Vaginalspekula

Vaginal Specula
Espéculos vaginales
Spéculum vaginaux
Specoli vaginali



Trelat

PST-21-5014 85 x 33 mm
PST-21-5015 95 x 35 mm
PST-21-5016 115 x 43 mm

Pederson

PST-21-5017 75 x 13 mm
PST-21-5018 100 x 24 mm
PST-21-5019 120 x 26 mm

Grave

PST-21-5020 75 x 20 mm
PST-21-5021 95 x 35 mm
PST-21-5022 115 x 35 mm



Semm

PST-21-5023 100 x 20-25 mm
PST-21-5024 100 x 27-35 mm



Guttman

PST-21-5025 90 x 35 mm

Vaginalspekula, Scheidenhalter

Vaginal Specula, Vaginal Retractors
Espéculos vaginales, Valvas vaginales
Spéculum vaginaux, Valves vaginales
Specoli vaginali, Valve vaginali



Kristeller

PST-21-5032 Fig. 1 70 x 27 mm
PST-21-5033 Fig. 2 80 x 30 mm
PST-21-5034 Fig. 3 90 x 36 mm



Jackson

PST-21-5029 75 x 38 mm
PST-21-5030 90 x 38 mm
PST-21-5031 100 x 38 mm

Sims

PST-21-5026 65 x 25 mm
PST-21-5027 70 x 30 mm
PST-21-5028 85 x 35 mm

Vaginalspekula, Scheidenhalter

Vaginal Specula, Vaginal Retractors
Espéculos vaginales, Valvas vaginales
Spéculum vaginaux, Valves vaginales
Specoli vaginali, Valve vaginali



Kristeller

PST-21-5041 Fig. 1 105 x 18 mm
PST-21-5042 Fig. 2 110 x 21 mm

Kristeller

PST-21-5038 Fig. 1
PST-21-5032 & PST-21-5035

PST-21-5039 Fig. 2
PST-21-5033 & PST-21-5036

PST-21-5040 Fig. 3
PST-21-5034 & PST-21-5037

Kristeller

PST-21-5035 Fig. 1 75 x 23 mm
PST-21-5036 Fig. 2 85 x 26 mm
PST-21-5037 Fig. 3 100 x 32 mm



Vaginalspekula, Scheidenhalter

Vaginal Specula, Vaginal Retractors
Espéculos vaginales, Valvas vaginales
Spéculum vaginaux, Valves vaginales
Specoli vaginali, Valve vaginali

flaches Spekulum
flat speculum
espécule plano
speculum plat
specolo piatto



Kristeller

PST-21-5043 Fig. 1 110 x 14 mm
PST-21-5044 Fig. 2 115 x 17 mm



Kristeller

PST-21-5047 Fig. 1 105 x 26 mm
PST-21-5048 Fig. 2 105 x 28 mm
PST-21-5049 Fig. 3 105 x 33 mm



Kristeller

PST-21-5045 Fig. 1
PST-21-5041 & PST-21-5043
PST-21-5046 Fig. 2
PST-21-5042 & PST-21-5044



Vaginalspekula, Scheidenhalter

Vaginal Specula, Vaginal Retractors
Espéculos vaginales, Valvas vaginales
Spéculum vaginaux, Valves vaginales
Specoli vaginali, Valve vaginali



Kristeller

PST-21-5050 Fig. 1 115 x 22 mm
PST-21-5051 Fig. 2 115 x 24 mm
PST-21-5052 Fig. 3 115 x 29 mm



Kristeller

PST-21-5056 Fig. 1 110 x 28 mm
PST-21-5057 Fig. 2 110 x 30 mm
PST-21-5058 Fig. 3 110 x 36 mm



Kristeller

PST-21-5053 Fig. 1
PST-21-5047 & PST-21-5050
PST-21-5054 Fig. 2
PST-21-5048 & PST-21-5051
PST-21-5055 Fig. 3
PST-21-5049 & PST-21-5052



Vaginalspekula, Scheidenhalter

Vaginal Specula, Vaginal Retractors
Espéculos vaginales, Valvas vaginales
Spéculum vaginaux, Valves vaginales
Specoli vaginali, Valve vaginali



Kristeller

PST-21-5059 Fig. 1 115 x 23 mm
PST-21-5060 Fig. 2 115 x 27 mm
PST-21-5061 Fig. 3 115 x 32 mm



Kristeller

PST-21-5062 Fig. 1
PST-21-5056 & PST-21-5059
PST-21-5063 Fig. 2
PST-21-5057 & PST-21-5060
PST-21-5064 Fig. 3
PST-21-5058 & PST-21-5061



Kallmorgen

PST-21-5065 Fig. 1 70 x 40 mm
PST-21-5066 Fig. 2 90 x 40 mm



Vaginalspekula, Scheidenhalter

Vaginal Specula, Vaginal Retractors
Espéculos vaginales, Valvas vaginales
Spéculum vaginaux, Valves vaginales
Specoli vaginali, Valve vaginali



Kallmorgen

PST-21-5067 Fig. 1
PST-21-5065 & PST-21-5079
PST-21-5068 Fig. 2
PST-21-5066 & PST-21-5080



Doyen

PST-21-5069 Fig. 1 58 x 35 mm
PST-21-5070 Fig. 2 88 x 35 mm
PST-21-5071 Fig. 3 118 x 35 mm
PST-21-5072 Fig. 1 60 x 47 mm
PST-21-5073 Fig. 2 78 x 47 mm
PST-21-5074 Fig. 3 120 x 47 mm
PST-21-5075 Fig. 4 165 x 47 mm
PST-21-5076 Fig. 1 55 x 60 mm
PST-21-5077 Fig. 2 85 x 60 mm
PST-21-5078 Fig. 3 115 x 60 mm

Kallmorgen

PST-21-5079 Fig. 1 70 x 37 mm
PST-21-5080 Fig. 2 90 x 37 mm





Vaginalspekula
Vaginal Specula
Espéculos vaginales
Spéculum vaginaux
Specoli vaginali

PST-21-5083 80 x 30 mm PST-21-5084 85 x 35 mm PST-21-5085 90 x 40 mm

Scherbak
Blatt, allein
Specula Blade, only
Valva vaginal, suelta
Valve vaginale, seule
Valve vaginale, sola

Scherbak
Blatt, allein
Specula Blade, only
Valva vaginal, suelta
Valve vaginale, seule
Valve vaginale, sola

Scherbak
Blatt, allein
Specula Blade, only
Valva vaginal, suelta
Valve vaginale, seule
Valve vaginale, sola

Scherbak
PST-21-5081
10.5 cm / 4" / 400 g

Gewicht zum Vaginalspekulum
Weight for Vaginal Speculum
Peso para espéculo vaginal
Poids pour spéculum vaginal
Peso per specolo vaginale

Scherbak
PST-21-5082
13 cm / 5" / 800 g

Gewicht zum Vaginalspekulum
Weight for Vaginal Speculum
Peso para espéculo vaginal
Poids pour spéculum vaginal
Peso per specolo vaginale

Scherbak
PST-21-5083 - PST-21-5087
Satz komplett mit Griff, Gewicht (400 g) und 5 Blättern
complete set with handle, weight (400 g) and 5 blades
juego completo con mango, peso (400 g) y 5 valvas
jeu complet avec manche, poids (400 g) et 5 valves
Set completo con manico, peso (400 g) e 5 valve

Scherbak
PST-21-5086
58 x 40 - 60 mm

Scherbak
PST-21-5087
70 x 45 - 70 mm

Vaginalspekula
Vaginal Specula
Espéculos vaginales
Spéculum vaginaux
Specoli vaginali

75 X 43mm

Scherbak
PST-21-5088
20 cm / 7 7/8"

Griff zum Vaginalspekulum
Handle for Vaginal Speculum
Mango para espéculo vaginal
Manche pour spéculum vaginal
Manico per specolo vaginale

Auvard
PST-21-5089
23.5 cm / 9 2/8"

komplett, mit abnehmbarem Gewicht
complete, with detachable weight
completo, con peso desmontable
complet, avec poids démontable
completo, con peso smontabile

Endospekula, Uterusdilatoren
Endocervical Specula, Uterine Dilators
Espéculos endocervicales, Dilatadores uterinos
Endospéculum, Dilatateurs du col de l'utérus
Endospecoli, Dilatatori uterini

Kogan
PST-21-5090
24.5 cm / 9 5/8"

Kogan
PST-21-5091
24.5 cm / 9 5/8"

Goodell
PST-21-5092
34 cm / 13 3/8"

Uterusdilatoren
Uterine Dilators
Dilatadores uterinos
Dilatateurs du col de l'utérus
Dilatatori uterini

mm Ø	PST-21-5093	PST-21-5093
1.0	PST-21-5093	PST-21-5093
1.5		
2.0	PST-21-5094	PST-21-5094
2.5		
3.0	PST-21-5095	PST-21-5095
3.5		
4.0	PST-21-5096	PST-21-5096
4.5		
5.0	PST-21-5097	PST-21-5097
5.5		
6.0	PST-21-5098	PST-21-5098
6.5		
7.0	PST-21-5099	PST-21-5099
7.5		
8.0	PST-21-5100	PST-21-5100
8.5		
9.0	PST-21-5101	PST-21-5101
9.5		
10.0	PST-21-5102	PST-21-5102
10.5		
11.0	PST-21-5103	PST-21-5103
11.5		
12.0	PST-21-5104	PST-21-5104
12.5		
13.0	PST-21-5105	PST-21-5105
13.5		
14.0	PST-21-5106	PST-21-5106
14.5		
15.0	PST-21-5107	PST-21-5107
15.5		
16.0	PST-21-5108	PST-21-5108
16.5		
17.0	PST-21-5109	PST-21-5109
17.5		

PST-21-5118
Satz mit 14 Stück (ganze Größen) von 4,0 bis 17,0 mm ohne Etui
set of 14 pieces (full sizes) from 4,0 to 17,0 mm without case
juego de 14 piezas (tamaños enteros) de 4,0 a 17,0 mm sin caja
jeu de 14 pièces (taille entière) de 4,0 jusqu'à 17,0 mm sans boîte
serie di 14 pezzi (grandezza intera) da 4,0 fino a 17,0 mm senza scatola

PST-21-5119
Satz mit 26 Stück (ganze Größen) von 1,0 bis 26,0 mm ohne Etui
set of 26 pieces (full sizes) from 1,0 to 26,0 mm without case
juego de 26 piezas (tamaños enteros) de 1,0 a 26,0 mm sin caja
jeu de 26 pièces (taille entière) de 1,0 jusqu'à 26,0 mm sans boîte
serie di 26 pezzi (grandezza intera) da 1,0 fino a 26,0 mm senza scatola

Hegar
PST-21-5093 - PST-21-5118
18.5 cm / 7 2/8"



Uterusdilatoren

Uterine Dilators
Dilatadores uterinos
Dilatateurs du col de l'utérus
Dilatatori uterini

Hegar

PST-21-5120

Satz mit 8 Stück von 3,0 / 4,0 bis 17,0 / 18,0 mm in auskochbarer Stoffrolle

set of 8 pieces from 3,0 / 4,0 to 17,0 / 18,0 mm in boilable canvas roll

juego de 8 piezas de 3,0 / 4,0 a 17,0 / 18,0 mm en bolsa de tela esterilizable por ebullición

jeu de 8 pièces de 3,0 / 4,0 jusqu'à 17,0 / 18,0 mm en pochette en treillis stérilisable par ébullition

serie di 8 pezzi di 3,0 / 4,0 jusqu'à 17,0 / 18,0 mm in busta di tela sterilizzabile



Hegar

	mm Ø	mm Ø	
PST-21-5121	1,0 / 2,0	PST-21-5131	21,0 / 22,0
PST-21-5122	3,0 / 4,0	PST-21-5132	23,0 / 24,0
PST-21-5123	5,0 / 6,0	PST-21-5133	25,0 / 26,0
PST-21-5124	7,0 / 8,0		
PST-21-5125	9,0 / 10,0		
PST-21-5126	11,0 / 12,0		
PST-21-5127	13,0 / 14,0		
PST-21-5128	15,0 / 16,0		
PST-21-5129	17,0 / 18,0		
PST-21-5130	19,0 / 20,0		

Uterusdilatoren

Uterine Dilators
Dilatadores uterinos
Dilatateurs du col de l'utérus
Dilatatori uterini



Hank

PST-21-5134 - PST-21-5139
26,5 cm / 10 3/8"

amerikanische Skala
American scale
escala americana
échelle américaine
scala americana

	Fig.	mm Ø
PST-21-5134	9 / 10	4,5 / 5,0
PST-21-5135	11 / 12	5,5 / 6,0
PST-21-5136	13 / 14	6,5 / 7,0
PST-21-5137	15 / 16	7,5 / 8,0
PST-21-5138	17 / 18	8,5 / 9,0
PST-21-5139	19 / 20	9,5 / 10,0

Hank

PST-21-5140

Satz mit 6 Stück in auskochbarer Stoffrolle

set of 6 pieces in boilable canvas roll
juego de 6 piezas en bolsa de tela esterilizable por ebullición

jeu de 6 pièces en pochette en treillis stérilisable par ébullition

serie di 6 pezzi in busta di tela sterilizzabile



Uterussonden, Uterusdepressor

Uterine Sounds, Uterine Depressor
Histerómetros, Depresor uterino
Hystéromètres, Dépresseur utérin
Isterometri, Depressore uterino

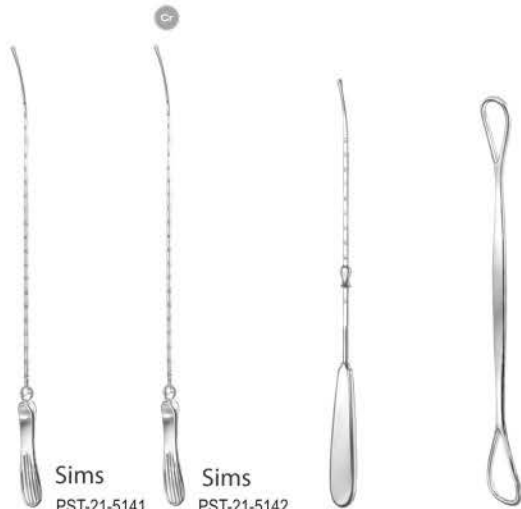

Sims

PST-21-5141
33 cm / 13"
starr
rigido
rigide
rigido

Sims

PST-21-5142
33 cm / 13"
biegsam
malleable
maleable
malleable
malleabile

Valleix

PST-21-5143
29,5 cm / 11 5/8"

Braun

PST-21-5144
27 cm / 10 5/8"



Hakenzangen, Amniotom

Uterine Tenaculum Forceps, Amniotome
Pinza para cuello uterino, Amniótomo
Pince pour le col de l'utérus, Amniotome
Pinza per il collo dell'utero, Amniotomo



Schröder

PST-21-5145
25,5 cm / 10"

Braun

PST-21-5146
26 cm / 10 2/8"

Duplay

PST-21-5147
28 cm / 11"

Beacham

PST-21-5148
26 cm / 10 2/8"



Gynäkologie

Gynecology
Ginecología
Gynécologia
Ginecologia

21



Quality Instruments

Hakenzangen

Uterine Tenaculum Forceps
Pinza para cuello uterino
Pince pour le col de l'utérus
Pinza per il collo dell'utero

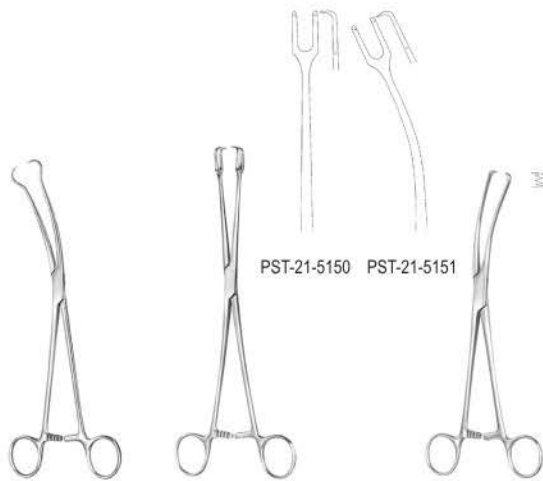

Skene

PST-21-5149
24 cm / 9 4/8"

Schröder

PST-21-5150 - PST-21-5151
25 cm / 9 7/8"

Teale

PST-21-5152
23 cm / 9"



2:2



3:4

Hakenzangen

Uterine Tenaculum Forceps
Pinza para cuello uterino
Pince pour le col de l'utérus
Pinza per il collo dell'utero



Iowa

PST-21-5153
26 cm / 10 2/8"



5:6

Museux

PST-21-5154 - PST-21-5156
24 cm / 9 4/8"



2:2

Jacobs

PST-21-5157
21 cm / 8 2/8"



2:2

PST-21-5154
7 mm

PST-21-5155
9 mm

PST-21-5156
10 mm

Hakenzangen

Uterine Tenaculum Forceps
Pinza para cuello uterino
Pince pour le col de l'utérus
Pinza per il collo dell'utero

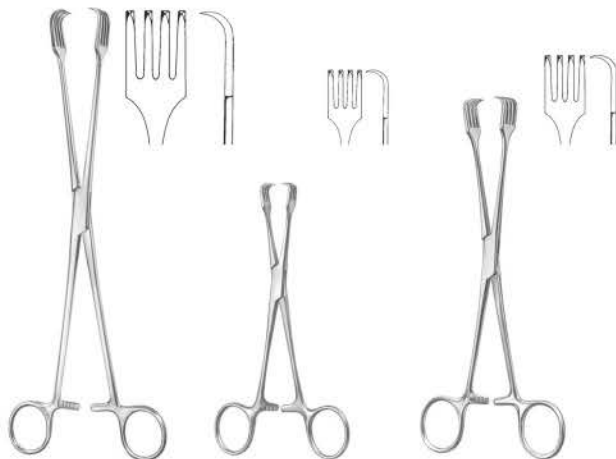

PST-21-5158
26.5 cm / 10 3/8"



4:4

Braun

PST-21-5159
16 cm / 6 2/8"



4:4

Czerny

PST-21-5160
21 cm / 8 2/8"



4:4

Uterus-Polypenzangen

Uterine Polypus Forceps
Pinzas para pólipos uterinos
Pincés à polypes utérins
Pinze per polipi uterini



Kelly

PST-21-5161
31.5 cm / 12 3/8"

Noto

PST-21-5162
27 cm / 10 5/8"

Heywood-Smith

PST-21-5163
26 cm / 10 2/8"



Myomheber, Myommesser

Myoma Screws, Myoma Knife
Tirabuzones para fibroma, Cuchillo para fibroma
Tracteurs pour fibromes, Evideur de fibromes
Tiramiomi, Bisturi per fibromi

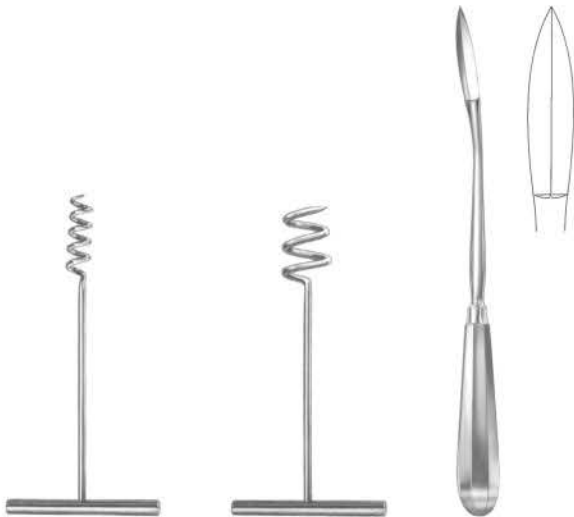

Doyen

PST-21-5164
17 cm / 6 5/8"
20 mm

Doyen

PST-21-5165
15 cm / 5 7/8"
29 mm

Segond

PST-21-5166
28 cm / 11"



Uterusfasszange

Uterine Seizing Forceps
Histerólabos
Pinces hystérolabes
Pinze isterolabi

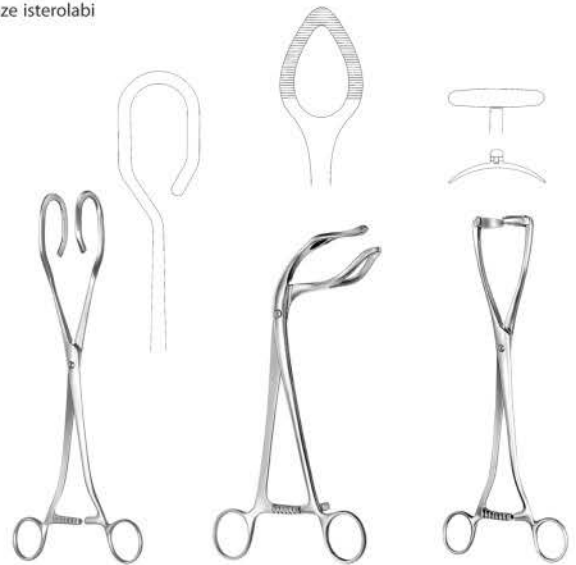

Dartigues

PST-21-5167
27 cm / 10 5/8"

Somer

PST-21-5168
22.5 cm / 8 7/8"

Collin

PST-21-5169
26.5 cm / 10 3/8"



Fistelhaken

Fistula Hooks
Ganchos para fistulas
Crochets pour fistules
Uncini per fistole

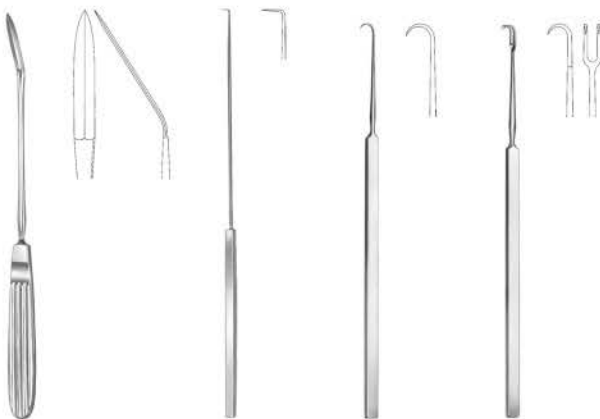

Ayre

PST-21-5170
23.5 cm / 9 2/8"

Konisationsmesser
Conization Knife
Bisturi para cono
Bistouri pour le cône d'attraction
Bisturi per il cono d'attrazione

Emmett

PST-21-5171
23 cm / 9"
Fig. 3

Simon

PST-21-5172
21.5 cm / 8 4/8"

Simon

PST-21-5173
21.5 cm / 8 4/8"



Saugküretten, Biopsieküretten

Suction Curettes
Curetas aspiradoras
Curettes à aspiration
Curette d'aspirazione

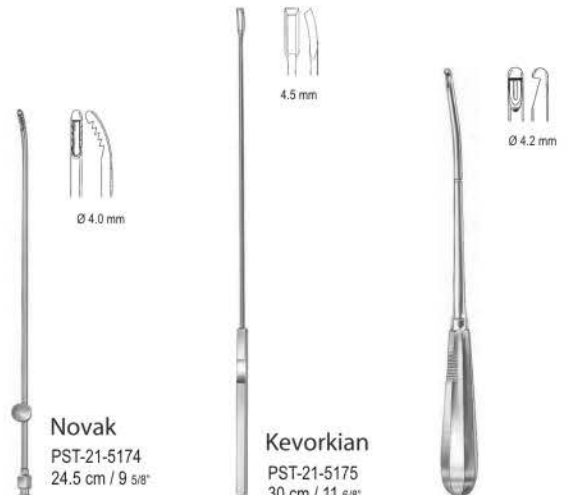

Novak

PST-21-5174
24.5 cm / 9 5/8"

mit Luer-Lock Ansatz
with Luer-Lock connection
con conexión Luer-Lock
avec connection Luer-Lock
con raccordo Luer-Lock

Kevorkian

PST-21-5175
30 cm / 11 5/8"

Mod. München

PST-21-5176
27 cm / 10 5/8"





Probeexzisionszangen

Uterine Biopsy Forceps
Pinzas para biopsia
Pincas pour biopsie
Pinze per biopsia

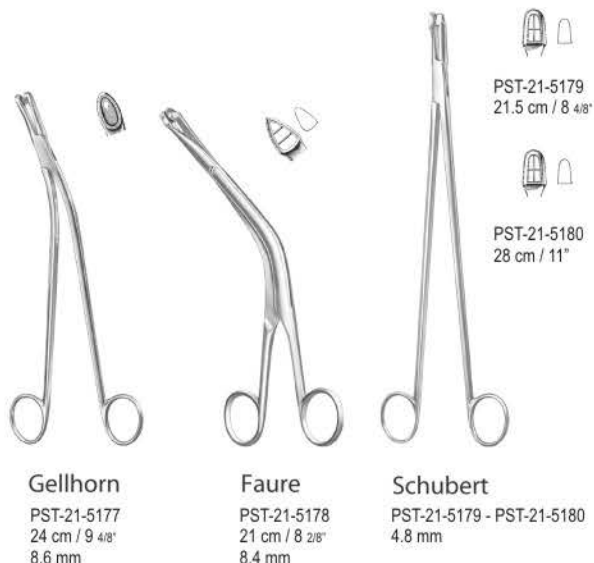

Probeexzisionszangen

Uterine Biopsy Forceps
Pinzas para biopsia
Pincas pour biopsie
Pinze per biopsia



Probeexzisionszangen

Uterine Biopsy Forceps
Pinzas para biopsia
Pincas pour biopsie
Pinze per biopsia

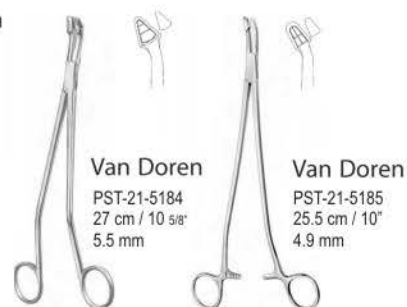

Probeexzisionszangen

Uterine Biopsy Forceps
Pinzas para biopsia
Pincas pour biopsie
Pinze per biopsia

Alexander

PST-21-5186

retrograder Schnitt, Maul nach links gebogen, geeignet für Kolposkopie
retrograde cutting, jaws curved to left, suitable als in colposcopy
corte retrograde, boca curva hacia izquierda, utilizable en colposcopia
coupe retrograde, mors courbé vers gauche, approprié pour colposcopie
filo retrogrado, morso curvato verso, adatto per colposcopia

Schaftlänge
shaft length
longitud del vástago
longueur de la tige
lunghezza dell'asta
195 mm

Maul 5,1 mm breit
jaw 5.1 mm wide
boca 5,1 mm de ancho
mors largeur 5,1 mm
morso larghezza 5,1 mm



Schaftlänge
shaft length
longitud del vástago
longueur de la tige
lunghezza dell'asta
230 mm

Maul 3 mm breit
jaw 3 mm wide
boca 3 mm de ancho
mors largeur 3 mm
morso larghezza 3 mm



Kevorkian
PST-21-5187

Schaftlänge
shaft length
longitud del vástago
longueur de la tige
lunghezza dell'asta
225 mm

Maul 5,4 mm breit
jaw 5.4 mm wide
boca 5,4 mm de ancho
mors largeur 5,4 mm
morso larghezza 5,4 mm



Schumacher
PST-21-5188

Probeexzisionszangen, IUP-Fasszangen

Uterine Biopsy Forceps, IUP Grasping Forceps
Pinzas para biopsia, Pinzas para coger DIU
Pincas pour biopsie, Pincas pour DIU
Pinze per biopsia, Pinze per DIU

Schumacher

PST-21-5189 - PST-21-5190
25 cm / 9 6/8"

PST-21-5191

Handgriff, allein
Handle, only
Mango, suelta
Manico, sola

PST-21-5192

Verlängerungsrohr, allein
Interchangeable tube, only
Tubo de extension, suelta
Tubo rallonge, seule
Tubo allunghi, sola



PST-21-5189
komplett
complete
completo
complet
completo

PST-21-5190
Aufsatz allein
Tip only
Punta suelta
Embout, seul
Punta, sola



PST-21-5193
27 cm / 10 5/8"
3.0 mm
Schaftlänge
shaft length
longitud del vástago
longueur de la tige
lunghezza dell'asta
225 mm

PST-21-5194
32 cm / 12 5/8"
3.0 mm
Schaftlänge
shaft length
longitud del vástago
longueur de la tige
lunghezza dell'asta
270 mm

PST-21-5193 - PST-21-5194

flexibler Schaft, zum Fassen von Intrauterinpressaren
flexible shaft, for grasping intra uterine pessary vástago flexible, para coger dispositivos intra-uterinos
tige flexible, pour saisir dispositif intra-utérin asta flessibile, per afferrare dispositivo intra-uterino





Uteruslöffel, Uterusküretten

Uterine Scoops, Uterine Curettes
Cucharillas uterinas, Curetas uterinas
Curettes utérines, Curettes utérines
Curette uterine, Curette uterine

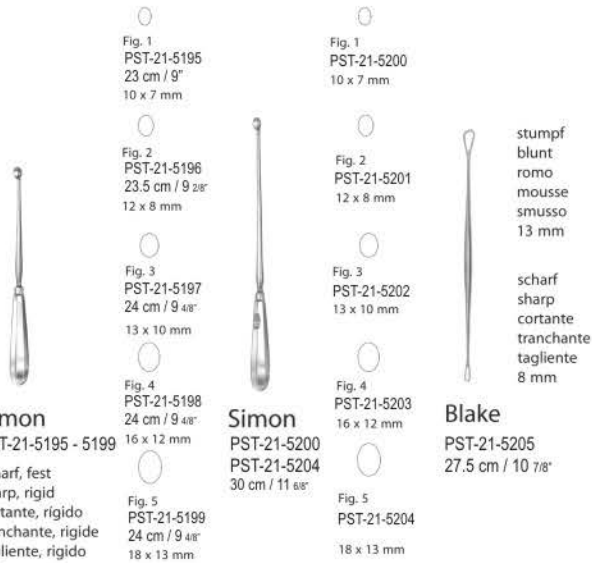

Simon
PST-21-5195 - 5199
scharf, fest
sharp, rigid
cortante, rígido
tranchante, rigide
tagliante, rigido

Simon
PST-21-5200
PST-21-5204
30 cm / 11 3/8"

Blake
PST-21-5205
27.5 cm / 10 7/8"

Uterusküretten

Uterine Curettes
Curetas uterinas
Curettes utérines
Curette uterine

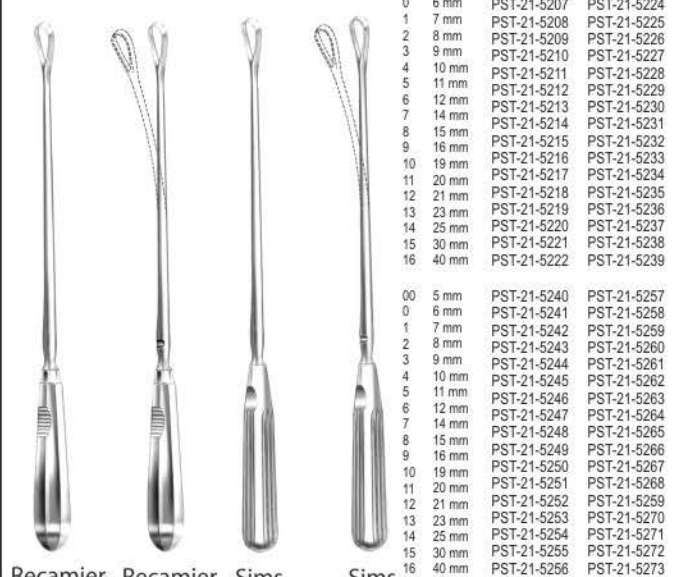

Recamier PST-21-5206 PST-21-5223
21-5222 21-5239
Sims PST-21-5240 PST-21-5257
21-5256 21-5273

Breite width anchura largeur larghezza	scharf, fest sharp, rigid cortante, rígido tranchante, rigide tagliante, rigido	scharf, biegsam sharp, malleable cortante, maleable tranchante, malléable tagliante, malleabile
----------------------------------------------------	---------------------------------------------------------------------------------------------	-------------------------------------------------------------------------------------------------------------

Fig. 00	5 mm	PST-21-5206	PST-21-5223
0	6 mm	PST-21-5207	PST-21-5224
1	7 mm	PST-21-5208	PST-21-5225
2	8 mm	PST-21-5209	PST-21-5226
3	9 mm	PST-21-5210	PST-21-5227
4	10 mm	PST-21-5211	PST-21-5228
5	11 mm	PST-21-5212	PST-21-5229
6	12 mm	PST-21-5213	PST-21-5230
7	14 mm	PST-21-5214	PST-21-5231
8	15 mm	PST-21-5215	PST-21-5232
9	16 mm	PST-21-5216	PST-21-5233
10	19 mm	PST-21-5217	PST-21-5234
11	20 mm	PST-21-5218	PST-21-5235
12	21 mm	PST-21-5219	PST-21-5236
13	23 mm	PST-21-5220	PST-21-5237
14	25 mm	PST-21-5221	PST-21-5238
15	30 mm	PST-21-5222	PST-21-5239
16	40 mm		
00	5 mm	PST-21-5240	PST-21-5257
0	6 mm	PST-21-5241	PST-21-5258
1	7 mm	PST-21-5242	PST-21-5259
2	8 mm	PST-21-5243	PST-21-5260
3	9 mm	PST-21-5244	PST-21-5261
4	10 mm	PST-21-5245	PST-21-5262
5	11 mm	PST-21-5246	PST-21-5263
6	12 mm	PST-21-5247	PST-21-5264
7	14 mm	PST-21-5248	PST-21-5265
8	15 mm	PST-21-5249	PST-21-5266
9	16 mm	PST-21-5250	PST-21-5267
10	19 mm	PST-21-5251	PST-21-5268
11	20 mm	PST-21-5252	PST-21-5269
12	21 mm	PST-21-5253	PST-21-5270
13	23 mm	PST-21-5254	PST-21-5271
14	25 mm	PST-21-5255	PST-21-5272
15	30 mm	PST-21-5256	PST-21-5273
16	40 mm		

Uterusküretten

Uterine Curettes
Curetas uterinas
Curettes utérines
Curette uterine

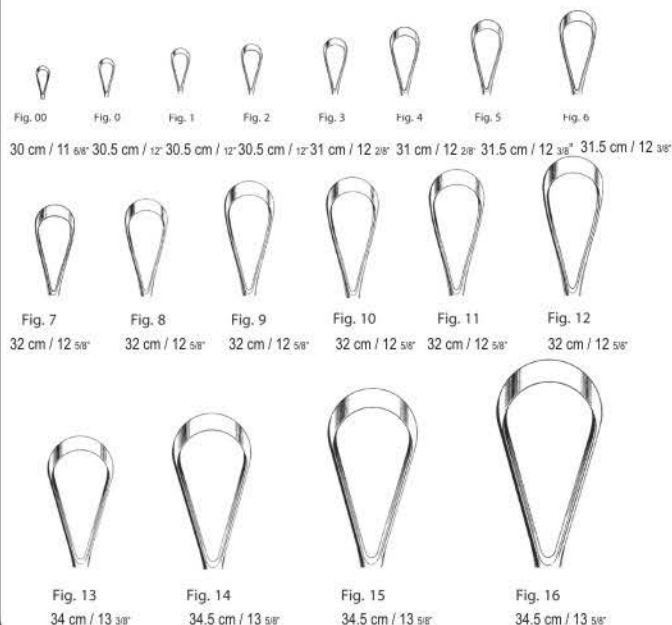

Fig. 00 30 cm / 11 3/8" Fig. 0 30.5 cm / 12" Fig. 1 30.5 cm / 12" Fig. 2 30.5 cm / 12" Fig. 3 31 cm / 12 2/8" Fig. 4 31 cm / 12 2/8" Fig. 5 31.5 cm / 12 3/8" Fig. 6 31.5 cm / 12 3/8"

Fig. 7 32 cm / 12 5/8" Fig. 8 32 cm / 12 5/8" Fig. 9 32 cm / 12 5/8" Fig. 10 32 cm / 12 5/8" Fig. 11 32 cm / 12 5/8" Fig. 12 32 cm / 12 5/8"

Fig. 13 34 cm / 13 3/8" Fig. 14 34.5 cm / 13 5/8" Fig. 15 34.5 cm / 13 5/8" Fig. 16 34.5 cm / 13 5/8"

Uterusküretten, Absaugküretten

Uterine Curettes, Suction Curettes
Curetas uterinas, Curetas aspiradoras
Curettes utérines, Curettes d'aspiration
Curette uterine, Curette per aspirazione

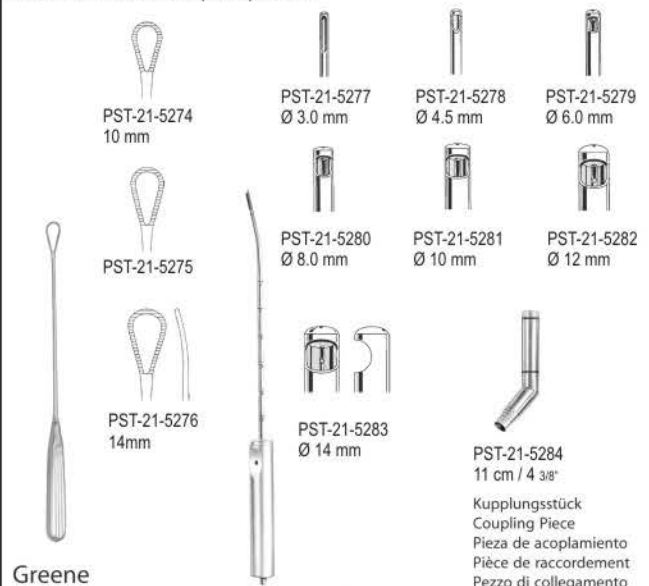

Greene
PST-21-5274 - PST-21-5276
28 cm / 11"
PST-21-5277 - PST-21-5283
29 cm / 11 3/8"

PST-21-5284
11 cm / 4 3/8"
Kupplungsstück
Coupling Piece
Pieza de acoplamiento
Pièce de raccordement
Pezzo di collegamento



Beckenzirkel, Geburtszangen

Pelvimeter Obstetrical Forceps
Pelvimetro Forceps obstétricos
Pelvimètre Forceps obstétriques
Pelvimetri Forcipi obstetrici



Skala in cm und Inch
cm / inch scale
escala en cm / pulgadas
échelle en cm / pouces
scal in cm / pollici



Kielland
PST-22-5302
41 cm / 16 1/8"



Kielland-Luikart
PST-22-5303
40 cm / 15 6/8"



Piper
PST-22-5304
44.5 cm / 17 4/8"



Nägele
PST-22-5305 - 5306
35 cm / 13 6/8"

PST-22-5305
36.5 cm / 14 3/8"



Simpson
PST-22-5307
30.5 cm / 12"



Wrigley
PST-22-5308
28 cm / 11"



Simpson
PST-22-5309
36.5 cm / 14 2/8"

Abortuszangen

Placenta and Ovum Forceps
Pinzas para aborto
Pincas placentaires et pour poste-abortum
Pinze per placenta e per ovaie



Green-Armytage
PST-22-5310
21 cm / 8 2/8"
Klemmzange
Uterine Clamp
Pinza uterina para hemostasis
Pince utérine pour hémostase
Pinza emostatiche per tagli cesarei



Sänger
PST-22-5311 - PST-22-5312



PST-22-5311
27.5 cm / 10 7/8"



PST-22-5312
27 cm / 10 5/8"



Winter
PST-22-5313 - PST-22-5316
28 cm / 11"

Fig. 1
PST-22-5313

Fig. 2
PST-22-5314

Fig. 1
PST-22-5315

Fig. 2
PST-22-5316



Sellheim
PST-22-5317
32 cm / 12 5/8"
Geburtslöffel
Obstetrical Lever
Elevador obstétrico
Levier obstétrique
Leva ostetrica

Abortuslöffel

Placenta Scoops
Cucharillas para aborto
Curettes a avortement et placenta
Cucchiai per placenta e ovaie



Cuzzi
PST-22-5318 - PST-22-5320
30 cm / 11 6/8"
stumpf, Rückseite gerieft
blunt, backside serrated
romo, dorso estriado
mousse, verso estrie
smusso, dorso scanallato



PST-22-5318
17 mm



PST-22-5319
20 mm



PST-22-5320
23 mm

Abortuslöffel, Nabelschnurklemmen

Placenta Scoops, Umbilical Cord Clamps
Cucharillas para aborto, Clamps umbilicales
Curettes a avortement et placenta, Clamps ombilicaux
Cucchiai per placenta e ovaie, Clamps ombelicali



Cuzzi
PST-22-5321
30.5 cm / 12"

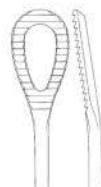

Kane
PST-22-5322
8.5 cm / 3 3/8"



Collin
PST-22-5323
8.5 cm / 3 3/8"

Messzirket

Campares
Compasses
Compase
Compassi

23



Quality Instruments

Meßzirkel, Kellenmesser

Calipers, Trowel Knifes
Compases, Cuchillos de paleta
Compas, Couteaux de truelle
Compassi, Coltelli di cazzuola



Castroviejo
PST-23-5403
8 cm / 3 1/8"
Messbereich
effective range
alcance eficaz
série effectif
rango effective
0-20 mm



Castroviejo
PST-23-5404
8 cm / 3 1/8"
Messbereich
effective range
alcance eficaz
série effectif
rango effective
0-20 mm



PST-23-5401
4 x 6 mm



PST-23-5402
7 x 11 mm



Castroviejo
PST-23-5405
8 cm / 3 1/8"
Messbereich
effective range
alcance eficaz
série effectif
rango effective
0-15 mm

PST-23-5401 - PST-23-5402
16.5 cm / 6 4/8"



Castroviejo-Epker
PST-23-5406
9 cm / 3 4/8"
Messbereich
effective range
alcance eficaz
série effectif
rango effective
0-40 mm



Castroviejo-Epker
PST-23-5407
18 cm / 7 1/8"
Messbereich
effective range
alcance eficaz
série effectif
rango effective
0-40 mm



Sonden

Probes
Sondas
Sondes
Sonde



Fig.
00 / 0 PST-23-5408
0 / 1 PST-23-5409
1 / 2 PST-23-5410
2 / 3 PST-23-5411
3 / 4 PST-23-5412
4 / 5 PST-23-5413
6 / 7 PST-23-5414
7 / 8 PST-23-5415



Fig.
00 / 0 PST-23-5416
0 / 1 PST-23-5417
1 / 2 PST-23-5418
2 / 3 PST-23-5419
3 / 4 PST-23-5420
4 / 5 PST-23-5421
6 / 7 PST-23-5422
7 / 8 PST-23-5423

Bowman
PST-23-5408 - PST-23-5415
13 cm / 5 1/8"

Bowman
PST-23-5416 - PST-23-5423
13 cm / 5 1/8"



Otologie
Otology
Otología
Otologie
Otologia



24

169 - 176

Rhinologie
Rhinologie
Rinología
Rhinologia
Rinologia



25

177 - 185

Mund-,Kiefer- Gesichtschirurgie
Oral Maxillo-Facial Surgery
Cirugía oral y maxilofacial
Chirurgie buccale et maxillo-faciale
Chirurgie buccale e maxillo-faciale



26

186 - 197



Mikro-Ohrzängchen

Micro Ear Forceps
Micro pinzas auriculares
Micro Pince auriculaires
Micro Pinze auricolari



PST-24-5501 - PST-24-5504

PST-24-5504
4.0 x 0.8 mm
rechts, gerieft
right, serrated
derecha, estriada
droite, striée
destra, con scanalatura

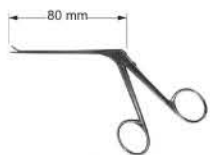

Mini-McGee
PST-24-5505 - PST-24-5506

PST-24-5501
4.0 x 0.8 mm
glatt, gerade
smooth, straight
lisa, recta
lisse, droite
liscia, retta

PST-24-5502
4.0 x 0.8 mm
gerieft, gerade
serrated, straight
estriada, recta
striée, droite
con scanalatura, retta

PST-24-5503
4.0 x 0.8 mm
aufgebogen, gerieft
bent upwards, serrated
curva por arriba, estriada
courbée vers le haut, striée
curva in alto, con scanalatura

PST-24-5505
3.5 x 0.6 mm
gerieft, gerade
serrated, straight
estriada, recta
striée, droite
con scanalatura, retta

PST-24-5506
3.5 x 0.6 mm
glatt, gerade
smooth, straight
lisa, recta
lisse, droite
liscia, retta

Mikro-Ohrzängchen

Micro Ear Forceps
Micro pinzas auriculares
Micro Pince auriculaires
Micro Pinze auricolari

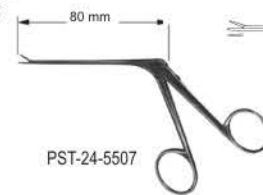

PST-24-5507

PST-24-5507
glatt, gerade
smooth, straight
lisa, recta
lisse, droite
liscia, retta

PST-24-5510
links, gerieft
left, serrated
izquierda, estriada
gauche, striée
sinistra, con scanalatura

PST-24-5508
4.0 x 0.6 mm
gerieft, gerade
serrated, straight
estriada, recta
striée, droite
con scanalatura, retta

PST-24-5511
rechts, gerieft
right, serrated
derecha, estriada
droite, striée
destra, con scanalatura

PST-24-5509
aufgebogen, gerieft
bent upwards, serrated
curva por arriba, estriada
courbée vers le haut, striée
curva in alto, con scanalatura



PST-24-5508 - PST-24-5511

Mikro-Ohrzängchen

Micro Ear Forceps
Micro pinzas auriculares
Micro Pince auriculaires
Micro Pinze auricolari



Löffel
cup
cucharilla
curette
cucchiaio
1,0 x 0,9 mm

PST-24-5512 - PST-24-5515

PST-24-5514
4.0 mm
links
left
izquierda
gauche
sinistra

PST-24-5512
4.0 mm
gerade
straight
recta
droite
retta

PST-24-5515
4.0 mm
rechts
right
derecha
droite
destra

PST-24-5513
4.0 mm
aufgebogen
bent upwards
curva por arriba
courbée en haut
curva in alto



Mini-McGee
PST-24-5516 - PST-24-5519

Löffel
cup
cucharilla
curette
cucchiaio
0,6 x 0,5 mm

PST-24-5516
3.5 mm
links
left
izquierda
gauche
sinistra

PST-24-5518
3.5 mm
gerade
straight
recta
droite
retta

PST-24-5517
3.5 mm
rechts
right
recta
droite
destra

PST-24-5519
3.5 mm
aufgebogen
bent upwards
curva por arriba
courbée en haut
curva in alto

Mikro-Ohrscherchen

Micro Ear Scissors
Micro tijeras auriculares
Micro Ciseaux auriculaires
Micro Forbici auricolari



Bellucci
PST-24-5520 - PST-24-5523

sehr fein
very fine
muy fina
très fine
molto delicata

PST-24-5522
links
left
izquierda
gauche
sinistra

PST-24-5520
gerade
straight
recta
droite
retta

PST-24-5523
rechts
right
derecha
droite
retta

PST-24-5521
aufgebogen
bent upwards
curva por arriba
courbée vers le haut
curva in alto

PST-24-5526
rechts
right
derecha
droite
destra

PST-24-5524
gerade
straight
recta
droite
retta



Wullstein
PST-24-5524 - PST-24-5527

PST-24-5527
links
left
izquierda
gauche
sinistra

PST-24-5525
aufgebogen
bent upwards
curva por arriba
courbée vers le haut
curva in alto



Mikro-Ohrzängchen

Micro Ear Forceps
Micro pinzas auriculares
Micro Pince auriculaires
Micro Pinze auricolari

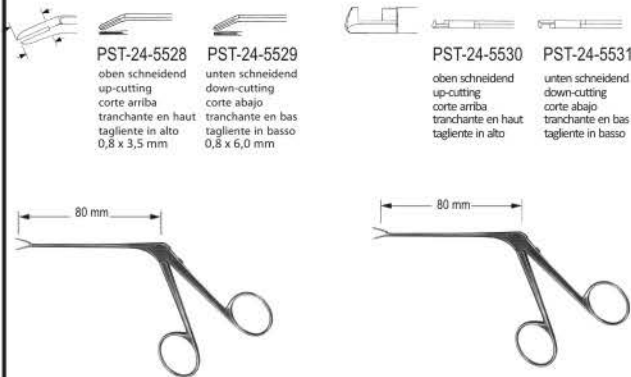

PST-24-5528
oben schneidend
up-cutting
corte arriba
tranchante en haut
tagliante in alto
0,8 x 3,5 mm

PST-24-5529
unten schneidend
down-cutting
corte abajo
tranchante en bas
tagliante in basso
0,8 x 6,0 mm

PST-24-5530
oben schneidend
up-cutting
corte arriba
tranchante en haut
tagliante in alto

PST-24-5531
unten schneidend
down-cutting
corte abajo
tranchante en bas
tagliante in basso

McGee
PST-24-5528 - PST-24-5529
0,8 x 3,5 mm

abgebogen
bent downwards
curva por abajo
courbée vers le bas
curva in basso

House-Dieter
PST-24-5530 - PST-24-5531

Hammerkopfzängchen
Malleus Nipper
Pinza para cabezal del maléolo
Pince pour l'os marteau
Pinza per testa del martelletto

Mikro-Ohrmesser

Micro Ear Knives
Micro cuchillos auriculares
Micro Couteaux auriculaires
Micro Coltelli

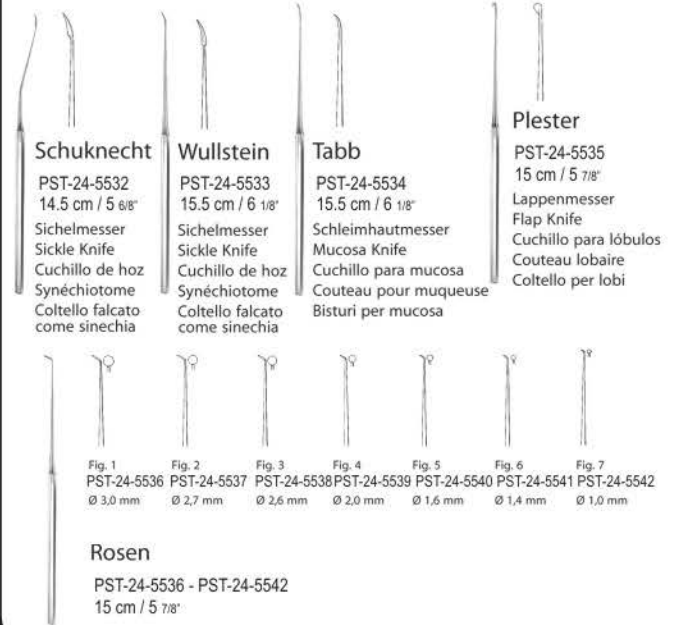

Schuknecht
PST-24-5532
14.5 cm / 5 7/8"
Sichelmesser
Sickle Knife
Cuchillo de hoz
Synéchiotome
Cottello falcato
come sinechia

Wullstein
PST-24-5533
15.5 cm / 6 1/8"
Sichelmesser
Sickle Knife
Cuchillo de hoz
Synéchiotome
Cottello falcato
come sinechia

Tabb
PST-24-5534
15.5 cm / 6 1/8"
Schleimhautmesser
Mucosa Knife
Cuchillo para mucosa
Couteau pour muqueuse
Bisturi per mucosa

Plester
PST-24-5535
15 cm / 5 7/8"
Lappenmesser
Flap Knife
Cuchillo para lóbulos
Couteau lobaire
Cottello per lobi

Fig. 1 PST-24-5536 Ø 3.0 mm
Fig. 2 PST-24-5537 Ø 2.7 mm
Fig. 3 PST-24-5538 Ø 2.6 mm
Fig. 4 PST-24-5539 Ø 2.0 mm
Fig. 5 PST-24-5540 Ø 1.6 mm
Fig. 6 PST-24-5541 Ø 1.4 mm
Fig. 7 PST-24-5542 Ø 1.0 mm

Rosen
PST-24-5536 - PST-24-5542
15 cm / 5 7/8"



Mikro-Ohrhäkchen, Mikro-Ohrnadeln

Micro Ear Hooks, Micro Ear Needles
Micro ganchitos auriculares, Micro agujas auriculares
Micro Crochets auriculaires, Micro Aiguilles auriculaires
Micro Uncini auricolari, Micro Aghi auricolari

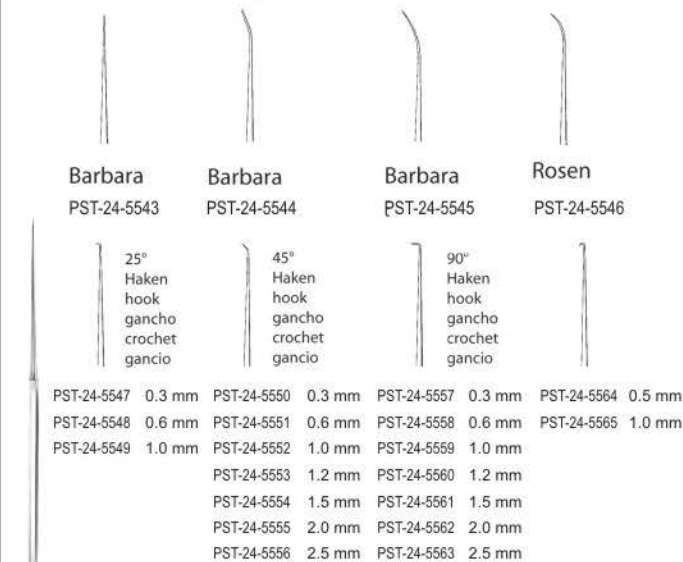

Barbara
PST-24-5543

Barbara
PST-24-5544

Barbara
PST-24-5545

Rosen
PST-24-5546

25°
Haken
hook
gancho
crochet
gancio

45°
Haken
hook
gancho
crochet
gancio

90°
Haken
hook
gancho
crochet
gancio

PST-24-5547 0.3 mm	PST-24-5550 0.3 mm	PST-24-5557 0.3 mm	PST-24-5564 0.5 mm
PST-24-5548 0.6 mm	PST-24-5551 0.6 mm	PST-24-5558 0.6 mm	PST-24-5565 1.0 mm
PST-24-5549 1.0 mm	PST-24-5552 1.0 mm	PST-24-5559 1.0 mm	
	PST-24-5553 1.2 mm	PST-24-5560 1.2 mm	
	PST-24-5554 1.5 mm	PST-24-5561 1.5 mm	
	PST-24-5555 2.0 mm	PST-24-5562 2.0 mm	
	PST-24-5556 2.5 mm	PST-24-5563 2.5 mm	

Barbara
PST-24-5547 - PST-25-5565
16 cm / 6 2/8"

Mikro-Ohrhäkchen, Mikro-Ohrnadeln

Micro Ear Hooks, Micro Ear Needles
Micro ganchitos auriculares, Micro agujas auriculares
Micro Crochets auriculaires, Micro Aiguilles auriculaires
Micro Uncini auricolari, Micro Aghi auricolari

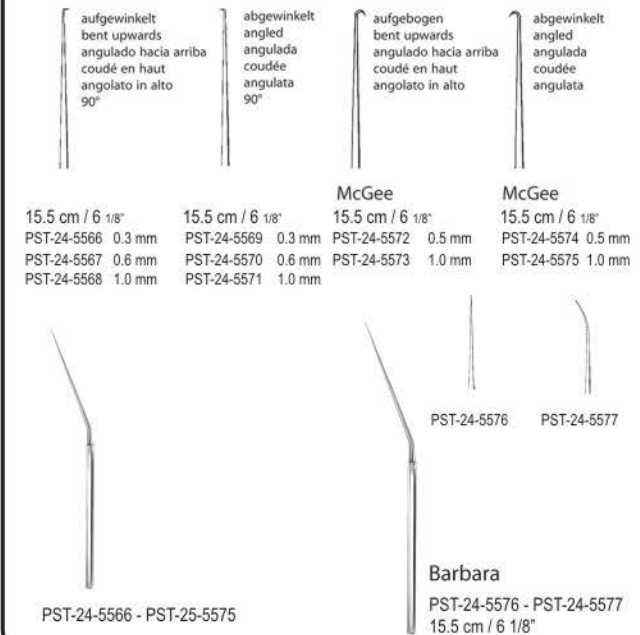

aufgewinkelt
bent upwards
angulado hacia arriba
coudé en haut
angolato in alto
90°

abgewinkelt
angled
angulada
coudée
angulata
90°

aufgebogen
bent upwards
angulado hacia arriba
coudé en haut
angolato in alto

abgewinkelt
angled
angulada
coudée
angulata

15.5 cm / 6 1/8"
PST-24-5566 0.3 mm
PST-24-5567 0.6 mm
PST-24-5568 1.0 mm

15.5 cm / 6 1/8"
PST-24-5569 0.3 mm
PST-24-5570 0.6 mm
PST-24-5571 1.0 mm

McGee
15.5 cm / 6 1/8"
PST-24-5572 0.5 mm
PST-24-5573 1.0 mm

McGee
15.5 cm / 6 1/8"
PST-24-5574 0.5 mm
PST-24-5575 1.0 mm

PST-24-5566 - PST-25-5575

Barbara
PST-24-5576 - PST-24-5577
15.5 cm / 6 1/8"





Mikro-Ohrhäkchen, Mikro-Dissektoren

Micro Ear Hooks, Micro Dissectors
Micro ganchitos auriculares, Micro dissecadores
Micro Crochets auriculaires, Micro Dissecteurs
Micro Uncini auricolari, Micro Dissettori

PST-24-5578	PST-24-5579	Shambaugh PST-24-5580	PST-24-5581	PST-24-5582	Shambaugh PST-24-5583
Shea 45° Sondierhaken Exploring Hook Ganchito explorador Crochet à exploration uncino di sondaggio 2.0 mm PST-24-5578 - 5583 15 cm / 5 7/8"			Austin 90° Attikusdissektor Attic Dissector Dissecador para el ático Dissecteur pour l'attique Dissettore per l'attico 3.0 mm PST-24-5585		
PST-24-5586 15 cm / 5 7/8" nach rechts abgewinkelt angled to right angulada por derecha coudée vers droite angulata a destra	PST-24-5587 15 cm / 5 7/8" nach links abgewinkelt angled to left angulada por izquierda coudée vers gauche angulata a sinistra	PST-24-5588 15.5 cm / 6 1/8"	PST-24-5589 15.5 cm / 6 1/8"	Rosen PST-24-5590 15 cm / 5 7/8" 1.2 mm Mikro-Ohrspatorium Micro Ear Periosteal Elevator Micro Legra auricular Micro Ruggine-Raspatoire auriculaire Micro Raspatore auricolare	
Fisch PST-24-5586 - PST-24-5589					

Mikro-Küretten, Mikro-Messsonden

Micro Curettes, Micro Measuring Rods
Micro cucharillas, Micro Sondas para medir
Micro Curettes, Micro Sondes pour mesurer
Micro cucchiari, Micro Sonde per misurare

PST-24-5591 3.5 mm	PST-24-5592 4.0 mm	PST-24-5593 4.5 mm	PST-24-5594 5.0 mm
House PST-24-5591 - PST-24-5594 15.5 cm / 6 1/8"			
PST-24-5595 Ø 1.0 mm	PST-24-5596 Ø 1.5 mm	PST-24-5597 Ø 1.0 mm	
PST-24-5595 Ø 1.2 mm	PST-24-5596 Ø 1.8 mm	PST-24-5597 Ø 1.2 mm	
House PST-24-5595 - PST-24-5597 14.5 cm / 5 8/8"			

Ohrspekula

Ear Specula
Espéculos auriculares
Spéculums auriculaires
Specoli auricolari

Fig. 0 PST-24-5598 3.6 cm / 1 3/8" Ø 3.0 mm	Fig. 1 PST-24-5599 3.6 cm / 1 3/8" Ø 4.0 mm	Fig. 2 PST-24-5600 3.6 cm / 1 3/8" Ø 5.0 mm	Fig. 3 PST-24-5601 3.6 cm / 1 3/8" Ø 6.0 mm	Fig. 4 PST-24-5602 3.6 cm / 1 3/8" Ø 7.5 mm
Fig. 0 - 2 PST-24-5603 Hartmann PST-24-5598 -5605 für Kinder for children para niños pour enfants per bambini		Fig. 2 - 4 PST-24-5604 für Erwachsene for adults para adultos pour adultes per adulti		Fig. 1 - 4 PST-24-5605 für Erwachsene for adults para adultos pour adultes per adulti
Fig. 1 PST-24-5606 3.6 cm / 1 3/8" Ø 4.0 mm	Fig. 2 PST-24-5607 3.6 cm / 1 3/8" Ø 5.0 mm	Fig. 3 PST-24-5608 3.6 cm / 1 3/8" Ø 6.0 mm	Fig. 4 PST-24-5609 3.6 cm / 1 3/8" Ø 7.5 mm	
Fig. 2 - 4 PST-24-5610 for adults para adultos pour adultes per adulti		Fig. 1 - 4 PST-24-5611 for adults para adultos pour adultes per adulti		
Toynbee PST-24-5606 - PST-24-5611				

Ohrspekula

Ear Specula
Espéculos auriculares
Spéculums auriculaires
Specoli auricolari

Fig. 1 PST-24-5612 3.8 cm / 1 4/8" 5.5 x 6.5 mm	Fig. 2 PST-24-5613 3.8 cm / 1 4/8" 6.5 x 7.5 mm	Fig. 3 PST-24-5614 3.8 cm / 1 4/8" 7.5 x 8.5 mm
Fig. 4 PST-24-5615 3.8 cm / 1 4/8" 8.5 x 9.5 mm	Fig. 5 PST-24-5616 3.8 cm / 1 4/8" 9.5 x 10.5 mm	Fig. 6 PST-24-5617 3.8 cm / 1 4/8" 10.5 x 11.5 mm
Zöllner PST-24-5612 - 5618 oval, schwarz oval, black ovalado, negro ovale, noire ovale, nero		
Fig. 1 PST-24-5620 3.6 cm / 1 3/8" Ø 5.5 mm	Fig. 2 PST-24-5621 3.6 cm / 1 3/8" Ø 6.5 mm	Fig. 3 PST-24-5622 3.6 cm / 1 3/8" Ø 7.5 mm
Fig. 4 PST-24-5623 3.6 cm / 1 3/8" Ø 8.5 mm	Fig. 5 PST-24-5624 3.6 cm / 1 3/8" Ø 9.5 mm	Fig. 6 PST-24-5625 3.6 cm / 1 3/8" Ø 10.5 mm
Farrior PST-24-5620 - PST-24-5626 schwarz black negro noire nero		
Fig. 1 PST-24-5619 3.6 cm / 1 3/8" Ø 7.5 mm	Fig. 2 PST-24-5626 3.6 cm / 1 3/8" Ø 9.5 mm	Fig. 3 PST-24-5626 3.6 cm / 1 3/8" Ø 11.5 mm
Ohrspekulaständer Ear Specula Storage Rack Soporte para espéculos auriculares Support pour spéculums auriculaires Supporto per specoli auricolari		

Otologie

Otology
Otología
Otologie
Otologia

24



Quality Instruments

Stimmgabeln

Tuning Forks
Diapasónes
Diapasons
Diapason

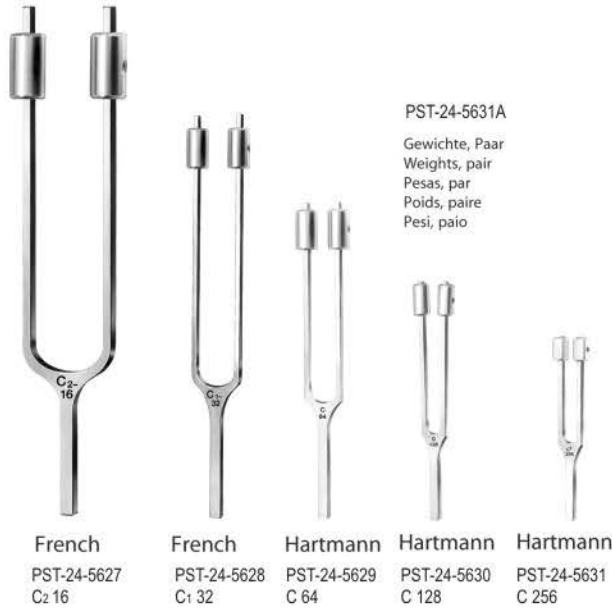

PST-24-5631A
Gewichte, Paar
Weights, pair
Pesas, par
Poids, paire
Pesi, paio

French PST-24-5627 C2 16
French PST-24-5628 C1 32
Hartmann PST-24-5629 C 64
Hartmann PST-24-5630 C 128
Hartmann PST-24-5631 C 256



Stimmgabeln

Tuning Forks
Diapasónes
Diapasons
Diapason



Martin PST-24-5632 C 128
Martin PST-24-5633 C 256
Martin-Alloy PST-24-5634 C 512
Martin-Alloy PST-24-5635 C 1024
Martin-Alloy PST-24-5636 C 2048
Hartmann PST-24-5637 C 128
Hartmann PST-24-5638 C1 256
Hartmann PST-24-5639 C2 512
Hartmann PST-24-5640 C3 1024
Hartmann PST-24-5641 C4 2048
Hartmann PST-24-5642 C5 4096



Stimmgabeln

Tuning Forks
Diapasónes
Diapasons
Diapason

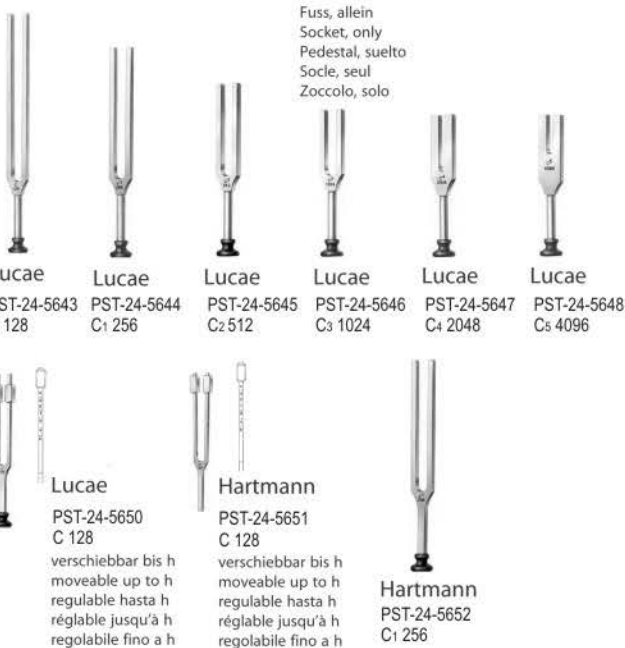

PST-24-5649
Fuss, allein
Socket, only
Pedestal, suelto
Socle, seul
Zoccolo, solo

Lucae PST-24-5643 C 128
Lucae PST-24-5644 C1 256
Lucae PST-24-5645 C2 512
Lucae PST-24-5646 C3 1024
Lucae PST-24-5647 C4 2048
Lucae PST-24-5648 C5 4096
Lucae PST-24-5650 C 128
verschiebbar bis h
moveable up to h
regulable hasta h
réglable jusqu'à h
regolabile fino a h
Hartmann PST-24-5651 C 128
verschiebbar bis h
moveable up to h
regulable hasta h
réglable jusqu'à h
regolabile fino a h
Hartmann PST-24-5652 C1 256



Stimmgabeln

Tuning Forks
Diapasones
Diapasons
Diapason



PST-24-5653
Dämpfer
Damper
Sordina
Curseur
Sordina
weiße Skala
white scale
balanza blanca
l'échelle graduée blanche
scala bianca

PST-24-5654
Dämpfer
Damper
Sordina
Curseur
Sordina
schwarze Skala
black scale
balanza negra
l'échelle graduée noir
scala nera

PST-24-5655
Rändelschraube
Knurled screw
Tornillo moleteado
Vis moletée Vite a
testa zigrinata

PST-24-5656
Gewichte, C 64
Weights, C 64
Pesas, C 64
Poids, C 64
Pesi, C 64

Rydel-Seiffert
PST-24-5653 - PST-24-5656
C 64 / C 128

auch für Neurologie
also for neurology
también para neurología
aussi pour la neurologie
anche per neurologia



Neuro
PST-24-5657
mit Hammer, Nadelrad, Pinsel und Nadel
with hammer, pinwheel, brush and needle
con martillo, rueda con espinas, cepillo y aguja
avec marteaux, roue aux épines, brosette et aiguille
con martello, algesimetro, pennello ed ago

König
PST-24-5658
A 109

verschiebbar bis g
moveable up to g
regulable hasta g
réglable jusqu'à g
regolabile fino a g

PST-24-5659
Bakelitfuss
Bakelit base
Base de Bakelit
Base di Bakelit

PST-24-5659
a1 440





Ohrkatheter, Polypenschnürer

Ear Catheters, Polypus Snares
Sondas auriculares, Polipótomos
Sondes auriculaires, Serre-noeuds
Sonde auricolari, Serranodi

Fig. 1 PST-24-5660
Fig. 2 PST-24-5661
Fig. 3 PST-24-5662

Hartmann
PST-24-5660 - PST-24-5662
15 cm / 5 7/8"

Krause-Voss
PST-24-5663
Ø 0.3 mm
PST-24-5664
Ø 0.4 mm
PST-24-5663 - PST-24-5664

Schnürdraht, Rolle mit 10 m
Snare Wire, coil of 10 m
Alambre, rollo de 10 m
Serre-noeuds, en rouleaux de 10 m
Filo in acciaio, rotolo di 10 m

PST-24-5667
Polypenschnürer
Polypus Snares
Polipótomos
Serre-noeuds
Serranodi

Krause
PST-24-5666
18.5 cm / 7 2/8"
offenes Ende
open tip
punta abierta
pointe ouverte
punta aperta

Ohrpinzetten, Ohrpolypenzangen

Ear Forceps, Ear Polypus Forceps
Pinzas auriculares, Pinzas para pólipos auriculares
Pincers auriculaires, Pincers pour polypes auriculaires
Pinze auricolari, Pinze per polipi auricolari

Jansen
PST-24-5672
16 cm / 6 2/8"

Tröltzsch (Wilde)
PST-24-5668 10.5 cm / 4 1/8"
PST-24-5669 11 cm / 4 3/8"
PST-24-5670 12.5 cm / 4 7/8"

Grünwald
PST-24-5671 14.5 cm / 5 6/8" 21.5 cm / 8 4/8"

Littauer
PST-24-5674
Schaftlänge
shaft length
longitud del vástago
longueur de la tige
lunghezza dell'asta
75 mm

Hartmann
PST-24-5675
feines Modell
delicate pattern
modelo delicado
modèle fin
modello fino

Hartmann
PST-24-5676
normales Modell
regular model
modelo regular
modèle normal
modello normale

Buck
PST-24-5677
11.5 cm / 4 4/8"
Fremdkörperzängchen
Foreign Body Lever
Elevador para cuerpos extraños
Pince pour polypes auriculaires
Pinza per corpi estranei

Quire
PST-24-5678
10.5 cm / 4 1/8"
Fremdkörperhebel
Foreign Body Lever
Elevador para cuerpos extraños
Pince pour corps étrangers
Leva per corpi estranei

Ohrpolypenzangen

Ear Polypus Forceps
Pinzas para pólipos auriculares
Pincers pour polypes auriculaires
Pinze per polipi auricolari

Hartmann-Wullstein
PST-24-5679
85 mm

Hartmann-Wullstein
PST-24-5680
1.0 mm Ø
85 mm

Hartmann
PST-24-5681
85 mm

Hartmann
PST-24-5682
85 mm 1:2

PST-24-5683
14 cm / 5 4/8"
140 mm

Hartmann-Herzfel
PST-24-5684
Ø 2.0 mm
85 mm

Hartmann
PST-24-5685
Ø 3 mm
85 mm

Strümpel
PST-24-5686
85 mm

Hartmann-Hoffmar
PST-24-5687
Ø 2.0 mm
durchschneidend
through-cutting
cortante
tranchante
tagliante
85 mm

Ohr-Knochenstanzen

Mastoid Rongeurs
Pinzas cortantes para huesos
Ostéotomes emporte-pièces
Pinze osteotomi

Citelli
PST-24-5688
2 mm
Schaftlänge
shaft length
longitud del vástago
longueur de la tige
lunghezza dell'asta
75 mm

Citelli
PST-24-5689
3 mm
Schaftlänge
shaft length
longitud del vástago
longueur de la tige
lunghezza dell'asta
75 mm

Beyer
PST-24-5690
2 mm
Schaftlänge
shaft length
longitud del vástago
longueur de la tige
lunghezza dell'asta
95 mm

Beyer
PST-24-5691
1 mm
Schaftlänge
shaft length
longitud del vástago
longueur de la tige
lunghezza dell'asta
95 mm



Ohrküretten

Ear Currettes
Curetas auriculares
Curettes auriculaires
Curette auricolari

Langenbeck
PST-24-5692
13 cm / 5 1/8"
stumpf
blunt
romo
mousse
smusso

Shapleigh
PST-24-5693 - PST-24-5694
15 cm / 5 7/8"

Buck
PST-24-5695 - PST-24-5698
17 cm / 6 5/8"
stumpf
blunt
romo
mousse
smusso

Fig. 00 PST-24-5695 Fig. 0 PST-24-5696
Fig. 1 PST-24-5697 Fig. 2 PST-24-5698

Fig. 1 PST-24-5693 Fig. 2 PST-24-5694

stumpf blunt romo mousse smusso
Fig. 000 PST-24-5699 Fig. 00 PST-24-5700 Fig. 0 PST-24-5701 Fig. 1 PST-24-5702 Fig. 2 PST-24-5703 Fig. 3 PST-24-5704

scharf sharp agudo pointu acuto
Fig. 000 PST-24-5705 Fig. 00 PST-24-5706 Fig. 0 PST-24-5707 Fig. 1 PST-24-5708 Fig. 2 PST-24-5709 Fig. 3 PST-24-5710

Buck
PST-24-5699 - PST-24-5710
17 cm / 6 5/8"



Ohrlöffel, Fremdkörperinstrumente

Ear Scoop, Foreign Body Instruments
Cucharilla auricular, Instrumentos para cuerpos extraños
Curette auriculaire, Instruments pour corps étrangers
Curetta auricolare, Strumenti per corpi estranei

Jansen
PST-24-5711
16 cm / 6 2/8"
scharf
sharp
agudo
pointu
acuto

Gross
PST-24-5712
13 cm / 5 1/8"
stumpf
blunt
romo
mousse
smusso

Weber-Loch
PST-24-5713
17 cm / 6 5/8"

Billeau
PST-24-5714 - PST-24-5716
16.5 cm / 6 4/8"

Zaufal
PST-24-5717
15 cm / 5 7/8"
Fremdkörperheber
Foreign Body Lever
Elevador para cuerpos extraños
Anse auriculaire
Leva per corpi estranei

Hartmann
PST-24-5718
16 cm / 6 2/8"
Ohrhäkchen
Ear Hooklet
Ganchito auricular
Lever pour corps étrangers
Uncino auricolare

Lucae
PST-24-5719 - 5721
14 cm / 5 4/8"

Fig. 1 PST-24-5714 Fig. 2 PST-24-5715 Fig. 3 PST-24-5716

Fig. 1 PST-24-5719 Fig. 2 PST-24-5720 Fig. 3 PST-24-5721



Ohrhäkchen, Trommelfellnadeln

Ear Hooklet, Tympanum Needles
Ganchito auricular, Aguja para tímpano
Lever pour corps étrangers, Instruments pour corps étrangers
Uncino auricolare, Strumenti per corpi estranei

Fig. 1 PST-24-5722 Fig. 2 PST-24-5723 Fig. 3 PST-24-5724 Fig. 4 PST-24-5725 PST-24-5729

Fig. 5 PST-24-5726 Fig. 6 PST-24-5727 Fig. 7 PST-24-5728 PST-24-5730

Wagener
PST-24-5722 - PST-25-5143
14 cm / 5 4/8"

Day
PST-24-5729 - PST-24-5730
17 cm / 6 5/8"

Politzer
PST-24-5731 PST-24-5732 PST-24-5733
17.5 cm / 6 7/8" 15.5 cm / 6 1/8" 16 cm / 6 2/8"

Lucae
PST-24-5734 PST-24-5735
18 cm / 7 1/8" 17.5 cm / 6 7/8"



Ohrspatzen, Ohrlöffel

Ear Periosteal Elevators, Ear Scoop
Legras auriculares, Cucharilla auricular
Rugines-raspatoires auriculaires, Rugine-raspatoire auriculaire
Raspatori auricolari, Curetta auricolare

6 mm 6 mm

Lempert
PST-24-5736
20.5 cm / 8 1/8"

Lempert
PST-24-5737
18 cm / 7 1/8"

Fig. 1 PST-24-5738 Fig. 2 PST-24-5739 Fig. 3 PST-24-5740 Fig. 4 PST-24-5741 Fig. 5 PST-24-5742

Lempert
PST-24-5738 - PST-24-5742
21.5 cm / 8 4/8"
scharf
sharp
agudo
pointu
acuto



Otologie

Otology
Otología
Otologie
Otologia

24



Quality Instruments

Ohrspritzen

Ear Syringes
Jeringas auriculares
Seringues auriculaires
Siringhe auricolari



PST-24-5743

selbstfüllend
in Kunststofftasche
self filling
in plastic pouch
auto-riellena
en bolsa plástica
à remplissage automatique
auto-riempente
in borsa di plastica

PST-24-5744

Gummidichtung
Rubber gasket
Junta de goma
Joint de caoutchouc
Guarnizione di gomma

PST-24-5745

Rückhaltefeder
Retention spring
Muelle de retención
Ressort de rétention
Molla di ritenzione

PST-24-5746

Verbindungsschlauch
Flexible Tube
Tubo de conexión
Tube de connection
Tubo di connessione



PST-24-5747
Gewindeansatz
Threaded Tip
Punta de rosca
Pointe fileté
Punta filettata



PST-24-5748
Saugansatz
Suction Nozzle
Pieza de succión
Embout à aspiration
Aspiratore



PST-24-5749
Schutzeller
Protecting Disc
Disco protector
Plaque de protection
Disco protettivo



PST-24-5750
Ventilaufsatz
Valve Attachment
Válvula de conexión
Soupape
Valvola di connessione



PST-24-5751
Konischer Ansatz
Conical Tip
Punta cónica
Pointe conique
Punta conica



PST-24-5752
Geknöpfter Ansatz
Button ended Tip
Punta de botón
Pointe boutonnée
Punta a bottone



PST-24-5753
Metallolive
Metal Olive
Oliva metálica
Olive en métal
Oliva in metallo

Ohrspritzen

Ear Syringes
Jeringas auriculares
Seringues auriculaires
Siringhe auricolari

PST-24-5754

Spülansatz
Irrigation adapter
Adaptador de irrigación
Adaptateur à irrigation
Adattatore per lavaggio

PST-24-5755

Spülansatz
Irrigation adapter
Adaptador de irrigación
Adaptateur à irrigation
Adattatore per lavaggio

PST-24-5756
50 ml

komplett mit Teller und 2 Ansätzen
complete with protection disc and 2 tips
completo con disco protector y 2 puntas
complet avec plaque de protection et 2 pointes
completo con disco protettivo e 2 punte

PST-24-5758
100 ml

komplett mit Teller und 2 Ansätzen
complete with protection disc and 2 tips
completo con disco protector y 2 puntas
complet avec plaque de protection et 2 pointes
completo con disco protettivo e 2 punte

PST-24-5757

Ohrspritze
Ear Syringe
Jeringa auricular
Seringue auriculaire
Siringa auricolare

Nasenspekula

Nasal Specula
Espéculos nasales
Spéculums nasaux
Specoli nasali



Goldsmith (Thudichum)

PST-24-5759 - PST-24-5761
6.5 cm / 2 4/8"



Fig. 1
PST-24-5759
Blätter
blades
hojas
lames
lame

21.0 x 9.5 mm

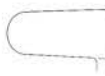

Fig. 2
PST-24-5760
Blätter
blades
hojas
lames
lame

21.0 x 10.5 mm



Fig. 3
PST-24-5761
Blätter
blades
hojas
lames
lame

21.0 x 11.5 mm



Hartmann-Halle

PST-24-5762 - PST-24-5764
16 cm / 6 2/8"



Fig. 1
PST-24-5762
Blätter
blades
hojas
lames
lame
27 mm



Fig. 2
PST-24-5763
Blätter
blades
hojas
lames
lame
31 mm



Fig. 3
PST-24-5764
Blätter
blades
hojas
lames
lame
35 mm

Nasenspekula

Nasal Specula
Espéculos nasales
Spéculums nasaux
Specoli nasali



Martin

PST-24-5765
13 cm / 5 1/8"

Blätter
blades
hojas
lames
lame
17mm



Martin

PST-24-5766
13 cm / 5 1/8"

Blätter
blades
hojas
lames
lame
17mm



Teick-Halle

PST-24-5767
13 cm / 5 1/8"

Blätter
blades
hojas
lames
lame
16mm



Killian

PST-24-5768 - PST-24-5771



Fig. 1
PST-24-5768
14 cm / 5 4/8"
35 mm



Fig. 2
PST-24-5769
14 cm / 5 4/8"
50 mm



Fig. 3
PST-24-5770
16 cm / 6 2/8"
75 mm

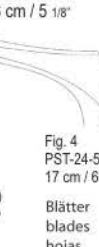

Fig. 4
PST-24-5771
17 cm / 6 6/8"

Blätter
blades
hojas
lames
lame
85 mm



Nasenspekula

Nasal Specula
Especulos nasales
Spéculums nasaux
Specoli nasali



Mod. Wien
PST-24-5772
13.5 cm / 5 3/8"

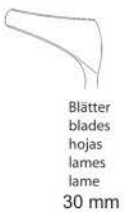

Blätter
blades
hojas
lames
lame
30 mm

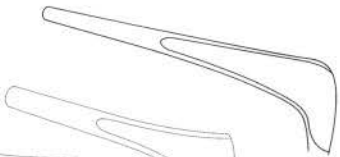

Fig. 4
PST-24-5776
16 cm / 6 2/8"



Fig. 1
PST-24-5773
13.5 cm / 5 3/8"
35 mm



Fig. 2
PST-24-5774
14 cm / 5 4/8"
50 mm



Fig. 3
PST-24-5775
16 cm / 6 2/8"
75 mm

Cottle
PST-24-5773 - PST-24-5776



Nasenspekula

Nasal Specula
Especulos nasales
Spéculums nasaux
Specoli nasali

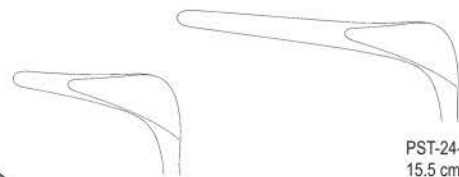

PST-24-5777
14 cm / 5 4/8"
Blätter
blades
hojas
lames
lame
45 mm



PST-24-5778
15.5 cm / 6 1/8"
Blätter
blades
hojas
lames
lame
75 mm

Cottle
PST-24-5777 - PST-24-5778



Polypenschnürer

Polypus Snares
Polipótomos
Serre-noeuds pour polypes
Serranodi per polipi



Ø 3mm



Ø 3mm



PST-24-5781 - 5782



PST-24-5783
10.5 cm / 4"

Schnürdraht
Snare Wire
Asas de alambre
Anses en fil d'acier
Filo per allacciare
0,3 mm Ø
Bündel mit 12 Stück
bundle with 12 pieces
12 piezas atados
paquet de 12 pièces
confezione di 12 pezzi

Schnürdraht
Snare Wire
Asa de alambre
Anse en fil d'acier
Filo per allacciare

Rolle mit 10 m
coil of 10 m
rollo de 10 m
en rouleaux de 10 m
rotolo di 10 m

PST-24-5781 Ø 0.3 mm PST-24-5782 Ø 0.4 mm

Krause

PST-24-5779
26 cm / 10 2/8"
Schaft
shaft
vástago
tige
asta

Krause-Voss

PST-24-5780
26 cm / 10 2/8"
Schaft
shaft
vástago
tige
asta



PST-24-5784
Douglas Rectal Snare
(Norwood) 12" Working Length



PST-24-5785
Krause Nasal Snare, Large
Cannula, Stylet, 10.4in
26.5 cm



PST-24-5786
LEWIS SNARE
10 1/4" (26 cm)



Rhinologie

Rhinologie
Rinología
Rhinologia
Rinologia

25



Quality Instruments

Nasentamponpinzetten, Nasentamponzangen

Nasal Tampon Forceps, Nasal Tampon Forceps
Pinzas para taponamiento, Pinzas para taponamiento
Pincès à pansements, Pincès à pansements
Pinze per medicature, Pinze per medicature

Trörltsch
PST-25-5801
14.5 cm / 5 7/8"

Trörltsch
PST-25-5802
15.5 cm / 6 1/8"

Grünwald (Jansen)
PST-25-5803
21.5 cm / 8 4/8"

Westmacott
PST-25-5804
20 cm / 7 7/8"

Lubet-Barbon
PST-25-5805
18.5 cm / 7 2/8"

Hartmann
PST-25-5806
18.5 cm / 7 2/8"
Nasenpolypenzange
Nasal Polypus Forceps
Pinza para pólipos nasales
Pinze à polypes nasaux
Pinza per polipi nasali

Septumzangen

Septum Forceps
Pinzas para tabique nasal
Pincès pour la cloison nasale
Pinze per il setto nasale

PST-25-5809
links gebogen
left curved
curvo por izquierdo
courbé à gauche
curvo a sinistra

PST-25-5810
rechts gebogen
right curved
curvo por derecho
courbé à droite
curvo a destra

PST-25-5809 - PST-25-5810
15.5 cm / 6 1/8"

Knight
PST-25-5807
17 cm / 6 6/8"

Graig
PST-25-5808
16 cm / 6 2/8"

Fig. 1
PST-25-5811

Fig. 2
PST-25-5812

Luc
PST-25-5811 - 5812
Siebbeinzange
Ethmoid Bone Forceps
Pinza para etmoides
Pinze éthmoidale
Pinza etmoidale

Fig. 1
PST-25-5813

Fig. 2
PST-25-5814

Fig. 3
PST-25-5815

Fig. 4
PST-25-5816

Brünings
PST-25-5813 - PST-25-5816
16.5 cm / 6 4/8"

Siebbeinzangen

Ethmoid Bone Forceps
Pinzas para etmoides
Pincès éthmoidales
Pinze etmoidali

PST-25-5817 - PST-25-5818
120 mm
gerade
straight
recta
droite
diritta

PST-25-5818
aufgebogen
curved upwards
curva por arriba
courbée en haut
curva in alto

Weil
PST-25-5819
120 mm

Watson-Williams
PST-25-5820

Takahashi
PST-25-5819 - PST-25-5821
120 mm

PST-25-5821

Scharfe Nasenzangen, Siebbeinzangen

Nasal Cutting Forceps, Ethmoid Bone Forceps
Pinzas nasales cortantes, Pinzas para etmoides
Pincès nasales coupantes, Pincès éthmoidales
Pinze taglianti per il naso, Pinze etmoidali

Fig. 1
PST-25-5822
3.0 mm

Fig. 2
PST-25-5823
3.5 mm

Fig. 3
PST-25-5824
4.5 mm

Fig. 4
PST-25-5825
5.5 mm

Fig. 5
PST-25-5826
6.0 mm

Weil-Blakesley
PST-25-5822 - PST-25-5826
125 mm

Fig. 1
PST-25-5827
3.0 mm

Fig. 2
PST-25-5828
3.5 mm

Fig. 3
PST-25-5829
4.5 mm

Fig. 4
PST-25-5830
5.0 mm

Weil-Blakesley
PST-25-5827 - PST-25-5830
45°
120 mm



Scharfe Nasenzangen, Siebbeinzangen

Nasal Cutting Forceps, Ethmoid Bone Forceps
Pinzas nasales cortantes, Pinzas para etmoides
Pincas nasales coupantes, Pincas éthmoidales
Pinze taglianti per il naso, Pinze etmoidali



Antrumstanzen, Scharfe Nasenzangen

Antrum Punches, Nasal Cutting Forceps
Pinzas sacabocadas para seno maxilar, Pinzas nasales cortantes
Pincas emporte-pièces pour sinus maxillaire, Pincas nasales coupantes
Pinze taglianti per seno mascellare, Pinze taglianti per il naso



retrograd aufwärts schneidend retrograde, up cutting
retrograde, right cutting
retrogrado, cortante en haut
retrogrado, taglio in sù

retrograd rechts schneidend retrograde, right cutting
retrogrado, cortante a la derecha
retrograde, coupant à droit
retrogrado, taglio destro

retrograd links schneidend retrograde, left cutting
retrogrado, cortante a la izquierda
retrograde, coupant à gauche
retrogrado, taglio sinistro



Schmienden
PST-25-5844
8.0 mm



Septumzangen, Septumquetschzange

Septum Forceps, Septum Morselizer
Pinzas para tabique nasal, Pinza para aplastamiento
Pincas pour la cloison nasale, Pince-gouge pour la cloison nasale
Pinze per il setto nasale, Pinza contundente per il setto nasale



Septumquetschzangen

Septum Morselizers
Pinzas para aplastamiento
Pincas-gouge pour la cloison nasale
Pinze contundente per il setto nasale



Rhinologie

Rhinologie
Rinología
Rhinologia
Rinologia

25



Quality Instruments

Keilbeinstanzen

Sphenoid Bone Punches
Pinzas sacabocadas para esfenoides
Pincas emporte-pièces pour sinus sphéno?dal
Pinze taglianti per seno sfenoidale



Hajek
PST-25-5852 - PST-25-5855



PST-25-5852
aufwärts schneidend
up cutting
cortante por arriba
tranchant en haut
tagliante in alto
40 x 40 mm

Schaftlänge
shaft length
longitud del vástago
longueur de la tige
lunghezza dell'asta
140 mm

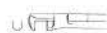

PST-25-5853
abwärts schneidend
down cutting
cortante por abajo
tranchant en bas
tagliante in basso
40 x 40 mm

Schaftlänge
shaft length
longitud del vástago
longueur de la tige
lunghezza dell'asta
145 mm



PST-25-5854
3,5 x 3,5 mm
140 mm



PST-25-5855
3,5 x 3,5 mm
140 mm



PST-25-5856
aufwärts schneidend
up cutting
cortante por arriba
tranchant en haut
tagliante in alto
3,0 x 3,0 mm



PST-25-5857
abwärts schneidend
down cutting
cortante por abajo
tranchant en bas
tagliante in basso
3,0 x 3,0 mm

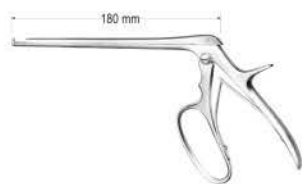

Ferris-Smith-Kerrison
PST-25-5856 - PST-26-5257

Keilbeinstanzen

Sphenoid Bone Punches
Pinzas sacabocadas para esfenoides
Pincas emporte-pièces pour sinus sphéno?dal
Pinze taglianti per seno sfenoidale



Ferris-Smith-Kerrison
PST-25-5858 - PST-25-5859

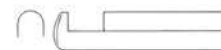

PST-25-5858
aufwärts schneidend
up cutting
cortante por arriba
tranchant en haut
tagliante in alto
5.0 x 5.0 mm

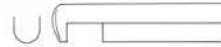

PST-25-5859
abwärts schneidend
down cutting
cortante por abajo
tranchant en bas
tagliante in basso
5.0 x 5.0 mm

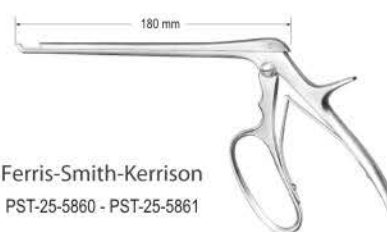

Ferris-Smith-Kerrison
PST-25-5860 - PST-25-5861



PST-25-5860
3mm
schräg vorwärts schneidend
obliquely forward cutting
cortante oblicuo hacia adelante
tranchant oblique en avant
tagliante obliquo in avanti



PST-25-5861
5mm

Keilbeinstanzen

Sphenoid Bone Punches
Pinzas sacabocadas para esfenoides
Pincas emporte-pièces pour sinus sphéno?dal
Pinze taglianti per seno sfenoidale

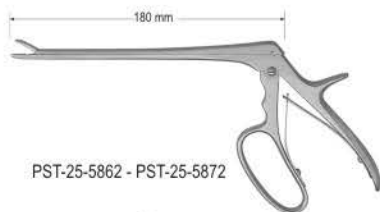

PST-25-5862 - PST-25-5872



PST-25-5862
10 x 2 mm



PST-25-5867
10 x 2 mm



PST-25-5870
10 x 2 mm

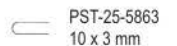

PST-25-5863
10 x 3 mm

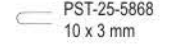

PST-25-5868
10 x 3 mm

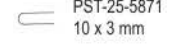

PST-25-5871
10 x 3 mm

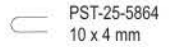

PST-25-5864
10 x 4 mm

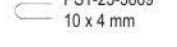

PST-25-5869
10 x 4 mm

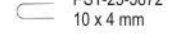

PST-25-5872
10 x 4 mm

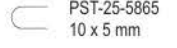

PST-25-5865
10 x 5 mm

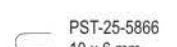

PST-25-5866
10 x 6 mm

Antrumstanzen

Antrum Punches
Pinzas sacabocadas para seno maxilar
Pincas emporte-pièces pour sinus maxillaire
Pinze taglianti per seno mascellare



PST-25-5873
3 x 3 mm

PST-25-5874
4 x 4 mm

PST-25-5875
5 x 5 mm

PST-25-5876
6 x 6 mm



Kerrison
PST-25-5873 - PST-25-5876

aufwärts schneidend
up cutting
cortante por arriba
tranchant en haut
tagliante in alto

Rhinologie

Rhinologie
Rhinología
Rhinologia
Rinologia

25



Quality Instruments

Rhinoplastik-Messer

Rhinoplastic Knives
Cuchillos rinoplásticos
Couteaux pour plastie du nez
Bisturi per plastica nasale

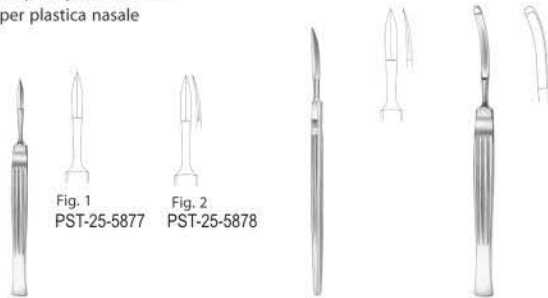

Joseph
PST-25-5877 - PST-25-5878
15 cm / 5 7/8"

Fomon
PST-25-5879
16.5 cm / 6 4/8"

Converse
PST-25-5880
16 cm / 6 2/8"

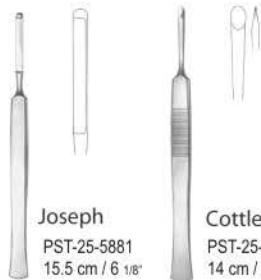

Joseph
PST-25-5881
15.5 cm / 6 1/8"

Cottle
PST-25-5882
14 cm / 5 4/8"



Septummesser, Schwingmesser

Septum Knives, Swivel Knives
Cuchillos para tabique nasal
Bistouris pour la cloison nasale
Bisturi per il setto nasale



Mukosamesser
Mucosa Knife
Cuchillo para mucosa
Couteau pour muqueuse
Bisturi per mucosa
PST-25-5883
16.5 cm / 6 4/8"

Freer
PST-25-5884
19 cm / 7 4/8"

Freer
PST-25-5885
18.5 cm / 7 2/8"

Freer

PST-25-5883
16.5 cm / 6 4/8"

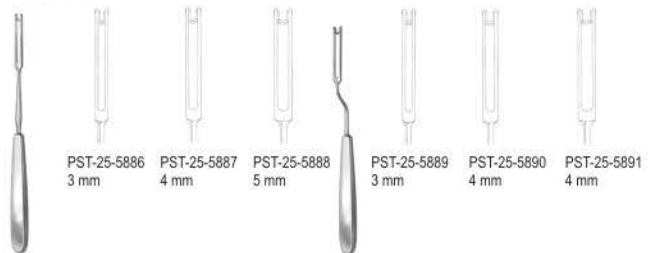

Ballenger
PST-25-5886 - PST-25-5888
21 cm / 8 2/8"

Ballenger
PST-25-5889 - PST-25-5891
20.5 cm / 8 1/8"



Septumelevatorien

Septum Elevators
Elevadores para tabique nasal
Elévateurs pour la cloison nasale
Elevatori per il setto nasale



Brünings

PST-25-5892
16.5 cm / 6 4/8"

McKenty
PST-25-5893 - 5894
15 cm / 5 7/8"

Halle
PST-25-5895
16 cm / 6 2/8"

Joseph
PST-25-5896
16.5 cm / 6 4/8"

Septummesser
Septum Knife

Cuchillo para tabique nasal
Bistouri pour la cloison nasale
Bisturi per il setto nasale

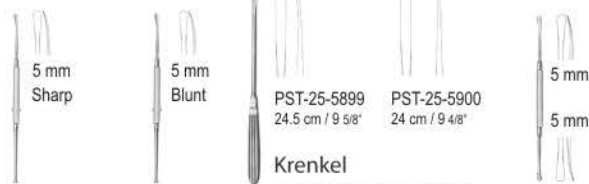

Freer
PST-25-5897
19 cm / 7 4/8"

Freer
PST-25-5898
19 cm / 7 4/8"

Krenkel
PST-25-5899 - PST-25-5900
Gaumenraspatorium
Cleft Palate Periosteal Rasapatory
Legra para el paladar
Raspatoir pour palais
Raspatore per palato

Freer
PST-25-5901
18 cm / 7 1/8"



Septumelevatorien

Septum Elevators
Elevadores para tabique nasal
Elévateurs pour la cloison nasale
Elevatori per il setto nasale



Freer
PST-25-5902
18 cm / 7 1/8"

Freer
PST-25-5903
21 cm / 8 2/8"

McKenty
PST-25-5904
20.5 cm / 8 1/8"

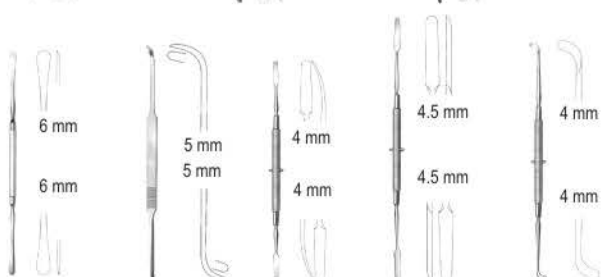

Ballenger-Hajek
PST-25-5905
19 cm / 7 4/8"

Cottle
PST-25-5906
23.5 cm / 9 2/8"

Killian
PST-25-5907
18 cm / 7 1/8"

Killian
PST-25-5908
23 cm / 9"

Pennington
PST-25-5909
21.5 cm / 8 4/8"



Rhinologie

Rhinologie
Rhinología
Rhinologia
Rinologia

25



Quality Instruments

Periostelevatorien

Periosteal Elevators
Legras para periostio
Elévateurs pour le périoste
Elevatori per il periostio

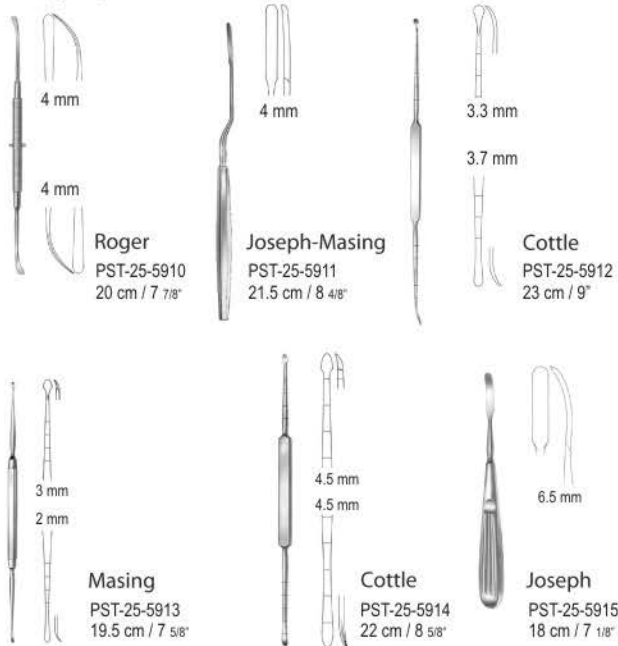

Septummeißel, Septum-Hohlmeißel

Septum Chisels, Septum Gouges
Cinceles para tabique nasal, Gubias para tabique nasal
Elévateurs pour le périoste, Gouges pour la cloison nasale
Elevatori per il periostio, Sgorbie per il setto nasale



Osteotome

Osteotomes
Osteótomos
Ostéotomes
Osteotomi

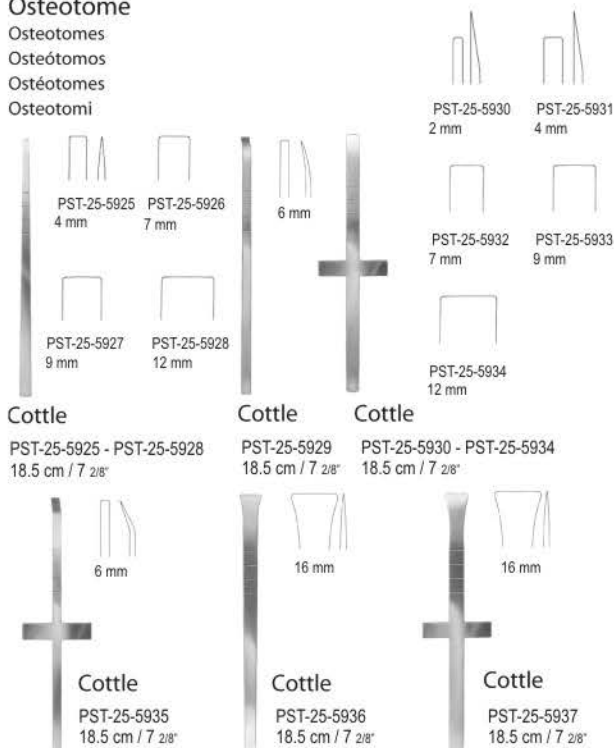

Osteotome, Meißel

Osteotomes, Chisels
Osteótomos, Cinceles
Ostéotomes, Ciseaux-burins
Osteotomi, Scalpelli

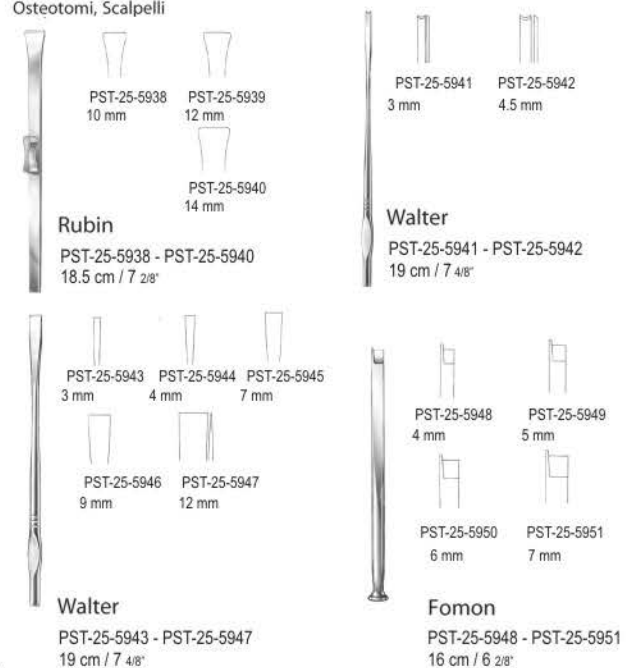

Rhinologie

Rhinologie
Rinología
Rhinologia
Rinologia

25



Quality Instruments

Nasenmeißel, Meißel

Rhinoplastic Chisels, Chisels
Cinceles nasales, Cinceles
Ciseaux-burins nasaux, Ciseaux-burins
Scalpelli nasali, Scalpelli

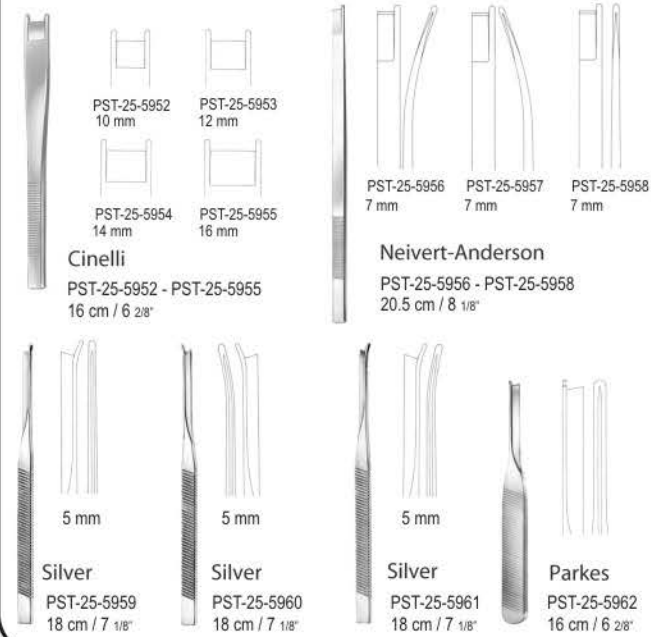

PST-25-5952 10 mm
PST-25-5953 12 mm

PST-25-5954 14 mm
PST-25-5955 16 mm

Cinelli

PST-25-5952 - PST-25-5955
16 cm / 6 2/8"

PST-25-5956 7 mm
PST-25-5957 7 mm
PST-25-5958 7 mm

Neivert-Anderson

PST-25-5956 - PST-25-5958
20.5 cm / 8 1/8"

Silver

PST-25-5959
18 cm / 7 1/8"

Silver

PST-25-5960
18 cm / 7 1/8"

Silver

PST-25-5961
18 cm / 7 1/8"

Parkes

PST-25-5962
16 cm / 6 2/8"



Nasensägen

Nasal Saws
Sierras nasales
Scies nasales
Seghe nasali

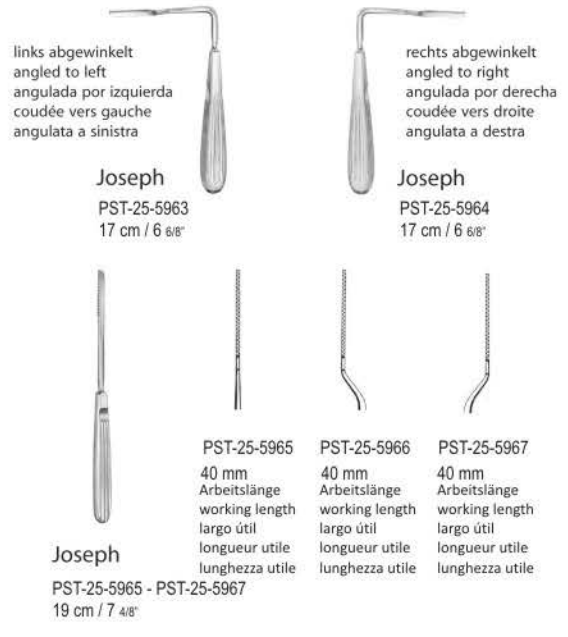

links abgewinkelt
angled to left
angulada por izquierda
coudée vers gauche
angulata a sinistra

rechts abgewinkelt
angled to right
angulada por derecha
coudée vers droite
angulata a destra

Joseph

PST-25-5963
17 cm / 6 6/8"

Joseph

PST-25-5964
17 cm / 6 6/8"

Joseph

PST-25-5965 - PST-25-5967
19 cm / 7 4/8"

PST-25-5965
40 mm
Arbeitslänge
working length
largo útil
longueur utile
lunghezza utile

PST-25-5966
40 mm
Arbeitslänge
working length
largo útil
longueur utile
lunghezza utile

PST-25-5967
40 mm
Arbeitslänge
working length
largo útil
longueur utile
lunghezza utile



Knorpelquetsche

Cartilage Crusher
Machacadora
Pincès-gouge à cartilage
Torchio per cartilagine



Cottle

PST-25-5968
12 cm / 4 6/8"

Griff
Handle
Mango
Manche
Manico

Cottle

PST-25-5969

Führungshilfe für Osteotome
Guide Support for osteotomes
Soporte de guía para osteotomos
Support conducteur pour ostéotomes
Supporto di guida per osteotomi

7 mm breit
7 mm wide
7 mm de ancho
largeur 7 mm
larghezza 7 mm

Cottle

PST-25-5970

Knorpelquetsche
Cartilage Crusher
Machacadora
Pincès-gouge à cartilage
Torchio per cartilagine

65 x 30 x 30 mm



Nasenraspeln, Knochenfeilen, Antrumraspeln

Nasal Rasps, Bone Files, Antrum Rasps
Escofinas nasales, Limas para huesos, Escofinas para el antro
Râpes nasales, Limes à os, Râpes pour antre
Raspe nasali, Lime per ossa, Raspe per seno mascellare

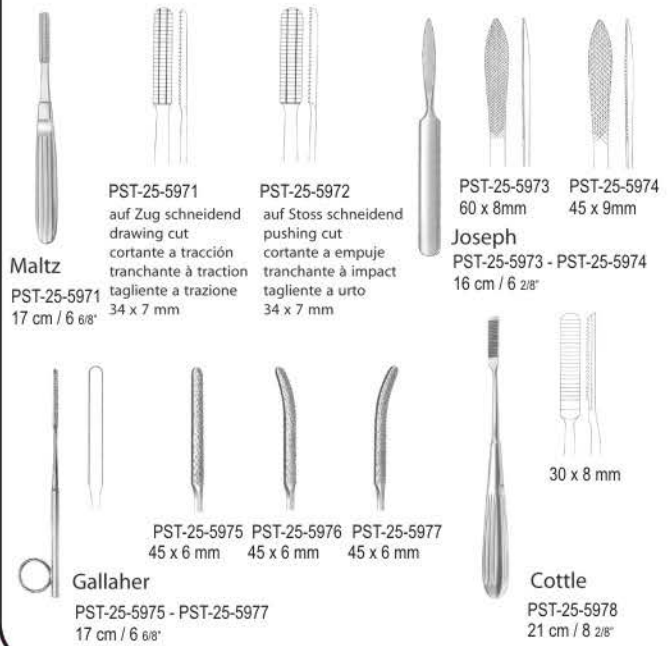

PST-25-5971
auf Zug schneidend
drawing cut
cortante a tracción
tagliante a trazione

Maltz

PST-25-5971
17 cm / 6 6/8"

34 x 7 mm

PST-25-5972
auf Stoss schneidend
pushing cut
cortante a empuje
tagliante a urto

PST-25-5972
34 x 7 mm

PST-25-5973
60 x 8mm

PST-25-5974
45 x 9mm

Joseph

PST-25-5973 - PST-25-5974
16 cm / 6 2/8"

Gallaher

PST-25-5975 - PST-25-5977
17 cm / 6 6/8"

PST-25-5975
45 x 6 mm

PST-25-5976
45 x 6 mm

PST-25-5977
45 x 6 mm

Cottle

PST-25-5978
21 cm / 8 2/8"

30 x 8 mm



Rhinologie

Rhinologie
Rinología
Rhinologia
Rinologia

25



Quality Instruments

Glabellaraspeln, Nasenraspeln

Glabella Rasps, Nasal Rasps
Escofinas para glabella, Escofinas nasales
Râpes pour la glabelle, Râpes nasales
Raspe per glabella, Raspe nasali



PST-25-5979
auf Stoss schneidend
pushing cut
cortante a empuje
tranchante à impact
tagliante a urto
32 x 9 mm

PST-25-5980
auf Zug schneidend
drawing cut
cortante a tracción
tranchante à traction
tagliante a trazione
32 x 9 mm

PST-25-5981
auf Stoss schneidend
pushing cut
cortante a empuje
tranchante à impact
tagliante a urto
15 x 8 mm

PST-25-5982
auf Zug schneidend
drawing cut
cortante a tracción
tranchante à traction
tagliante a trazione
15 x 8 mm

Aufricht
PST-25-5979 - 5980
21 cm / 8 2/8"

Lewis
PST-25-5981 - PST-25-5982
19 cm / 7 4/8"

Fomon
PST-25-5983
21 cm / 8 2/8"

Nasenraspeln

Nasal Rasps
Escofinas nasales
Râpes nasales
Raspe nasali

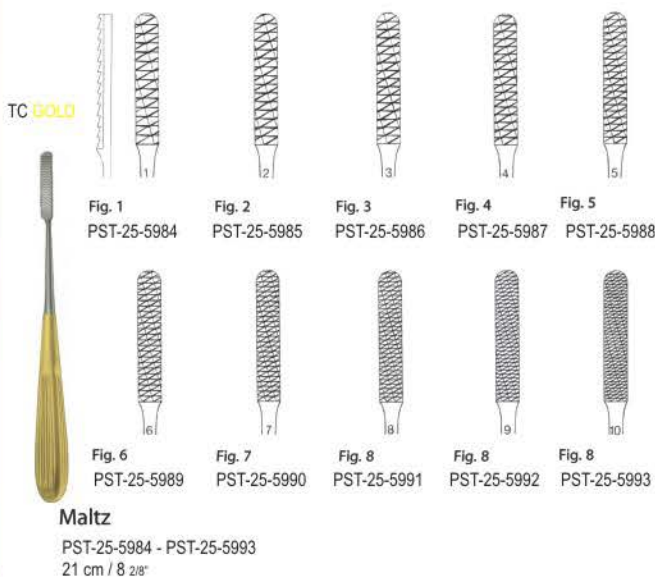

TC GOLD

Fig. 1
PST-25-5984

Fig. 2
PST-25-5985

Fig. 3
PST-25-5986

Fig. 4
PST-25-5987

Fig. 5
PST-25-5988

Fig. 6
PST-25-5989

Fig. 7
PST-25-5990

Fig. 8
PST-25-5991

Fig. 8
PST-25-5992

Fig. 8
PST-25-5993

Maltz

PST-25-5984 - PST-25-5993
21 cm / 8 2/8"

Nasenraspeln

Nasal Rasps
Escofinas nasales
Râpes nasales
Raspe nasali

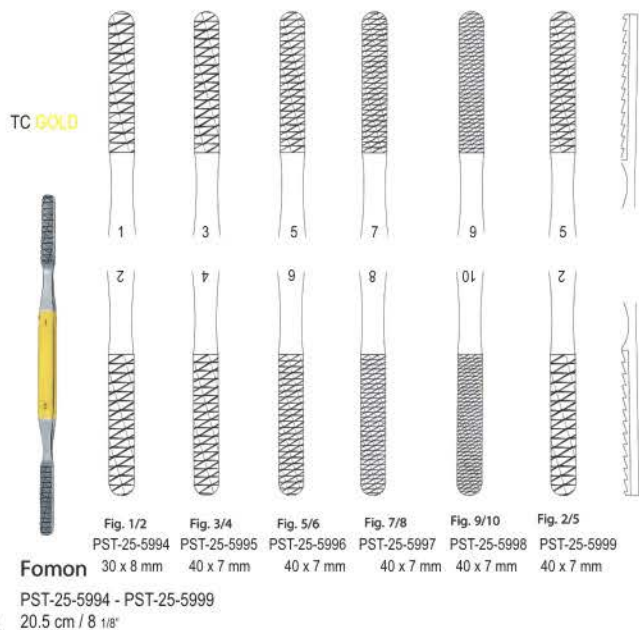

TC GOLD

Fig. 1/2

PST-25-5994

Fomon
PST-25-5994 - PST-25-5999
20.5 cm / 8 1/8"

Fig. 3/4

PST-25-5995

Fig. 5/6

PST-25-5996

Fig. 7/8

PST-25-5997

Fig. 9/10

PST-25-5998

Fig. 2/5

PST-25-5999

Nasenhäkchen

Nasal Hooklets
Ganchitos nasales
Crochets nasaux
Uncini nasali

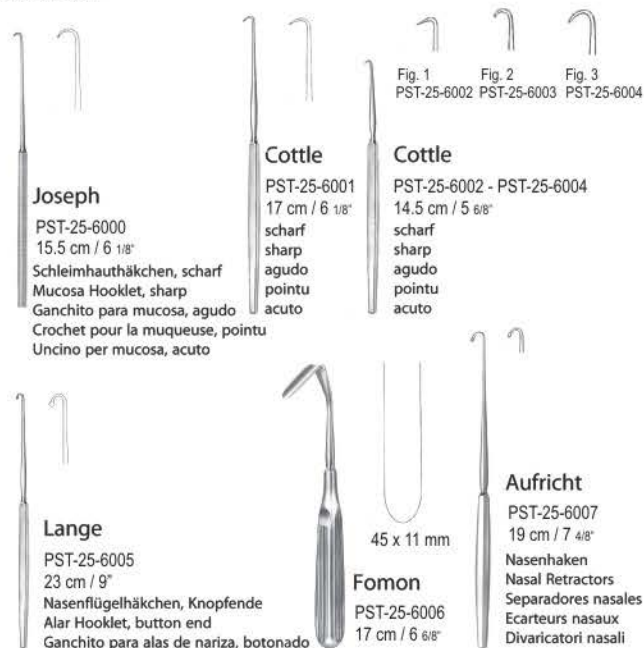

Joseph

PST-25-6000
15.5 cm / 6 1/8"

Schleimhauthäkchen, scharf
Mucosa Hooklet, sharp
Ganchito para mucosa, agudo
Crochet pour la muqueuse, pointu
Uncino per mucosa, acuto

Cottle
PST-25-6001
17 cm / 6 1/8"

scharf
sharp
agudo
pointu
acuto

Cottle
PST-25-6002 - PST-25-6004
14.5 cm / 5 8/8"

scharf
sharp
agudo
pointu
acuto

Lange

PST-25-6005
23 cm / 9"

Nasenflügelhäkchen, Knopfende
Alar Hooklet, button end
Ganchito para alas de nariz, botonado

Fomon

PST-25-6006
17 cm / 6 6/8"

Aufricht

PST-25-6007
19 cm / 7 4/8"

Nasenhaken
Nasal Retractors
Separadores nasales
Ecarteurs nasaux
Divaricatori nasali



Nasenflügelhäkchen, Schleimhauthäkchen

Alar Hooklets, Mucosa Hooklet
Ganchitos para alas de nariz, Ganchito para mucosa
Crochets pour les ailes du nez, Crochet pour la muqueuse
Uncini per le pinne nasali, Uncino per mucosa



Kilner
PST-25-6008
8 cm / 3 1/8"
scharf
sharp
agudo
pointu
acuto



Converse
PST-25-6009
10.5 cm / 4 1/8"
Nasenhaken
Nasal Retractors
Separadores nasales
Ecarteurs nasaux
Divaricatori nasali



Converse
PST-25-6010
11.5 cm / 4 4/8"
scharf
sharp
agudo
pointu
acuto



Freer

PST-25-6011
15 cm / 5 7/8"
scharf
sharp
agudo
pointu
acuto

Joseph

PST-25-6012 - PST-25-6015
16 cm / 6 1/8"

Fomon

PST-25-6016
16 cm / 6 2/8"
geknöpft
button ended
abotonado
boutonné
a bottone

Nasenflügelhäkchen, Nasenhaken

Alar Hooklets, Nasal Retractors
Ganchitos para alas de nariz, Separadores nasales
Crochets pour les ailes du nez, Ecarteurs nasaux
Uncini per le pinne nasali, Divaricatori nasali



Cottle-Neivert
PST-25-6017
19.5 cm / 7 5/8"

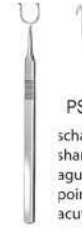

Cottle
PST-25-6018 - PST-25-6020
14.5 cm / 5 6/8"

PST-25-6018
scharf
sharp
agudo
pointu
acuto

PST-25-6019
stumpf/scharf
blunt/sharp
romo/agudo
mousse/aiguë
smusso/acuto

PST-25-6020
scharf/stumpf
sharp/blunt
agudo/romo
aiguë/mousse
acuto/smusse



Cottle
PST-25-6021
14 cm / 5 4/8"

Blätter
blades
hojas
lames
lame
60 x 6,5 mm



Neivert
PST-25-6022
17 cm / 6 6/8"

Cottle

PST-25-6023
14 cm / 5 4/8"
Sattelhäkchen
Saddle Hook
Separador en forma de silla
Élévateur sous forme de selle
Elevatori in forma di sella



Cottle
PST-25-6024
16 cm / 6 2/8"



Aufrecht
PST-25-6025
12 cm / 4 6/8"

stumpf
blunt
romo
mousse
smusso

Septumzangen, Septumrichtzangen

Septum Forceps, Septum Straightening Forceps
Pinzas para tabique nasal, Pinzas para enderezar el tabique nasal
Pincers pour la cloison nasale, Pincers pour le redressement de la cloison nasale
Pinze per il setto nasale, Pinze per raddrizzare il setto nasale



Kressner
PST-25-6026
22 cm / 8 5/8"



Cottle-Walsham
PST-25-6027 - PST-25-6029
23 cm / 9"

PST-25-6027
gerade
straight
recta
droite
diritta

PST-25-6028
links
left
izquierdo
gauche
sinistra

PST-25-6029
rechts
right
derecho
droit
destra



Asch
PST-25-6030
22.5 cm / 8 7/8"

Hautfasspinzetten

Skin Grasping Forceps
Pinzas para piel
Pincers pour saisir la peau
Pinze per afferrare la pelle



Aiach
PST-25-6031
15.5 cm / 6 1/8"

Columella-Nahtpinzette
Columella Suturing Forceps
Pinza para suturar la columella
Pince pour suturer la columelle
Pinza per suturare columella



Ogura
PST-25-6032
11 cm / 4 3/8"



Cottle
PST-25-6033
14 cm / 5 4/8"
mit Zähnchen
with teeth
con dientes
avec dents
con denti



Cottle
PST-25-6034
11 cm / 4 3/8"
Columellapinzette
Columella Forceps
Pinza para columella
Pinza à columella
Pinza per columella



Rhinologie

Rhinologie
Rinología
Rhinologia
Rinologia

25



Quality Instruments

Antrumküretten

Antrum Curettes
Curetas para el antro
Curettes pour l'antre
Curette per antro

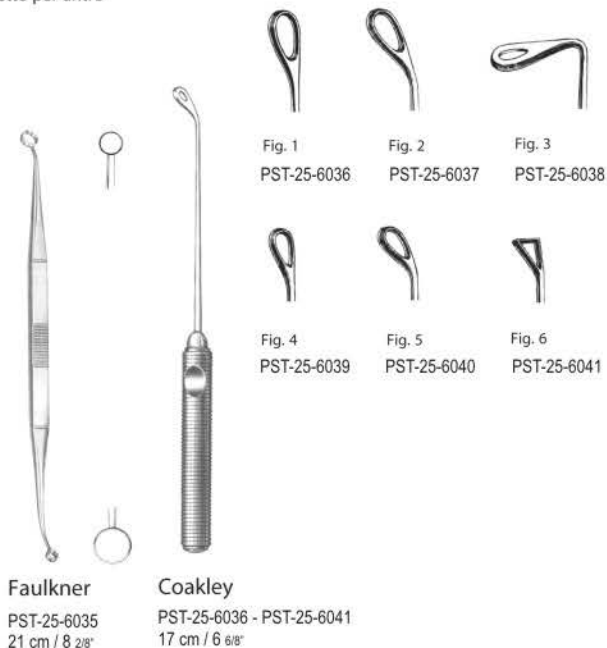

Saugraspatorium, Sinus-Dilatatoren

Suction Raspatorary, Frontal Sinus Dilators
Legra de succión, Dilatadores para el seno
Rugine-raspatoire à succion, Dilatateurs pour le sinus frontal
Raspatorio con aspiratore, Dilatatori per il seno frontale

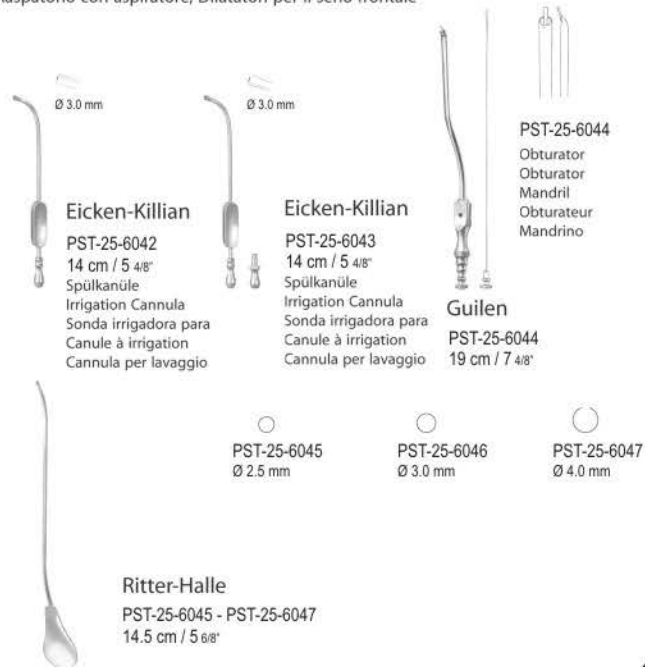

Ringmesser

Adenoid Curettes
Cuchillos para adenoides
Couteaux à végétations adénoïdales
Coltelli per vegetazioni adenoidee

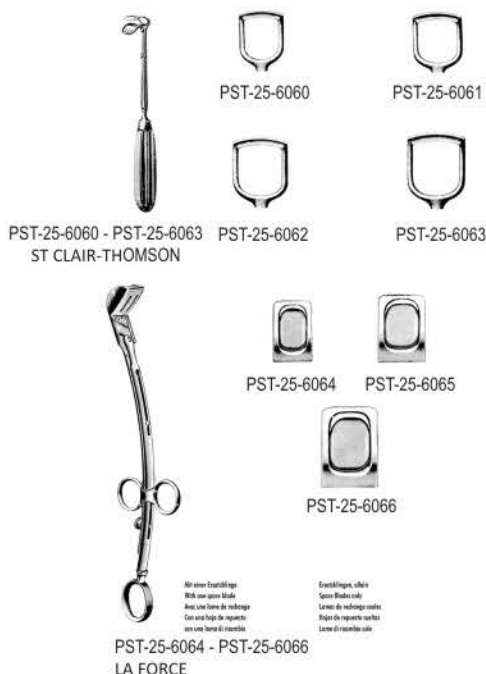
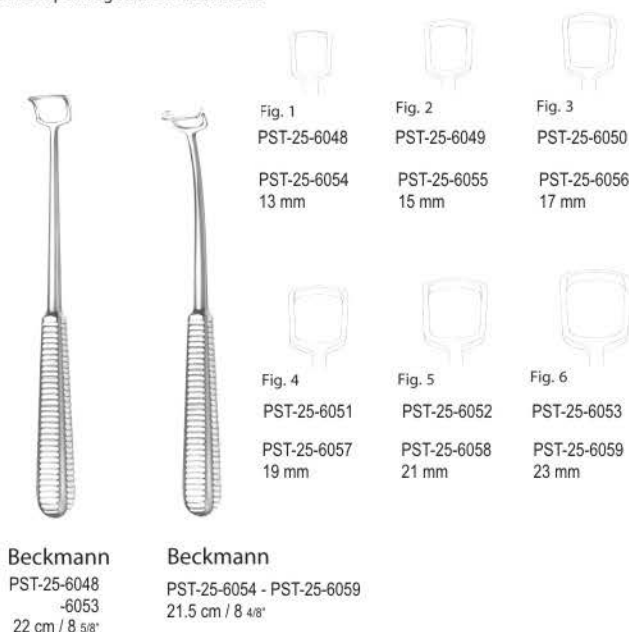

Mund-, Kiefer-
Gesichtschirurgie

Oral Maxillo-Facial Surgery
Cirugía oral y maxilofacial
Chirurgie buccale et maxillo-faciale 26
Chirurgie buccale e maxillo-faciale



Quality Instruments

Elevatoren, Transplantatstopfer, Fräser

Elevators, Graft Packers, Burrs
Elevadores, Atacadores de trasplantes, Fresas
Élévateurs, Poussoirs pour transplantation, Mèches
Elevatori, Turatori per innesti, Alesatori

Terry
PST-26-6101
17 cm / 6 5/8"

5.0 mm
8.0 mm

Terry
PST-26-6102
11.5 cm / 4 1/8"

Terry
PST-26-6103
13 cm / 5 1/8"

Terry
PST-26-6104
18 cm / 7 1/8"

3.0 mm
7.0 mm

Lindemann
PST-26-6105 - 6108

zur vertikalen Spaltung im bukkalen Bereich des Unterkiefers
for vertical cuts in the buccal aspect of the mandible
para cortes verticales en el aspecto bucal de la mandibula
pour séparation verticale dans la zone buccale mandibulaire dans la mâchoire inférieure
per osteomie verticali nella zona buccale della mandibula

PST-26-6105
4.5 cm / 1 6/8"
10 mm

PST-26-6106
6.5 cm / 2 4/8"
22 mm

PST-26-6107
8 cm / 3 1/8"
35 mm

PST-26-6108
8 cm / 3 1/8"
10 mm

Fingerschutz, Mundkeile

Finger Protector, Mouth Gags
Dedal, Abre bocas
Doigtiers, Baillons
Protettore per dita, Apribocca

Adams
PST-26-6109

Serviettenhalter
Napkin Holder
Porta-servilleta
Porte-serviettes
Porta-salviette

Langenbeck
PST-26-6110
Ø 26 / 20 mm

Maunder
PST-26-6111
9.5 cm / 3 5/8"

Holz
wood
madera
bois
legno

Pitha
PST-26-6112

Silikon
silicone
silicona
silicone
silicona
28 x 30 mm

Mundkeile, Mundsperrerr

Mouth Gags, Mouth Gags
Abre bocas, Abre bocas
Baillons, Ouvre-bouche
Apribocca, Apribocca

Mckesson
kunststoffbeschichteter Metallrahmen
ohne Kette
plastic coated metal frame
without chain
cuadro metálico, cubierto de plástico
sin cadena
cadre métal avec revêtement synthétique
sans chaîne
telaio metallico, ricoperto in plastica
senza catena

PST-26-6117
a groß, für Zahnlose
a large, for edentulous
muy grande, para desdentados
très grand, pour édentés
molto grande, per sdentati

PST-26-6118
normal, für Erwachsene
regular, for adults
regular, para adultos
regulier, pour adultes
regolare, per adulti

PST-26-6119
klein, für Kleinkinder
small, for babies
pequeño, para bebés
petit, pour bébés
piccolo, per neonati

PST-26-6120
Kette, allein
Chain, only
Cadena, suelto
Chaîne, seul
Catena, solo

Heister
PST-26-6113
13 cm / 5 1/8"

Obwegeser
PST-26-6114
11 cm / 4 3/8"

Spreizweite
spreading
extensión
écartement
apertura
47 mm

Mundsperrerr

Mouth Gags
Abre bocas
Ouvre-bouche
Apribocca

Molt
PST-26-6121
11 cm / 4 3/8"

Molt
PST-26-6122
13 cm / 5 1/8"

Denhart
PST-26-6124
13 cm / 5 1/8"

Roser-König
PST-26-6125 - PST-26-6126

Backen
jaws
bocas
mors
branche
16 mm

PST-26-6123
Ersatzgummi
Spare Rubber
Goma de repuesto
Caoutchouc de remplacement
Gomma di ricambio

PST-26-6125
16 cm / 6 2/8"

PST-26-6126
19 cm / 7 4/8"

Mund-,Kiefer-
Gesichtschirurgie

Oral Maxillo-Facial Surgery
Cirugia oral y maxilofacial
Chirurgie buccale et maxillo-faciale 26
Chirurgie buccale e maxillo-faciale



Quality Instruments

Mundsperrer

Mouth Gags
Abrebocas
Ouvre-bouche
Apribocca



PST-26-6129
Gaumenplatte
Palate Plate
Plaquita paldia
Plaque platine
Placca per palato

Kilner-Doughty

PST-26-6127

komplett mit Rahmen, 3 Zungenspatel und 1 Gaumenplatte
complete, with frame, 3 tongue depressors, 2 toothplates and 1 palate plate

completo con bastidor, 3 bajalenguas, 2 plaquitas de dientes y 1 plaquita paldia

complet avec cadre, 3 abaisse-langue, 2 plaques pour dents e 1 plaque palatine

completo, con telaio, 3 abassalingua, 2 placche per denti e 1 placca per palato

Kilner-Doughty

PST-26-6128
14.5 cm / 5 8/16"

Mundsperrer-Rahmen
Frame for Mouth Gag
Bastidor para abrebooca
Cadre pour ouvre-bouche
Telaio per apribocca

Kilner-Doughty

PST-26-6130 - PST-26-6132

Zungendrucker

Tongue Depressor

Bajalengua

Abaisse-langue

Abassalingua

gefenestertes Blatt für Absaugung

fenestrated blade for suction

hoja fenestrada para succión

lame fenêtrée pour aspiration

lama con finestra per aspirazione



Fig. 1

PST-26-6130
68 x 30 mm

Fig. 2

PST-26-6131
77 x 34 mm

Fig. 3

PST-26-6132
82 x 39 mm

Mundsperrer

Mouth Gags
Abrebocas
Ouvre-bouche
Apribocca



Neukam

PST-26-6133

komplett mit Rahmen und 3 Zungenspateln
complete, with frame and 3 tongue depressors
completo con bastidor y 3 bajalenguas
complet avec cadre et 3 abaisse-langue
completo, con telaio e 3 abassalingua

Neukam

PST-26-6134

Mundsperrer-Rahmen, allein
Frame for Mouth Gag, only
Bastidor para abrebooca, suelto
Cadre pour ouvre-bouche, seul
Telaio per apribocca, solo

PST-26-6135
PST-26-6137

Zungendrucker

Tongue Depressor

Bajalengua

Abaisse-langue

Abassalingua

gefenestertes Blatt für Absaugung

fenestrated blade for suction

hoja fenestrada para succión

lame fenêtrée pour aspiration

lama con finestra per aspirazione



Fig. 1

PST-26-6135

Fig. 2

PST-26-6136

Fig. 3

PST-26-6137

Mundsperrer

Mouth Gags
Abrebocas
Ouvre-bouche
Apribocca



Davis-Boyle

PST-26-6138

komplett, bestehend aus Rahmen und fünf Zungenspateln Fig. 1 - 5

complete, consisting of frame and 5 tongue depressors no. 1 - 5

completo, consiste de bastidor y 5 bajalenguas no. 1 - 5

complet, se composant de cadre e 5 abaisse-langue no. 1 - 5

completo, composto di telaio e 5 abassalingua no. 1 - 5

PST-26-6139

Mundsperrer-Rahmen
Frame for Mouth Gag
Bastidor para abrebooca
Cadre pour ouvre-bouche
Telaio per apribocca



Fig. 2

PST-26-6141
95 x 27 mm

Fig. 3

PST-26-6142
80 x 27 mm

Fig. 4

PST-26-6143
65 x 26 mm

Fig. 5

PST-26-6144
30 x 20 mm

PST-26-6140 - PST-26-6144

mit fester Absaugung

with fixed suction tube

con tubo de succión fijo

avec tube d'aspiration fixée

con tubo di aspirazione fisso

Fig. 1

PST-26-6140
110 x 28 mm

ohne Absaugung
without suction tube
sin tubo de succión fijo
sans tube d'aspiration fixée
senza tubo di aspirazione fisso

Mundsperrer

Mouth Gags
Abrebocas
Ouvre-bouche
Apribocca



Mclvor

PST-26-6145

komplett, mit 3 Zungenspateln
complete, with 3 tongue depressors
completo, con 3 bajalenguas
complet, avec 3 abaisse-langue
completo, con 3 abassalingua

Mclvor

PST-26-6146

Mundsperrer-Rahmen
Frame for Mouth Gag
Bastidor para abrebooca
Cadre pour ouvre-bouche
Telaio per apribocca

Mclvor

PST-26-6147 - PST-26-6149

Zungenspatel

Tongue Depressor

Bajalengua

Abaisse-langue

Abassalingua



Fig. 1

PST-26-6147
100 x 25 mm

Fig. 2

PST-26-6148
85 x 25 mm

Fig. 3

PST-26-6149
75 x 25 mm

Mund-, Kiefer-
Gesichtschirurgie

Oral Maxillo-Facial Surgery
Cirugía oral y maxilofacial
Chirurgie buccale et maxillo-faciale 26
Chirurgie buccale e maxillo-faciale



Quality Instruments

Mundsperrer

Mouth Gags
Abrebocas
Ouvre-bouche
Apribocca

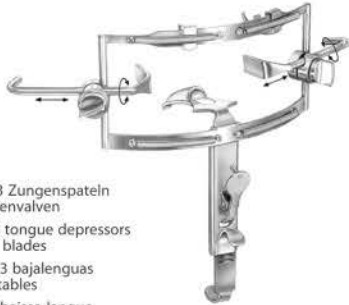

Dingmann
PST-26-6150

komplett mit Rahmen, 3 Zungenspateln
und 2 beweglichen Seitenvälven
complete, with frame, 3 tongue depressors
and 2 adjustable lateral blades
completo con bastidor, 3 bajalenguas
y 2 valvas laterales ajustables
complet avec cadre, 3 abaisse-langue
et 2 valves latérales réglables
completo, con telaio, 3 abassalingua
e 2 valve laterali movibili

Dingmann
PST-26-6151 - PST-26-6153

Zungenspatel
Tongue Depressor
Bajalengua
Abaisse-langue
Abassalingua



Fig. 1 PST-26-6151 62 x 26 mm
Fig. 2 PST-26-6152 65 x 30 mm
Fig. 3 PST-26-6153 78 x 32 mm

Mundsperrer, Lippen- und Wangenhalter

Mouth Gags, Lip and Cheek Retractors
Abrebocas, Separadores para labios y mejillas
Ouvre-bouche, Ecarteurs des lèvres et joues
Apribocca, Separatori per labbra e guancia



Jennings
PST-26-6154 - PST-26-6157

PST-26-6154 10.5 cm / 4 1/8"
PST-26-6155 12.5 cm / 4 7/8"
PST-26-6156 14.5 cm / 5 6/8"
PST-26-6157 16.5 cm / 6 4/8"



Oringer

PST-26-6158
9.5 cm / 3 6/8"
selbsthaltend, für Kinder
self retaining, for children
autoestático, para niños
autostatique, pour enfants
autostatico, per bambini

Fig. 1 PST-26-6159 10 cm / 3 7/8"
Fig. 2 PST-26-6160 10.5 cm / 4 1/8"
Fig. 3 PST-26-6161 11 cm / 4 3/8"

PST-26-6162
selbsthaltend Satz mit Fig. 1-3
self retaining set with no. 1-3
autoestático juego de no. 1-3
autostatique jeu de no. 1-3
autostatico set con no. 1-3



Lippen- und Wangenhalter

Lip and Cheek Retractors
Separadores para labios y mejillas
Ecarteurs des lèvres et joues
Separatori per labbra e guancia

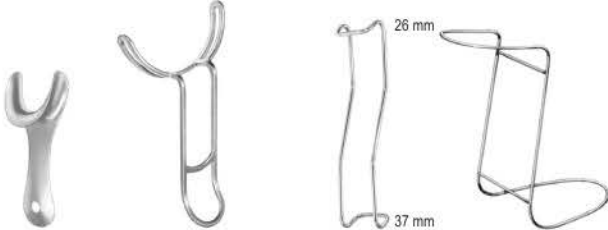

Martin-Simplex
PST-26-6163
10.5 cm / 4 1/8"

PST-26-6164
14 cm / 5 4/8"
Vestibulumhaken
Vestibulum Retractor
Separador para vestibul
Ecarteur pour vestibul
Separatore per vestibul

Sternberg
PST-26-6165
14 cm / 5 4/8"

Obwegeser
PST-26-6166
12 cm / 4 6/8"



Bishop
PST-26-6167
13.5 cm / 5 3/8"

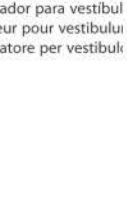

Cawood-Minnesota
PST-26-6168
15.5 cm / 6 1/8"



Cawood-Minnesota
PST-26-6169
14 cm / 5 6/8"

Zungendrucker

Tongue Depressors
Abajalenguas
Abaisse-langue
Abassalingua



Hartmann
PST-26-6170
15 cm / 5 7/8"

Tobold
PST-26-6171
15 cm / 5 7/8"

Tobold
PST-26-6172
16 cm / 6 2/8"

Wieder
PST-26-6173 - PST-26-6174

80 x 25 mm
PST-26-6173
43 mm

PST-26-6174
14 cm / 5 4/8"
36 mm



Mund-,Kiefer-
Gesichtschirurgie

Oral Maxillo-Facial Surgery
Cirugía oral y maxilofacial
Chirurgie buccale et maxillo-faciale 26
Chirurgie buccale e maxillo-faciale



Quality Instruments

Zungenspatel

Tongue Spatulas
Espátulas linguales
Abaisse-langue
Spatole per lingua



PST-26-6175
15 cm / 5 7/8"
Holz
wood
madera
bois
legno

Packung mit 100 Stück
package of 100 pieces
paquete con 100 piezas
paquet avec 100 pièces
confezione di 100 pezzi



PST-26-6176
15 cm / 5 7/8"
Kunststoff
plastic
plástico
matière plastique
plastica

Packung mit 100 Stück
package of 100 pieces
paquete con 100 piezas
paquet avec 100 pièces
confezione di 100 pezzi



Martin

PST-26-6177
18.5 cm / 7 2/8"

15 mm



Doyen

PST-26-6178 - PST-26-6179



PST-26-6178
13 cm / 5 1/8"
23 x 30 mm



PST-26-6179
16 cm / 6 2/8"
30 x 33 mm



Brünings

PST-26-6180
19 cm / 7 4/8"

19 mm

Zungenzangen

Tongue Holding Forceps
Pinzas tira-lengua
Pincés tire-langue
Pinze per lingua



Young

PST-26-6183

Gummipolster
Rubber Inserts
Bocas de goma
Mors en caoutchouc
Cuscino di gomma

Paar
pair
par
paire
paio



Collin

PST-26-6181
17 cm / 6 6/8"



Young

PST-26-6182
15 cm / 5 7/8"

Extraorale Retraktoren

Extra Oral Retractors
Separadores extra orales
Rétracteurs extra-oraux
Separatori extraorali

9,5/16 mm



PST-26-6184
22 cm / 8 5/8"

konkav, stark aufgebogen
concave, fully bent tip
concáva, fuertemente curva
concava, fortemente curva



Eckelt

PST-26-6185
21 cm / 8 2/8"

Extraorale Retraktoren

Extra Oral Retractors
Separadores extra orales
Rétracteurs extra-oraux
Separatori extraorali

9,5/16 mm



PST-26-6186
25 cm / 9 7/8"

konkav, stark aufgebogen
concave, fully bent tip
concáva, fuertemente curva
concava, fortemente curva

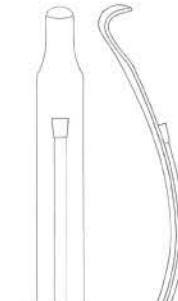

Eckelt

PST-26-6187
25 cm / 9 7/8"

konkav, stark aufgebogen
concave, fully bent tip
concáva, fuertemente curva
concava, fortemente curva

Mund-,Kiefer-
Gesichtschirurgie

Oral Maxillo-Facial Surgery
Cirugía oral y maxilofacial
Chirurgie buccale et maxillo-faciale 26
Chirurgie buccale e maxillo-faciale



Quality Instruments

Intraorale Retraktoren

Intra Oral Retractors
Separadores intra orales
Rétracteurs intra-oraux
Separatori intraorali



PST-26-6188
23 cm / 9"
für LeFort Osteotomie
for LeFort osteotomies
para osteotomías según LeFort
pour ostéotomie selon LeFort
per osteotomie sec. LeFort
25,5 mm



PST-26-6189
26 cm / 10 2/8"
für LeFort Osteotomie
for LeFort osteotomies
para osteotomías según LeFort
pour ostéotomie selon LeFort
per osteotomie sec. LeFort
25,5 mm

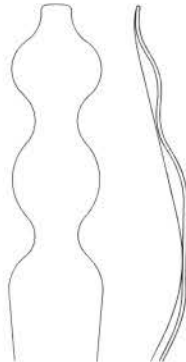

Intraorale Retraktoren

Intra Oral Retractors
Separadores intra orales
Rétracteurs intra-oraux
Separatori intraorali



PST-26-6190
21 cm / 8 2/8"
rechts
right
derecho
droit
destra



PST-26-6191
21 cm / 8 2/8"
links
left
izquierdo
gauche
sinistra



PST-26-6192
24.5 cm / 9 5/8"
rechts
right
derecho
droit
destra



PST-26-6193
24.5 cm / 9 5/8"
links
left
izquierdo
gauche
sinistra

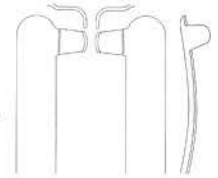

Intraorale Retraktoren

Intra Oral Retractors
Separadores intra orales
Rétracteurs intra-oraux
Separatori intraorali

12.5 / 27 mm



PST-26-6194
25 cm / 9 7/8"
L&M, für vertikale Osteotomie
L&M for vertical osteotomy
L&M, para osteotomía vertical
L&M, pour ostéotomie verticale
L&M, per osteotomia verticale

12.5 / 27 mm



PST-26-6195
28 cm / 11"
L&M, für vertikale Osteotomie
L&M for vertical osteotomy
L&M, para osteotomía vertical
L&M, pour ostéotomie verticale
L&M, per osteotomia verticale

14.5 mm



Shea
PST-26-6196
23.5 cm / 9 2/8"
Mehrzweck-Retraktor
Multi purpose Retractor
Separador de aplicaciones varias
Rétracteur pour applications
Separatore multiuso

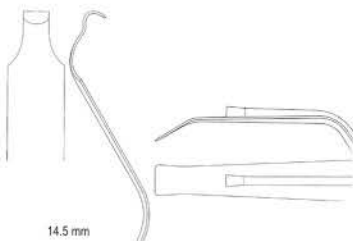

Weichteilhaken

Soft Tissue Retractors
Separadores para partes blandas
Crochets pour parties molles
Separatori per tessuti molli

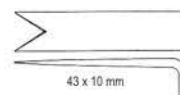

43 x 10 mm



Obwegeser
PST-26-6197
22 cm / 8 5/8"

Spina nasalis-Haken
Nasal Spine Retractor
Separador para spina nasalis
Ecarteur pour spina nasalis
Separatore per spina nasale



Obwegeser
PST-26-6198 - PST-26-6200



PST-26-6198
22.5 cm / 8 7/8"
43 x 11 mm



PST-26-6199
23 cm / 9"
57 x 11 mm



PST-26-6200
23 cm / 9"
80 x 16 mm



Mund-,Kiefer-
Gesichtschirurgie

Oral Maxillo-Facial Surgery
Cirugía oral y maxilofacial
Chirurgie buccale et maxillo-faciale 26
Chirurgie buccale e maxillo-faciale



Quality Instruments

Ramushaken, Kinnhalter, Progenierinnen

Ramus Retractors, Chin Retractor, Channel Retractors
Separadores para el ramo, Gancho de mentón, Separadores mandibulares
Ecarteurs pour ramus, Fixe-menton, Ecarteurs mandibulaires
Separatore per ramo, Guancio per mento, Separatori mandibulari



72 x 10 mm



Obwegeser
PST-26-6201
22 cm / 8 5/8"



Obwegeser
PST-26-6202
16.5 cm / 6 4/8"



PST-26-6203
16 cm / 6 2/8"
8 mm

PST-26-6204
16 cm / 6 2/8"
10 mm

Progeniehaken

Progeny Retractor
Separadores para progenismo
Crochets de progenie
Separatori per progenismo

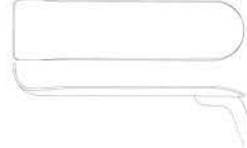

Schuchardt
PST-26-6205
18 cm / 7 1/8"



Metz
PST-26-6206
19.5 cm / 7 5/8"

Wundhaken

Retractors
Separadores
Ecarteurs
Divaricatori



Koberg
PST-26-6207
15 x 7 mm



Koberg, mod.
PST-26-6208
20 x 7 mm



PST-26-6207 - PST-26-6208
18 cm / 7 1/8"

Progeniehaken

Progeny Retractor
Separadores para progenismo
Crochets de progenie
Separatori per progenismo

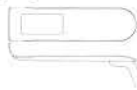

Schuchardt-Lauer
PST-26-6209
15 cm / 5 7/8"



Metz-Lauer
PST-26-6210
15 cm / 5 7/8"

Raspatorien

Periosteal Elevators
Legras
Rugines-raspatoires
Elevatori per periosteo



3 mm

PST-26-6211
18 cm / 7 1/8"



3.5 mm

PST-26-6212
18 cm / 7 1/8"

Progeniehaken

Progeny Retractor
Separadores para progenismo
Crochets de progenie
Separatori per progenismo



Schuchardt-Lauer
PST-26-6213
15 cm / 5 7/8"



Metz-Lauer
PST-26-6214
15 cm / 5 7/8"

Mund-, Kiefer-
Gesichtschirurgie

Oral Maxillo-Facial Surgery
Cirugía oral y maxilofacial
Chirurgie buccale et maxillo-faciale 26
Chirurgie buccale e maxillo-faciale



Quality Instruments

Progeniehaken

Progeny Retractor
Separadores para progenismo
Crochets de progenie
Separatori per progenismo

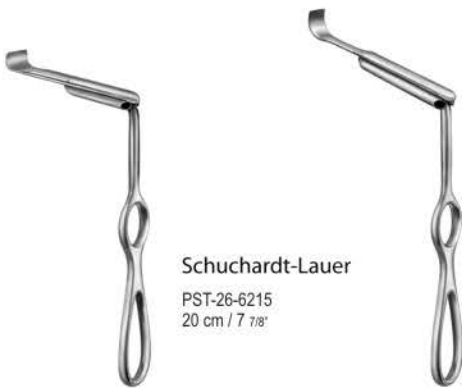
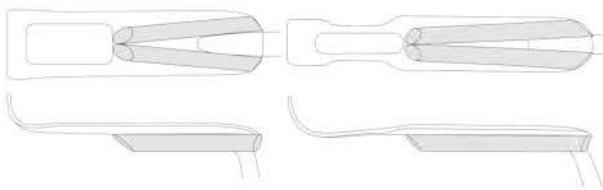

Schuchardt-Lauer

PST-26-6215
20 cm / 7 7/8"

Metz-Lauer

PST-26-6216
20 cm / 7 7/8"



Raspatorien

Periosteal Elevators
Periostótomos
Rugines-raspatoires
Periostotomi

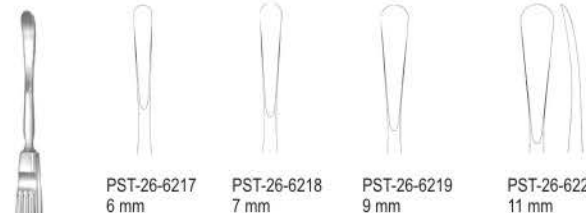

PST-26-6217
6 mm

PST-26-6218
7 mm

PST-26-6219
9 mm

PST-26-6220
11 mm

Obwegeser

PST-26-6217 - PST-26-6220
17.5 cm / 6 7/8"

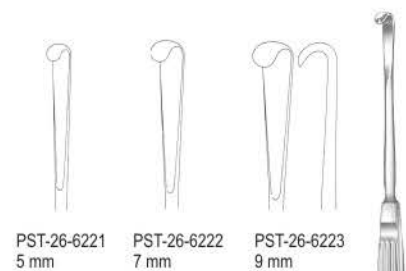

PST-26-6221
5 mm

PST-26-6222
7 mm

PST-26-6223
9 mm

Obwegeser

PST-26-6221 - PST-26-6223
20 cm / 7 7/8"



Raspatorien

Periosteal Elevators
Periostótomos
Rugines-raspatoires
Periostotomi

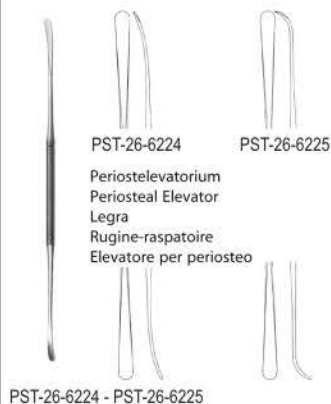

PST-26-6224

PST-26-6225

Periostelevatorium
Periosteal Elevator
Legra
Rugine-raspatoire
Elevatore per perioste

PST-26-6224 - PST-26-6225

Fig. 11

PST-26-6226

Fig. 12

PST-26-6227

Gelenkpositionierer
Condylar Repositioning Instrument
Instrumento para reposicion condylar
Repositionneur pour articul. mahoire
Strumento di riposizionamento condilare

Obwegeser

PST-26-6226 - PST-26-6229
17.5 cm / 6 7/8"

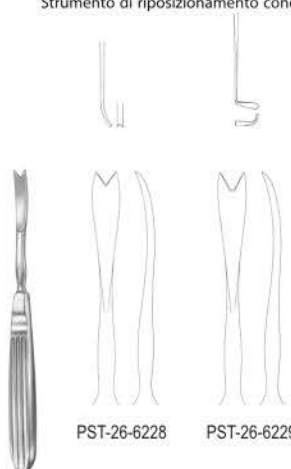

PST-26-6228

PST-26-6229



Elevatorien, Osteotome, Drahtpositionierer, Drahtbogen

Elevators, Osteotomes, Wire Pushers
Elevadores, Osteótomos, Empujadores de alambres
Élévateurs, Ostéotomes, Outil de positionnement
Elevatori, Osteotomi, Posizionatori per filo

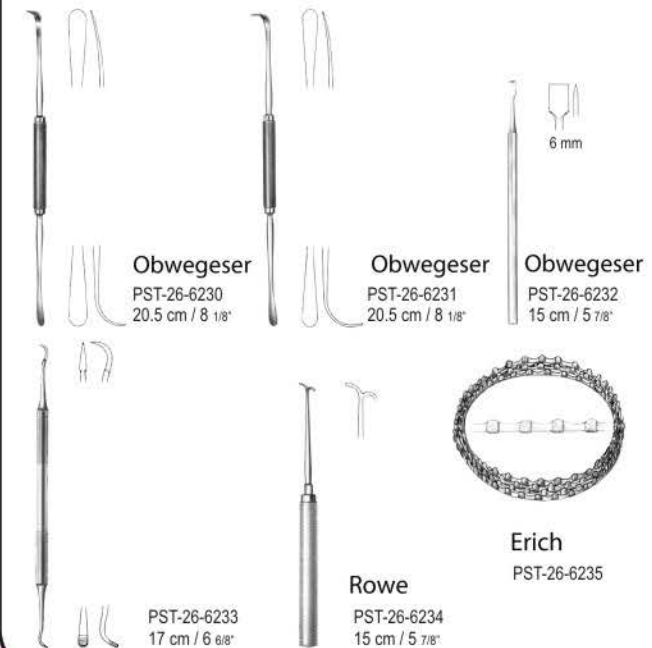

Obwegeser

PST-26-6230
20.5 cm / 8 1/8"

Obwegeser

PST-26-6231
20.5 cm / 8 1/8"

Obwegeser

PST-26-6232
15 cm / 5 7/8"

PST-26-6233
17 cm / 6 6/8"

Rowe

PST-26-6234
15 cm / 5 7/8"

Erich

PST-26-6235



Mund-,Kiefer-
Gesichtschirurgie

Oral Maxillo-Facial Surgery
Cirugia oral y maxilofacial
Chirurgie buccale et maxillo-faciale 26
Chirurgie buccale e maxillo-faciale



Quality Instruments

Orbitahaken, Orbitalrand-Retraktor

Orbital Hook, Orbital Rim Retractor
Gancho orbital, Separador reb. Orbital
Crochet orbital, Ecarteur orbital
Divercatore orbitale



PST-26-6236
links
left
izquierdo
gauche
sinistra



PST-26-6237
rechts
right
derecho
droit
destra

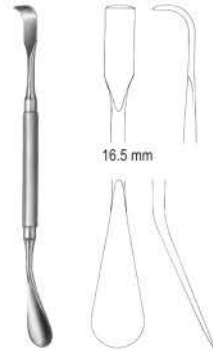

Donovan
PST-26-6239
19.5 cm / 7 5/8"

Rowe
PST-26-6236 - PST-26-6237
19 cm / 7 4/8"



PST-26-6238
20 cm / 7 7/8"

Repositionszangen

Disimpaction Forceps
Pinzas para reposición
Pincers de reposition
Pinze per riduzione



PST-26-6240 L
PST-26-6241 R
21.5 cm / 8 4/8"



PST-26-6242 L
PST-26-6243 R
24 cm / 9 4/8"



PST-26-6244 L
PST-26-6245 R
24.5 cm / 9 5/8"

Rowe
L
links
left
izquierdo
gauche
sinistra



Rowe
R
rechts
right
derecho
droit
destra



Zygoma-Elevatorien

Zygoma Elevators
Elevadores cigomáticos
Élévateurs zygomatiques
Elevatori per zigomo



PST-26-6246
links
left
izquierdo
gauche
sinistra



PST-26-6247
rechts
right
derecho
droit
destra



Tessier
PST-26-6246 - PST-26-6247

Mobilisierhaken
Maxillary Mobilizer
Gancho para movilización
Mobilisateur
Gancio per mobilizzare



PST-26-6248
20 cm / 7 7/8"



Dingmann
PST-26-6249
21.5 cm / 8 4/8"

Spitze
tip
punta
pointe
punta
Ø 5,0 mm

Wundhaken, Knochenhalteanzgen

Retractors, Bone Holding Forceps
Separadores, Pinzas para huesos
Ecarteurs, Pincers pour os
Divaricatori, Pinze per ossa



Dingmann-Wilk
PST-26-6250
20 cm / 7 7/8"



Eckelt
PST-26-6251
20 cm / 7 7/8"
Plattenzuginstrument
Plate-pulling Instrument
Pinaz agarre para placas
Crochet our maintenir plaque
Strumento per
riposizionamento placche



Jeter-Van Sickers
PST-26-6252 - PST-26-6253

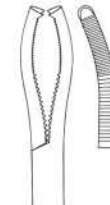

PST-26-6252
19 cm / 7 4/8"

leichtes Modell, für sagittalen Split
light pattern, for sagittal split procedure
modelo ligero, para uso en el sagittal split
modèle léger, pour fente sagittale
modello leggero, per uso dell'osteotomia sagittale

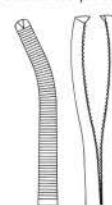

PST-26-6253
18 cm / 7 1/8"

Mund-,Kiefer-
Gesichtschirurgie

Oral Maxillo-Facial Surgery
Cirugia oral y maxilofacial
Chirurgie buccale et maxillo-faciale 26
Chirurgie buccale e maxillo-faciale



Quality Instruments

Knochenhaltezangen

Bone Holding Forceps
Pinzas para huesos
Pincers pour os
Pinze per ossa



Keen

PST-26-6254 - PST-26-6255
17.5 cm / 6 7/8"



PST-26-6254
links
left
izquierdo
gauche
sinistra

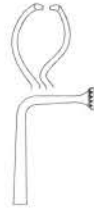

PST-26-6255
rechts
right
derecho
droit
destra



Steinhäuser

PST-26-6256
13.5 cm / 5 3/8"



Steinhäuser

PST-26-6257
12.5 cm / 4 7/8"

Knochenhaltezangen

Bone Holding Forceps
Pinzas para huesos
Pincers pour os
Pinze per ossa



Wolford

PST-26-6258
25 cm / 9 7/8"



Salyer

PST-26-6259
16.5 cm / 6 4/8"



Instrumente für TMJ

Instruments for TMJ
Instrumentos para TMJ
Instruments pour TMJ
Instruments per TMJ



PST-26-6260
links
left
izquierdo
gauche
sinistra

PST-26-6261
rechts
right
derecho
droit
destra



Dolwick

PST-26-6262
12.5 cm / 4 7/8"

TMJ-Disc-Klemme
TMJ Disc Forceps
Pinza para ATM
Pince machoire
Pinza snodo mascella



Dolwick

PST-26-6263
13.5 cm / 5 3/8"

TMJ-Disc-Schere
TMJ Disc Scissors
Tijersa para ATM
Ciseaux machoire
Forbice snodo mascella

Dolwick

PST-26-6260 - PST-26-6261
16 cm / 6 2/8"

TMJ-Spreizer
TMJ-Spreader
Separador para ATM
Ecarteur pour TMJ
Divaricatore per TMJ



Dolwick

PST-26-6264
14.5 cm / 5 6/8"

TMJ-Resektionsmesser
Resection Knife for TMJ
Cuchillo para resección para ATM
Couteaux à résection pour TMJ
Coltello per resezione per TMJ



Dolwick

PST-26-6265
17 cm / 6 6/8"

TMJ-Elevatorium
TMJ-Elevator
Elevador para ATM
Elevateur pour TMJ
Elevatore per TMJ

Dolwick

PST-26-6266
14.5 cm / 5 6/8"

TMJ-Kondylenhaken
TMJ Condyle Hook
Gancho para condilos ATM
Crochet condyle machoire
Divaricatore per Condilo



Instrumente für TMJ

Instruments for TMJ
Instrumentos para TMJ
Instruments pour TMJ
Instruments per TMJ



Dolwick

PST-26-6267 - PST-26-6269

TMJ-Raspel
TMJ-Rasp
Escofina para ATM
Râpe pour TMJ
Raspa per TMJ

PST-26-6267
15 cm / 5 7/8"

PST-26-6268
15 cm / 5 7/8"

PST-26-6269
17.5 cm / 6 7/8"

Dolwick

PST-26-6270
22 cm / 8 5/8"

Ligaturklemme
Ligature Forceps
Pinza para ligaduras
Pince à ligatures
Pinza per legature



Mund-,Kiefer-
Gesichtschirurgie

Oral Maxillo-Facial Surgery
Cirugía oral y maxilofacial
Chirurgie buccale et maxillo-faciale 26
Chirurgia buccale e maxillo-faciale



Quality Instruments

Instrumente für TMJ

Instruments for TMJ
Instrumentos para TMJ
Instruments pour TMJ
Instruments per TMJ



Dolwick
PST-26-6271
16 cm / 6 2/8"

TMJ-Klemme
TMJ-Forceps
Pinza para ATM
Pinze pour TMJ
Pinza per TMJ



Dolwick
PST-26-6272
16 cm / 6 2/8"

TMJ-Klemme
TMJ-Forceps
Pinza para ATM
Pinze pour TMJ
Pinza per TMJ



Champer
PST-26-6273
16 cm / 6 2/8"

TMJ-Spreizer
TMJ-Spreader
Separador para ATM
Ecarteur pour TMJ
Divaricatore per TMJ

Osteotome

Osteotomes
Osteótomos
Ostéotomes
Osteotomi

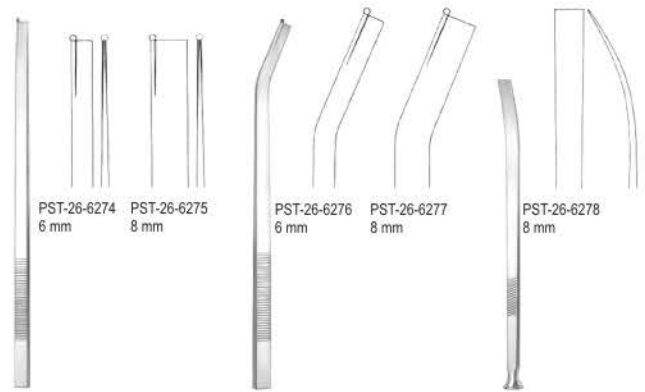

PST-26-6274 6 mm
PST-26-6275 8 mm

PST-26-6276 6 mm
PST-26-6277 8 mm

PST-26-6278 8 mm

Bauer

PST-26-6274 - PST-26-6275
20.5 cm / 8 1/8"

Bauer

PST-26-6276 - PST-26-6277
20.5 cm / 8 1/8"

Epker-Bauer

PST-26-6278
17.5 cm / 6 7/8"

Osteotome

Osteotomes
Osteótomos
Ostéotomes
Osteotomi

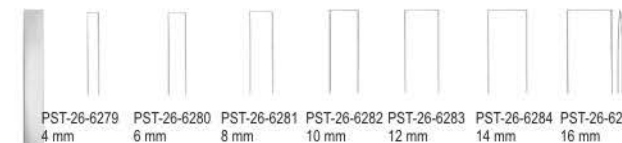

PST-26-6279 4 mm
PST-26-6280 6 mm
PST-26-6281 8 mm
PST-26-6282 10 mm
PST-26-6283 12 mm
PST-26-6284 14 mm
PST-26-6285 16 mm

Dautrey-Munro

PST-26-6279 - PST-26-6285
16 cm / 6 2/8"

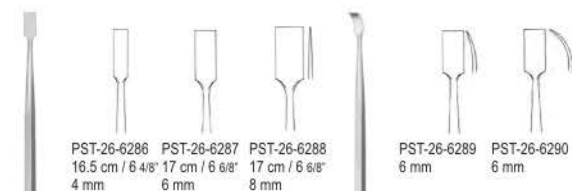

PST-26-6286 16.5 cm / 6 4/8" 4 mm
PST-26-6287 17 cm / 6 6/8" 6 mm
PST-26-6288 17 cm / 6 6/8" 8 mm
PST-26-6289 6 mm
PST-26-6290 6 mm

Dunn-Dautrey

PST-26-6286 - PST-26-6288

Dunn-Dautrey

PST-26-6289 - PST-26-6290
17 cm / 6 6/8"

Osteotome

Osteotomes
Osteótomos
Ostéotomes
Osteotomi

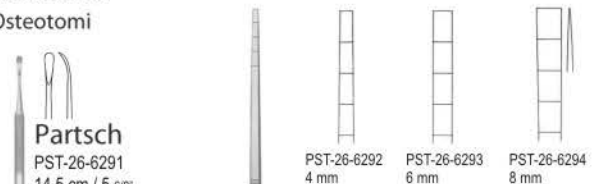

Parsch

PST-26-6291
14.5 cm / 5 6/8"

PST-26-6292 4 mm
PST-26-6293 6 mm
PST-26-6294 8 mm

Epker

PST-26-6292 - PST-26-6294
18 cm / 7 1/8"

Raspatorium
Periosteal Elevator
Periostótomo
Rugines-raspatoire
Periostotomo

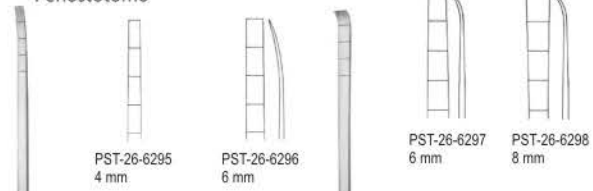

PST-26-6295 4 mm
PST-26-6296 6 mm

PST-26-6297 6 mm
PST-26-6298 8 mm

Epker

PST-26-6295 - PST-26-6296
18 cm / 7 1/8"

Epker

PST-26-6297 - PST-26-6298
18 cm / 7 1/8"

Mund-,Kiefer-
Gesichtschirurgie

Oral Maxillo-Facial Surgery
Cirugia oral y maxilofacial
Chirurgie buccale et maxillo-faciale 26
Chirurgie buccale e maxillo-faciale



Quality Instruments

Ramushaken

Ramus Retractors
Separadores para el ramo
Ecarteurs pour ramus
Divaricatori per il ramo



Hargis

PST-26-6299
16 cm / 6 2/8"

Lippen- und Wangenhalter
Lip and Cheek Retractor
Separador para labios y mejillas
Ecarteur pour lèvres et joues
Separatore per labbra e guancia



Hargis

PST-26-6300 - PST-26-6301
19.5 cm / 7 5/8"

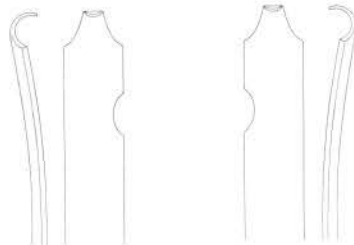

PST-26-6300

links
left
izquierdo
gauche
sinistra

PST-26-6301

rechts
right
derecho
droit
destra



Unterkieferkörperhaken, Vorderrandstripper

Mandibular Body Retractor, Anterior Border Stripper
Separador para el cuerpo mandibular, Separador para el borde anterior
Ecarteur pour corps mandibulaire, Ecarteur pour le bord antérieur
Separatore per il corpo mandibulare, Separatore per il bordo anteriore



Hargis

PST-26-6302
17.5 cm / 6 7/8"

Hargis

PST-26-6303
18.5 cm / 7 2/8"



Raspatorien

Periosteal Elevators
Legras
Rugine-raspatoires
Elevatori per periosteo



PST-26-6304
23.5 cm / 9 2/8"

rechts
right
derecho
droit
destra

PST-26-6305
23 cm / 9"

rechts
right
derecho
droit
destra

PST-26-6306
23.5 cm / 9 2/8"

links
left
izquierdo
gauche
sinistra

PST-26-6307
23 cm / 9"

links
left
izquierdo
gauche
sinistra

Hargis

PST-26-6304 - PST-26-6307



Piriformis-Haken, Pterygoideus-Osteotom, Knochenfassklemme

Periform Rim Retractor, Pterygoid Osteotome, Bone Holding Forceps
Gancho piriforme, Osteótomo pterigoideo, Pinza para coger huesos
Crochet pour la fosse piriforme, Ostéotome ptérygoïde, Pince pour saisir os
Divaricatore per piriforme, Osteotomo per pterigoideo, Afferratoio per ossa



Hargis

PST-26-6308
18.5 cm / 7 2/8"

Hargis

PST-26-6309
22 cm / 8 5/8"

Hargis

PST-26-6310
19 cm / 7 4/8"
mit Kette
with chain
con cadena
avec chaîne
con catena

PST-26-6311
55 cm / 21 5/8"
Kette, allein
Chain, only
Cadena, suelto
Chaîne, seul
Catena, solo



Mund-,Kiefer-
Gesichtschirurgie

Oral Maxillo-Facial Surgery
Cirugía oral y maxilofacial
Chirurgie buccale et maxillo-faciale 26
Chirurgie buccale e maxillo-faciale



Quality Instruments

Zygoma-Wundhaken
Zygomatic Retractor
Separador cigomático
Ecarteur cygomatique
Divaricatore per zigomo

PST-26-6312
rechts
right
derecho
droit
destra
50 x 20 mm

PST-26-6313
links
left
izquierdo
gauche
sinistra
50 x 20 mm

Steinhäuser
PST-26-6312 - PST-26-6313
25 cm / 9 7/8"

Raspatorien, Osteotome
Raspatories, Osteotomes
Legras, Osteótomos
Rugine-raspatoires, Ostéotomes
Elevatori per periosteo, Osteotomi

3 mm

Steinhäuser
PST-26-6314
16.5 cm / 6 4/8"

5 mm

Steinhäuser
PST-26-6315
18 cm / 7 1/8"

8 mm

Steinhäuser
PST-26-6316
18 cm / 7 1/8"

PST-26-6317
6 mm

PST-26-6318
8 mm

Wolford
PST-26-6317 - PST-26-6318
21.5 cm / 8 4/8"

Ramusklammern
Ramus Clamps
Pinzas de rama
Clamps pour ramus
Pinze per ramo

PST-26-6319
rechts
right
derecho
droit

PST-26-6320
links
left
izquierdo
gauche
sinistra

Steinhäuser
PST-26-6320
16 cm / 6 2/8"

Steinhäuser
PST-26-6319
16 cm / 6 2/8"

Ramusosteotome, Meißel
Ramus Osteotomes, Chisels
Osteótomos de rama, Cinceles
Ostéotome pour ramus, Ciseaux-burins
Osteotomi per ramo, Scalpelli

Steinhäuser
PST-26-6321 - PST-26-6322
17 cm / 6 6/8"
flexibel
flexible
flexible
flexible
flessibile

PST-26-6321
7 mm

PST-26-6322
10 mm

PST-26-6323
7 mm

PST-26-6324
11 mm

PST-26-6325
15 mm

Steinhäuser
PST-26-6326
18 cm / 7 1/8"
Repositionsinstrument
Reposition Instrument
Instrumento de reposición
Pince de réposition
Strumento per riduzione

Steinhäuser
PST-26-6323 - PST-26-6325
19 cm / 7 1/8"

Tonsillektomie, Laryngo Bronchoskopie
Tonsillectomy Laryngo-Bronchoscopy
Tonsilectomia Laringo-Bronchoscopía
Tonsillectomie Laryngo-Bronchoscopie
Tonsilectomia Laringo-Bronchoscopia

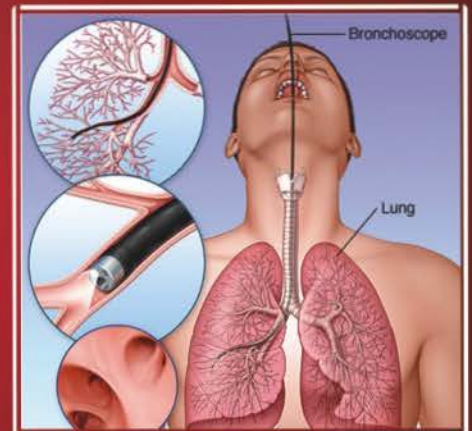

27

198 - 200

Kranio-Maxillofaziale Chirurgie
Cranic-Maxillo-Facial Surgery
Cirugia craneo-maxilofacial
Chirurge ou crane et maxillo-faciale
Chirurgia cranio- maxillo-facciale



28

201 - 208

Tonsillektomie,
Laryngo
Bronchoskopie

Tonsillectomy Laryngo-Bronchoscopy
Tonsilectomia Laringo-Bronchoscopia
Tonsillectomie Laryngo-Bronchoscopie
Tonsilectomia Laringo-Bronchoscopia

27



Quality Instruments

Gaumenspalten-Instrumente

Cleft Palate Instruments
Instrumentos paladares
Instruments pour palais
Strumenti per palato

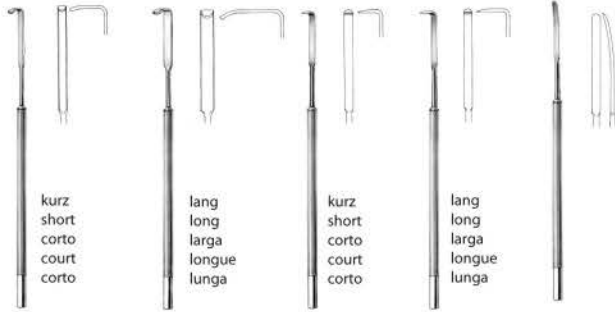

kurz
short
corto
court
corto

lang
long
larga
longue
lunga

kurz
short
corto
court
corto

lang
long
larga
longue
lunga

Salyer
PST-27-6401
18.5 cm / 7 2/8"

Salyer
PST-27-6402
18.5 cm / 7 2/8"

Salyer
PST-27-6403
18 cm / 7 2/8"

Salyer
PST-27-6404
18 cm / 7 2/8"

Salyer
PST-27-6405
18 cm / 7 2/8"

Gaumenspalten-Häkchen
Cleft Palate Hooklets
Ganchito para el paladar
Crochet pour palais
Uncino per palato

Gaumenspalten-Dissektor
Cleft Palate Dissector
Disecador para el paladar
Dissecteur pour palais
Disettore per palato



Gaumenspalten-Instrumente

Cleft Palate Instruments
Instrumentos paladares
Instruments pour palais
Strumenti per palato



Salyer
PST-27-6406
18 cm / 7 1/8"

Salyer
PST-27-6407
18 cm / 7 1/8"

JABOMA
PST-27-6408
17 cm / 6 5/8"

Gaumenspalten-Elevatorium
Cleft Palate Elevator
Elevador para el paladar
Élévateur pour palais
Elevatore per palato

Gaumenspalten-Elevatorium
Cleft Palate Elevator
Elevador para el paladar
Élévateur pour palais
Elevatore per palato

Gaumenspalten-Raspatorium
Cleft Palate Periosteal Elevator
Legra para el paladar
Raspatoir pour palais
Raspatore per palato



PST-27-6409
18 cm / 7 1/8"
links
left
izquierdo
gauche
sinistra



PST-27-6410
18 cm / 7 1/8"
rechts
right
derecho
droit
destra



Gaumennadeln, Tonsillenmesser

Cleft Palate Needles, Tonsil Knife
Agujas para sutura del paladar, Cuchillo
Aiguilles pour suturer du palais, Bistouri pour amygdales
Aghe per sutura del palato, Bisturi per tonsille



Hurd
PST-27-6411
20.5 cm / 8 1/8"
für rechte Hand
for right hand
para la mano derecha
pour main droite
per la mano destra

Hurd
PST-27-6412
20.5 cm / 8 1/8"
für linke Hand
for left hand
para la mano izquierda
pour main gauche
per la mano sinistra

Carpenter
PST-27-6414
25 cm / 9 7/8"
Tonsillenmesser- / Enucleator
Tonsil Knife- / Enucleator
Cuchillo / Enucléador para amígdalas
Bistouri et énucléateur pour amygdales
Bisturi / Enucléatore per tonsille

Fisher
PST-27-6413
22.5 cm / 8 7/8"

Brünings
PST-27-6415
23 cm / 9"



Tonsillenelevatorien

Tonsil Dissectors
Disectores para amígdalas
Dissecteurs pour amygdales
Disettori per tonsille

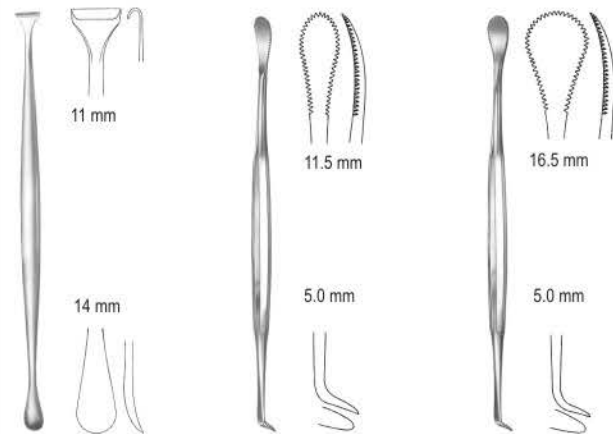

Hurd
PST-28-6816
22.5 cm / 8 2/8"

Henke
PST-27-6417
24.5 cm / 9 5/8"

Henke
PST-27-6418
24.5 cm / 9 5/8"

Tonsillenelevator / Retraktor
Tonsil Dissector / Retractor
Disector / Separador para amígdalas
Dissecteur / Rétracteur pour amygdales
Disettore / Retrattore per tonsille



Tonsillektomie,
Laryngo
Bronchoskopie

Tonsillectomy Laryngo-Bronchoscopy
Tonsillectomia Laringo-Bronchoscopia
Tonsillectomie Laryngo-Bronchoscopie
Tonsilectomia Laringo-Bronchoscopia

27



Quality Instruments

Tamponstopfer

Gauze Packers
Taponeadores
Porte-tampon
Tamponatori

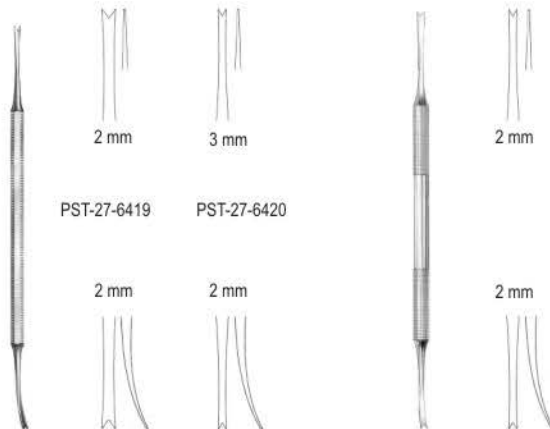

PST-27-6419 PST-27-6420

2 mm 2 mm 2 mm 2 mm

Luniatschek

PST-27-6419 - PST-27-6420
17.5 cm / 6 7/8"

Luniatschek

PST-27-6421
17.5 cm / 6 7/8"

Tonsillenklemmen

Tonsil Forceps
Pinzas para amígdalas
Pincers pour amygdales
Pinze per tonsille

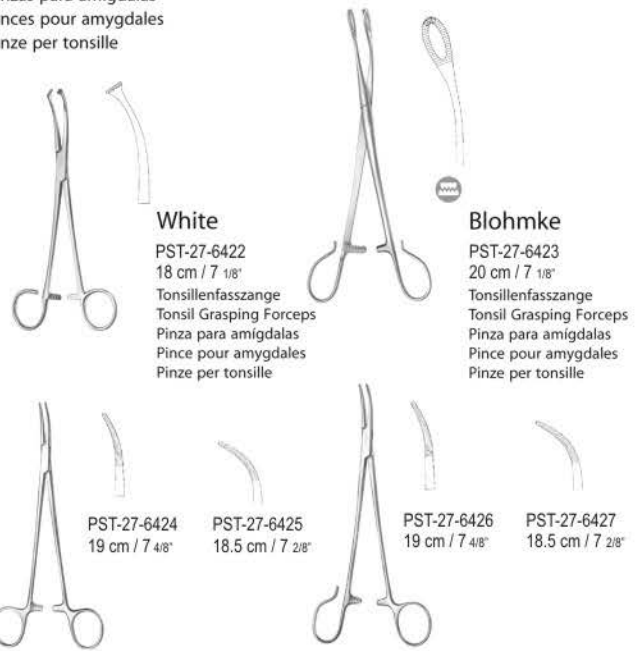

White

PST-27-6422
18 cm / 7 1/8"
Tonsillenfasszange
Tonsil Grasping Forceps
Pinza para amígdalas
Pince pour amygdales
Pinze per tonsille

Blohmke

PST-27-6423
20 cm / 7 1/8"
Tonsillenfasszange
Tonsil Grasping Forceps
Pinza para amígdalas
Pince pour amygdales
Pinze per tonsille

PST-27-6424
19 cm / 7 4/8"

PST-27-6425
18.5 cm / 7 2/8"

PST-27-6426
19 cm / 7 4/8"

PST-27-6427
18.5 cm / 7 2/8"

Schnidt

PST-27-6424 - PST-27-6425

Schnidt

PST-27-6426 - PST-27-6427

Tonsillenschnürer

Tonsil Snares
Cierra-nudos para amígdalas
Serre-nœuds pour amygdales
Serranodi per tonsille

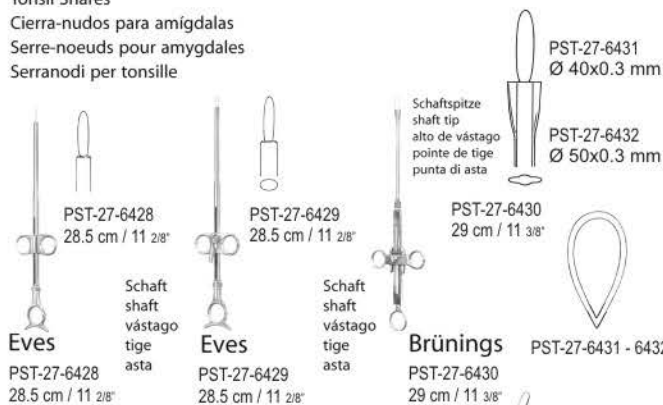

PST-27-6428
28.5 cm / 11 2/8"

PST-27-6429
28.5 cm / 11 2/8"

PST-27-6430
29 cm / 11 3/8"

PST-27-6431
Ø 40x0.3 mm

PST-27-6432
Ø 50x0.3 mm

Brünings PST-27-6431 - 6432

PST-27-6430
29 cm / 11 3/8"

Eves

PST-27-6428
28.5 cm / 11 2/8"

Eves

PST-27-6429
28.5 cm / 11 2/8"

Brünings

PST-27-6430
29 cm / 11 3/8"

Tyding

PST-27-6434

PST-27-6433
Ø 0.3 mm

Schnürdraht, Packung mit 100 Stück
Snare Wire, package of 100 pieces
Alambre para asas, paquete con 100 piezas
Fil pour anses, paquet avec 100 pièces
Filo per legare, confezione di 100 pezzi

mit einem geraden Aufsatz
with one straight tip
con una punta recta
avec une pointe droite
con una punta diritta

Broncho-Oesophagoskopiezangen

Broncho-Esophagoscopy Forceps
Pinzas para Broncho-Esofagoscopia
Pincers pour Broncho-Esofagoscopie
Pinze per Broncho-Esofagoscopia

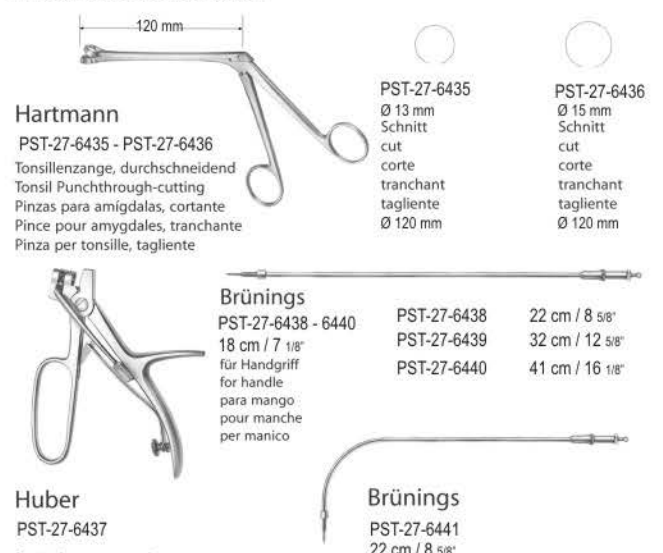

Hartmann

PST-27-6435 - PST-27-6436

Tonsillenzange, durchschneidend
Tonsil Punchthrough-cutting
Pinzas para amígdalas, cortante
Pince pour amygdales, tranchante
Pinza per tonsille, tagliente

PST-27-6435

Ø 13 mm
Schnitt
cut
corte
tranchant
tagliante
Ø 120 mm

PST-27-6436

Ø 15 mm
Schnitt
cut
corte
tranchant
tagliante
Ø 120 mm

Brünings

PST-27-6438 - 6440

18 cm / 7 1/8"
für Handgriff
for handle
para mango
pour manche
per manico

PST-27-6438

22 cm / 8 5/8"

PST-27-6439

32 cm / 12 5/8"

PST-27-6440

41 cm / 16 1/8"

Huber

PST-27-6437

für Verlängerungsröhre
for interchangeable tubes
para tubos de extension
pour tubes rallonges
per tubi allunghi

Brünings

PST-27-6441

22 cm / 8 5/8"
für Handgriff
for handle
para mango
pour manche
per manico

Tonsillektomie,
Laryngo
Bronchoskopie

Tonsillectomy Laryngo-Bronchoscopy
Tonsilectomia Laringo-Bronchoscopia
Tonsillectomie Laryngo-Bronchoscopia
Tonsilectomia Laringo-Bronchoscopia

27



Quality Instruments

Auswechselbare Zangenaufsätze

Exchangeable Tips
Pinzas intercambiables
Embouts interchangeables
Pinze intercambiabili



CASPAR
PST-27-6442-6449



Fraenkel
PST-27-6442



Seiffert
PST-27-6443



Fraenkel
PST-27-6444



Scheinmann
PST-27-6445



Scheinmann
PST-27-6446



Brünings
PST-27-6447



Brünings
PST-27-6448



Lange
PST-27-6449



Fig. 1



Fig. 3



Fig. 4



Fig. 3



Fig. 1

Auswechselbare Zangenaufsätze

Exchangeable Tips
Pinzas intercambiables
Embouts interchangeables
Pinze intercambiabili



CASPAR
PST-27-6450 - 6456



Krause
PST-27-6450



Cordes
PST-27-6451



Cordes
PST-27-6452



Rosenberg
PST-27-6453



Krause
PST-27-6454



Schumacher
PST-27-6455



Cordes
PST-27-6456



Fig. 1



Fig. 1



Fig. 2



Fig. 3



Fig. 4



Fig. 2



Fig. 1



Fig. 2



Kehlkopfspiegel

Laryngeal Mirrors
Espejos laringeos
Miroirs laryngiens
Specchi laringei



PST-27-6457 Ø 8.5 mm
PST-27-6458 Ø 10.5 mm
PST-27-6459 Ø 12.5 mm
PST-27-6460 Ø 14.5 mm
PST-27-6461 Ø 16.5 mm
PST-27-6462 Ø 18.5 mm
PST-27-6463 Ø 20.5 mm
PST-27-6464 Ø 22.5 mm
PST-27-6465 Ø 24.5 mm
PST-27-6466 Ø 26.5 mm
PST-27-6467 Ø 28.5 mm
PST-27-6468 Ø 30.5 mm



PST-27-6481 Ø 8.5 mm
PST-27-6482 Ø 10.5 mm
PST-27-6483 Ø 12.5 mm
PST-27-6484 Ø 14.5 mm
PST-27-6485 Ø 16.5 mm
PST-27-6486 Ø 18.5 mm
PST-27-6487 Ø 20.5 mm
PST-27-6488 Ø 22.5 mm
PST-27-6489 Ø 24.5 mm
PST-27-6490 Ø 26.5 mm
PST-27-6491 Ø 28.5 mm
PST-27-6492 Ø 30.5 mm

rhodiumbeschichtet
rhodium plated
cubierto de rodio
plaqué du rhodium
coperto di rodio

rhodiumbeschichtet
rhodium plated
cubierto de rodio
plaqué du rhodium
coperto di rodio

PST-27-6457
18.5 cm / 7 2/8"
plan, mit festem
Handgriff
plane, with fixed
handle
plano, con mango
fijado
plat, avec manche
fixe
plano, con manico
fisso

Fig. 00 PST-27-6469
Fig. 0 PST-27-6470 Ø 10.5 mm
Fig. 1 PST-27-6471
Fig. 2 PST-27-6472 Ø 14.5 mm
Fig. 3 PST-27-6473
Fig. 4 PST-27-6474 Ø 18.5 mm
Fig. 5 PST-27-6475
Fig. 6 PST-27-6476 Ø 22.5 mm
Fig. 7 PST-27-6477
Fig. 8 PST-27-6478 Ø 26.5 mm
Fig. 9 PST-27-6479
Fig. 10 PST-27-6480 Ø 30.5 mm

PST-27-6481
13.5 cm / 5 3/8"
plan, ohne
Handgriff
plane, without
handle
plano, sin
mango
plat, sans
manche
plano, senza
manico

Fig. 00 PST-27-6493 Ø 8.5 mm
Fig. 0 PST-27-6494 Ø 10.5 mm
Fig. 1 PST-27-6495 Ø 12.5 mm
Fig. 2 PST-27-6496 Ø 14.5 mm
Fig. 3 PST-27-6497 Ø 16.5 mm
Fig. 4 PST-27-6498 Ø 18.5 mm
Fig. 5 PST-27-6499 Ø 20.5 mm
Fig. 6 PST-27-6500 Ø 22.5 mm
Fig. 7 PST-27-6501 Ø 24.5 mm
Fig. 8 PST-27-6502 Ø 26.5 mm
Fig. 9 PST-27-6503 Ø 28.5 mm
Fig. 10 PST-27-6504 Ø 30.5 mm



Kehlkopfspiegel -und Griffe

Laryngeal Mirrors, Laryngeal Mirror Handles
Espejos laringeos, Mangos para espejos laringeos
Miroirs laryngiens, Manche pour miroirs laryngiens
Specchi laringei, Manico per specchi laringei



Michel

PST-27-6505 - PST-27-6508
27 cm / 10 5/8"
beweglicher Spiegel
moveable mirror
espejo movable
miroir mobile
specchio mobile



Fig. 1
PST-27-6505
Ø 12 mm



Fig. 2
PST-27-6506
Ø 14 mm



Fig. 3
PST-27-6507
Ø 16 mm



Fig. 4
PST-27-6508
Ø 18 mm



PST-27-6509
11 cm / 4 1/8"



PST-27-6510
12.5 cm / 4 7/8"

Kehlkopfpolypezangen

Laryngeal Polypus Forceps
Pinzas para pólipos laringeos
Pincers pour polypes laryngiens
Pinze per polipi laringei



Fig. 1
PST-27-6511



Fig. 2
PST-27-6512



Fig. 3
PST-27-6513



Fig. 4
PST-27-6514



Jurasz

PST-27-6511
- 6514
23 cm / 9"



Kranio-
Maxillofaziale
Chirurgie

Cranic-Maxillo-Facial Surgery
Cirugia craneo-maxilofacial
Chirurge ou crane et maxillo-faciale
Chirurgia cranio-maxillo-facciale

28



Quality Instruments

Weichteilhaken

Soft Tissue Retractors
Separadores para partes blandes
Ecarteurs pour parties molles
Divaricatori per tessuti molli



PST-28-6601
21.5 cm / 8 4/8"
16 x 5 mm

PST-28-6602
21 cm / 8 2/8"
25 x 7 mm

PST-28-6603
23 cm / 8"
35 x 10 mm

PST-28-6604
23 cm / 8"
42 x 10 mm

PST-28-6605
23.5 cm / 9 2/8"
55 x 13 mm

PST-28-6606
23.5 cm / 9 2/8"
67 x 15 mm

Obwegeser

PST-28-6601 - PST-28-6607
aufwärts gebogen
bent upwards
angulado hacia arriba
coudé en haut
angolato in alto

PST-28-6607
24 cm / 9 4/8"
80 x 17 mm

Weichteilhaken

Soft Tissue Retractors
Separadores para partes blandes
Ecarteurs pour parties molles
Divaricatori per tessuti molli



PST-28-6608
21 cm / 8 2/8"
16 x 5 mm

PST-28-6609
21 cm / 8 2/8"
25 x 7 mm

PST-28-6610
23 cm / 8"
35 x 10 mm

PST-28-6611
23 cm / 8"
42 x 10 mm

PST-28-6612
23.5 cm / 9 2/8"
55 x 12 mm

PST-28-6613
23.5 cm / 9 2/8"
66 x 15 mm

Obwegeser

PST-28-6608 - PST-28-6614
abwärts gebogen
bent downwards
angulado hacia abajo
coudé en bas

PST-28-6614
23.5 cm / 9 2/8"
80 x 16 mm

Unterkieferhaken, Ramushaken

Mandibular Retractors, Ramus Retractors
Separadores mandibulares, Separadores para el ramo
Ecarteurs mandibulaires, Ecarteurs pour ramus
Divaricatori mandibulari, Divaricatori per il ramo

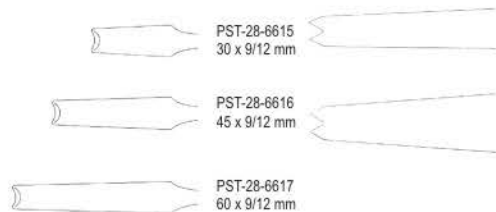

PST-28-6615
30 x 9/12 mm

PST-28-6618
75 x 11/15 mm

PST-28-6616
45 x 9/12 mm

PST-28-6619
75 x 12/22 mm

PST-28-6617
60 x 9/12 mm



Obwegeser

PST-28-6615 - PST-28-6617
21 cm / 8 7/8"

Obwegeser

PST-28-6618 - PST-28-6619
24 cm / 9 4/8"

Weisheitszahn-Haken, Spina nasalis-Haken

Third Molar Retractor, Nasal Spine Retractor
Separador para muela del juicio, Separador para espina nasal
Ecarteur pour dent de sagesse, Ecarteur pour spina nasalis
Separatore per il dente del giudizio, Separatore per spina nasale

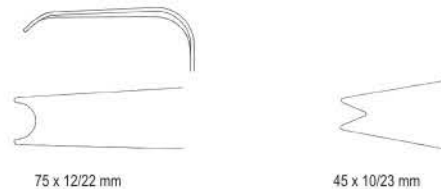

75 x 12/22 mm

45 x 10/23 mm

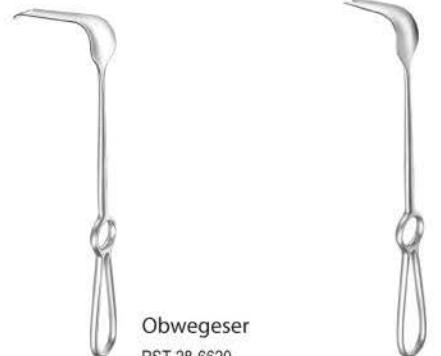

Obwegeser

PST-28-6620
24 cm / 9 4/8"

Obwegeser

PST-28-6621
24 cm / 9 4/8"

Kranio-
Maxillofaziale
Chirurgie

Cranic-Maxillo-Facial Surgery
Cirugia craneo-maxilofacial
Chirurgie ou crane et maxillo-faciale
Chirurgia cranio-maxillo-facciale

28



Quality Instruments

Ramusklammen, Progenierinnen

Ramus Clamps, Channel Retractors
Pinzas para el ramo, Separadores mandibulares
Pincers pour ramus, Ecarteurs mandibulaires
Pinze per il ramo, Divaricatori mandibulari

Obwegeser

PST-28-6622

16.5 cm / 6 4/8"

kleines Modell, rechts
small pattern, right
modelo pequeño, derecho
modèle petit, droite
modello piccolo, destro



Obwegeser

PST-28-6625

16.5 cm / 6 4/8"

kleines Modell, links
small pattern, left
modelo pequeño, izquierdo
modèle petit, gauche
modello piccolo, sinistra

Obwegeser

PST-28-6623

17 cm / 6 6/8"

Obwegeser

PST-28-6624

17 cm / 6 6/8"



PST-28-6626
16 cm / 6 2/8"
9 mm

PST-28-6627
16.5 cm / 6 4/8"
10 mm



16.5 mm

Obwegeser

PST-28-6628

16 cm / 6 2/8"

Kinnhalter
Chin Holder
Separador para mentón
Ecarteurs pour menton
Separatore per mento

Obwegeser

PST-28-6626 - PST-28-6627



Raspatorien

Periosteal Elevators
Periostótomos
Rugines-raspatoires
Periostotomi

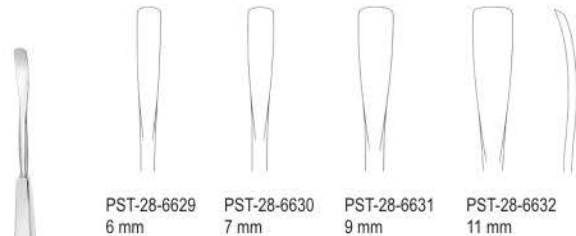

PST-28-6629
6 mm

PST-28-6630
7 mm

PST-28-6631
9 mm

PST-28-6632
11 mm

Obwegeser

PST-28-6629 - 6632

18 cm / 7 1/8"

winkelig angeschliffen
angled cutting
biselado angular
tranchant angulé
affilatura angolata

PST-28-6633
6 mm

PST-28-6634
7 mm

PST-28-6635
9 mm

PST-28-6636
11 mm

Obwegeser

PST-28-6633 - PST-28-6636

18 cm / 7 1/8"

flach angeschliffen
flat cutting
biselado plano
tranchant plat
affilatura plana



Unterkieferrand-Raspatorien, Schwalbenschwanz-Raspatorien

Mandibular Inferior Border Raspatories, Swallowtail Raspatories
Legras para el borde mandibular, Legras en forma de cola de milano
Rugine-raspatoires pour le bord mandibulaire, Rugine-raspatoires sous forme de Staccaperiostio per bordo mandibulare, Staccaperiostio a coda di rondine



6 mm



6 mm



10 mm



10 mm

Obwegeser

PST-28-6637

21 cm / 8 2/8"

Obwegeser

PST-28-6638

21 cm / 8 2/8"

Obwegeser

PST-28-6639

18 cm / 7 1/8"

nach links gewinkelt
angled to left
angulado hacia la izquierda
coudé à gauche
angolato a sinistra

Obwegeser

PST-28-6640

18 cm / 7 1/8"

nach rechts gewinkelt
angled to right
angulado hacia la derecha
coudé à droite
angolato a destra

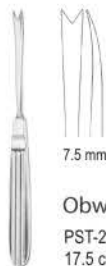

7.5 mm

Obwegeser

PST-28-6641

17.5 cm / 6 7/8"



11 mm

Obwegeser

PST-28-6642

17.5 cm / 6 7/8"



Ramusraspatorien, Septumosteotome

Ramus Periosteal Elevators, Septonasal Osteotomes
Legras para el ramo, Osteótomos para el tabique nasal
Rugine-raspatoires pour ramus, Ostéotomes pour cloison nasale
Elevatori periostali per ramo, Osteotomo per setto nasale



PST-28-6643
5 mm



PST-28-6644
7 mm



PST-28-6645
9 mm

Obwegeser

PST-28-6643 - PST-28-6645

21 cm / 8 4/8"



Obwegeser

PST-28-6646 - 6648

19 cm / 7 4/8"

graduirt
graduated
graduado
gradué
graduato



PST-28-6646
4 mm



PST-28-6647
6 mm



PST-28-6648
8 mm



Kranio-
Maxillofaziale
Chirurgie

Cranic-Maxillo-Facial Surgery
Cirugia craneo-maxilofacial
Chirurgie ou crane et maxillo-faciale
Chirurgia cranio-maxillo-facciale



Quality Instruments

28

Keilosteotome, Blattosteotome

Wedge Osteotomes, Blade Osteotomes
Osteótomos de cuña, Osteótomos de hoja
Ostéotome cunéiforme, Ostéotome en lame
Osteotomo a forma di cono, Osteotomo



PST-28-6649
8 mm

PST-28-6650
12 mm

PST-28-6651
16 mm



Obwegeser

PST-28-6649 - PST-28-6651
22.5 cm / 8 7/8"

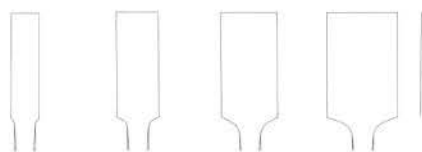

PST-28-6652
8 mm

PST-28-6653
12 mm

PST-28-6654
16 mm

PST-28-6655
20 mm

Obwegeser
PST-28-6652 - PST-28-6655
22.5 cm / 8 7/8"

Fragment-Adaptierungsklemmen

Fragment Adapting Forceps
Pinzas adaptadoras para fragmentos
Clamps pour adaptation de fragments osseux
Pinze per avvicinare frammenti

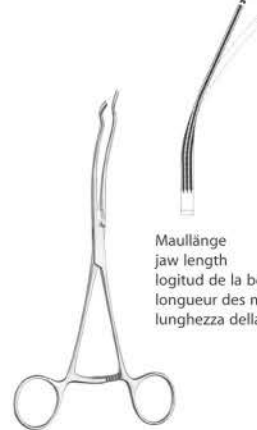

Obwegeser

PST-28-6656
21 cm / 8 2/8"
links
left
izquierdo
gauche
sinistra

Maullänge
jaw length
logitud de la boca
longueur des mors
lunghezza della bocca

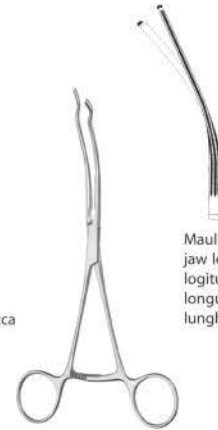

Obwegeser

PST-28-6657
21 cm / 8 2/8"
rechts
right
derecho
droit
destra

Maullänge
jaw length
logitud de la boca
longueur des mors
lunghezza della bocca

Tuber maxillae-Osteotome, Osteotome, Alveolarfortsatz-Osteotome

Osteotomes for Maxillary Tuber, Osteotomes, Osteotomes for Alveolar Process
Osteótomos para tubérculo maxilar, Osteótomos, Osteótomos para el proceso alveolar
Ostéotome pour tuber-maxillae, Ostéotomes, Ostéotome pour bord alvéolaire
Osteotomo per tuberosità mascellari, Osteotomo, Osteotomo per processo alveolare

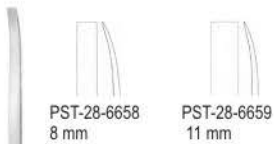

PST-28-6658
8 mm

PST-28-6659
11 mm



PST-28-6660
8 mm

PST-28-6661
11 mm

Obwegeser

PST-28-6658 - PST-28-6659
23 cm / 9"

Obwegeser

PST-28-6660 - PST-28-6661
21 cm / 8 2/8"
elastische Klinge
elastic blade
hoja elástica
lame élastique
lama elastica



PST-28-6662
3 mm

PST-28-6663
4 mm

PST-28-6664
6.5 mm

Obwegeser

PST-28-6662 - PST-28-6664
15.5 cm / 6 1/8"



Obwegeser

PST-28-6665
23 cm / 9"
Maxilla-Mobilisator
Maxillary Mobilizer
Mobilizador maxilar
Mobilisateur pour maxillaire
Mobilizzatore per mascella

Unterkieferahlen, Jochbogenahle

Maxillary Awls, Zygomatic Arch Awl
Leznas maxilares, Lezna para el arco cigomático
Alènes maxillaires, Alène pour l'arcade zygomatique
Punteruolo per mandibola, Punteruolo per arco zigomatico



Obwegeser

PST-28-6666
15 cm / 5 7/8"



Obwegeser

PST-28-6667
17.5 cm / 6 7/8"



Obwegeser

PST-28-6668
24 cm / 9 4/8"

Kranio-
Maxillofaziale
Chirurgie

Cranic-Maxillo-Facial Surgery
Cirugia craneo-maxilofacial
Chirurge ou crane et maxillo-faciale
Chirurgia cranio-maxillo-facciale

28



Quality Instruments

Drahtschneidezange, Flachzangen, Drahtzwirbelzangen

Wire Cutter, Flat Nose Pliers, Wire Twisting Forceps
Alicates para alambre, Alicates de pico plano, Pinzas para torcer alambre
Pincers à couper le fil, Pincers plate, Pincers à torsader le fil
Tronchesino, Tenaglia piatta, Pinze per ritorcere fili

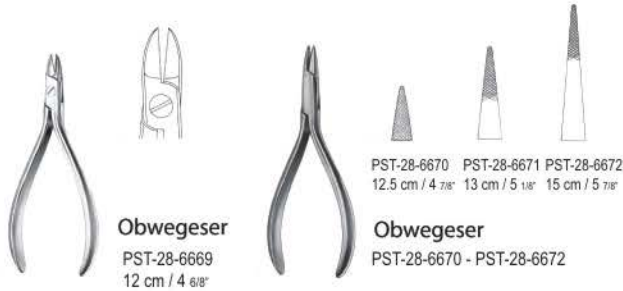

Obwegeser
PST-28-6669
12 cm / 4 3/8"

PST-28-6670 PST-28-6671 PST-28-6672
12.5 cm / 4 7/8" 13 cm / 5 1/8" 15 cm / 5 7/8"

Obwegeser
PST-28-6670 - PST-28-6672



Obwegeser
PST-28-6673
13 cm / 5 1/8"

TC GOLD

PST-28-6674 PST-28-6675

breites Maul
wide jaw
amplia boca
gueule large
bocca ampia

Obwegeser
PST-28-6674 - PST-28-6675
14 cm / 5 4/8"



Knochenformzangen, Hauthäkchen, Kopfhautklemme

Bone Contouring Forceps, Skin Hooklet, Scalp Clamp
Pinzas para formar huesos, Ganchito para piel, Pinza para cabelludo
Pincers pour former os, Crochet pour peau, Pince pour le cuir chevelu
Pinze per afferrare ossa, Gancio per cute, Pinza per cuoio capelluto

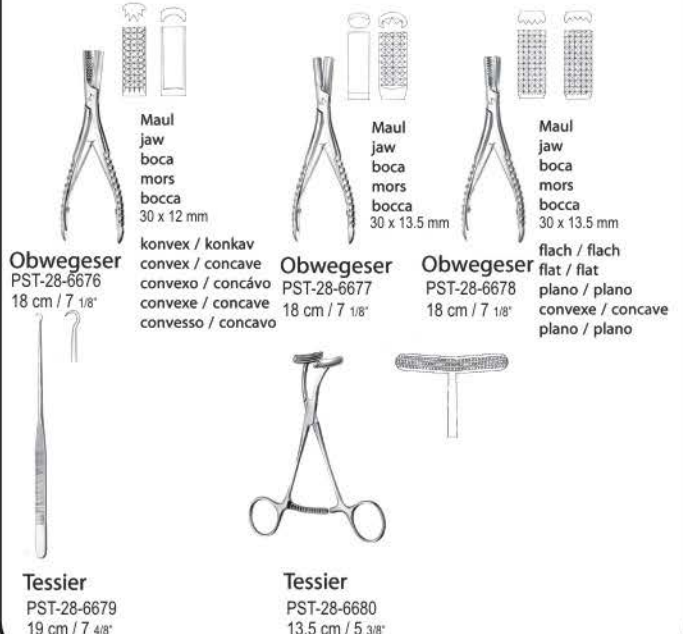

Maul jaw boca mors bocca
30 x 12 mm

Obwegeser
PST-28-6676
18 cm / 7 1/8"

Maul jaw boca mors bocca
30 x 13.5 mm

Obwegeser
PST-28-6677
18 cm / 7 1/8"

Maul jaw boca mors bocca
30 x 13.5 mm

Obwegeser
PST-28-6678
18 cm / 7 1/8"

konvex / konkav
convex / concave
convexo / concavo
convexe / concave
convesso / concavo

Tessier
PST-28-6679
19 cm / 7 4/8"

flach / flach
flat / flat
plano / plano
convexe / concave
plano / plano

Tessier
PST-28-6680
13.5 cm / 5 3/8"

flach / flach
flat / flat
plano / plano
convexe / concave
plano / plano



Nasenspekula

Nasal Specula
Espéculos nasales
Spéculum nasaux
Specoli nasali



Tessier
PST-28-6681 - PST-28-6683
schwarz verchromt
black chromium-plated
cromado en negro
chromé noir
cromato nero

PST-28-6681
13.5 cm / 5 3/8"

Blätter
blades
hojas
lames
lame
35 mm

PST-28-6682
14 cm / 5 4/8"

Blätter
blades
hojas
lames
lame
45 mm

PST-28-6683
15.5 cm / 6 1/8"

Blätter
blades
hojas
lames
lame
70 mm



Osteotome

Osteotomes
Osteótomos
Ostéotomes
Osteotomo

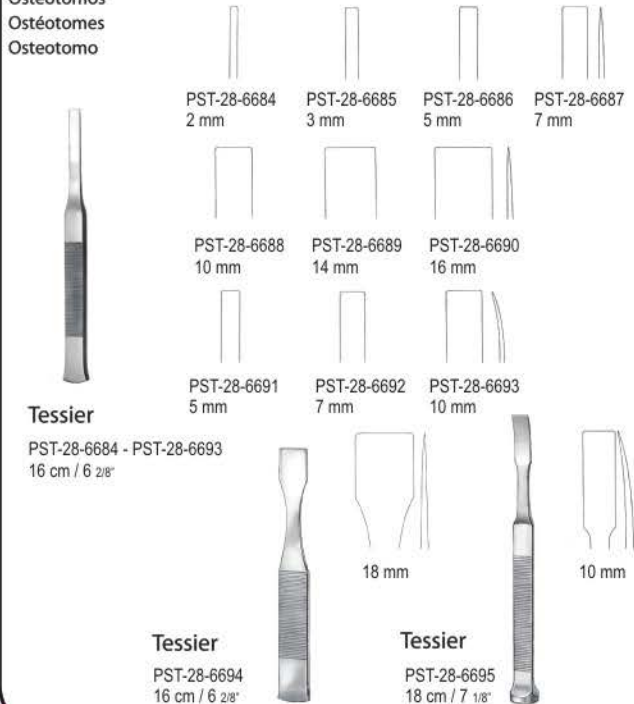

Tessier
PST-28-6684 - PST-28-6693
16 cm / 6 2/8"

PST-28-6684
2 mm

PST-28-6685
3 mm

PST-28-6686
5 mm

PST-28-6687
7 mm

PST-28-6688
10 mm

PST-28-6689
14 mm

PST-28-6690
16 mm

PST-28-6691
5 mm

PST-28-6692
7 mm

PST-28-6693
10 mm

Tessier
PST-28-6694
16 cm / 6 2/8"

Tessier
PST-28-6695
18 cm / 7 1/8"



Kranio-
Maxillofaziale
Chirurgie

Cranic-Maxillo-Facial Surgery
Cirugia craneo-maxilofacial
Chirurge ou crane et maxillo-faciale
Chirurgia cranio-maxillo-facciale

28



Quality Instruments

Osteotome

Osteotomes
Osteótomos
Ostéotomes
Osteotomo

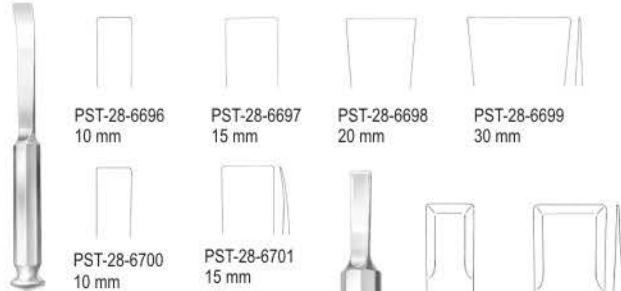

PST-28-6696
10 mm

PST-28-6697
15 mm

PST-28-6698
20 mm

PST-28-6699
30 mm

PST-28-6700
10 mm

PST-28-6701
15 mm

PST-28-6702
10 mm

PST-28-6703
15 mm

PST-28-6704
10 mm

PST-28-6705
15 mm

Tessier

PST-28-6696 - PST-28-6701
20 cm / 7 7/8"

zur Transplantatentnahme aus Ilium und Tibia
for taking grafts from ilium and tibia
par sacar transplantes del ilion y la tibia
pour prise de greffon de l'ilion et du tibia
per prendere innesti dall'ileo e tibia

Tessier

PST-28-6702 - PST-28-6705
16 cm / 6 2/8"

zur Transplantatentnahme aus der Calva
for taking grafts from the calva
par sacar transplantes del calvo

Thoraxhaken

Thoracic Retractors
Separadores torácico
Rétracteur thoracique
Divaricatore per torace

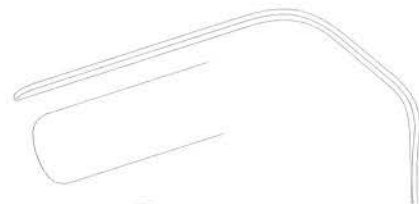

PST-28-6706
21 cm / 8 2/8"
90 x 22 mm

PST-28-6707
26.5 cm / 10 3/8"
120 x 28 mm

Tessier

PST-28-6706 - PST-28-6707

schwarz verchromt
black chromium-plated
cromado en negro
chromé noir
cromato nero

Beckenkammspatel

Iliac Crest Retractors
Separadores para cresta iliaca
Rétracteur iliaque
Divaricatore per cresta iliaca



PST-28-6708
16.5 cm / 6 4/8"
36 x 50 mm

PST-28-6709
17.5 cm / 6 7/8"
52 x 50 mm

PST-28-6710
17.5 cm / 6 7/8"
59 x 50 mm

PST-28-6711
18 cm / 7 1/8"
66 x 50 mm

Tessier

PST-28-6708 - PST-28-6711

schwarz verchromt
black chromium-plated
cromado en negro
chromé noir
cromato nero

Knochenhaltezzangen, Knochensplitterzangen

Bone Holding Forceps, Bone Cutting Forceps
Pinzas para huesos, Cizallas para huesos
Pincos pour os, Pincos coupantes à os
Pinze per ossa, Pinze per ossa

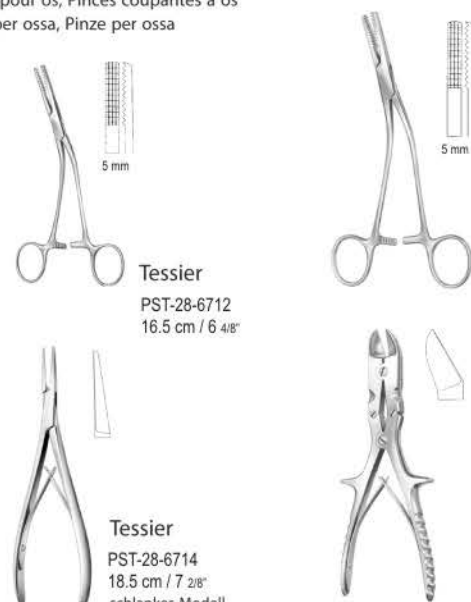

5 mm

5 mm

Tessier

PST-28-6712
16.5 cm / 6 4/8"

Tessier

PST-28-6713
18 cm / 7 1/8"

Tessier

PST-28-6714
18.5 cm / 7 2/8"
schlankes Modell
slender pattern
modelo delgado
modèle gracile
modello delicato

Tessier

PST-28-6715
22 cm / 8 5/8"

Kranio-
Maxillofaziale
Chirurgie

Cranic-Maxillo-Facial Surgery
Cirugia craneo-maxilofacial
Chirurgie ou crane et maxillo-faciale
Chirurgia cranio-maxillo-facciale

28



Quality Instruments

Periostraspatorien, Ahlen

Periosteal Elevators, Awls
Legras para periostio, Leznas
Rugine-raspatoires pour périoste, Alènes
Elevatori periostali, Punteruoli



konvex/konkav
convex/concave
convexo/cóncavo
convexe/concave
convesso/concavo



Tessier
PST-28-6716
22 cm / 8 5/8"

Tessier
PST-28-6717
18 cm / 7 1/8"

Tessier
PST-28-6718
18 cm / 7 1/8"



Tessier
PST-28-6719 - PST-28-6720
20.5 cm / 8 1/8"

Tessier
PST-28-6721
21 cm / 8 2/8"
Ø 2.5 mm

Tessier
PST-28-6722
16.5 cm / 6 4/8"
Ø 4.5 mm

Tessier
PST-28-6723
14 cm / 5 4/8"
Ø 2.0 mm



Weichteilhaken

Soft Tissue Retractors
Separadores para partes blandas
Ecarteurs pour parties molles
Divaricatori per tessuti molli



PST-28-6727
14.5 cm / 5 3/8"
30 x 12 / 35 x 16 mm



PST-28-6728
15 cm / 5 7/8"
35 x 12 / 45 x 16 mm



PST-28-6729
16 cm / 6 2/8"
50 x 12 / 70 x 16 mm



Spatel
Spatula
Espátulas
Spatules
Spatola



PST-28-6724
10 - 12 mm

PST-28-6725
15 - 17 mm

PST-28-6726
20 - 22 mm

Tessier

PST-28-6724 - PST-28-6726
22 cm / 8 5/8"
schwarz verchromt, konisch, biegsam
black chromium-plated, conical, malleable
cromado en negro, cónico, maleable
chromé noir, conique, malléable
cromato nero, conico, malleabili

Tessier

PST-28-6727 - PST-28-6729
schwarz verchromt
black chromium-plated
cromado en negro
chromé noir
cromato nero



Weichteilhaken

Soft Tissue Retractors
Separadores para partes blandas
Ecarteurs pour parties molles
Divaricatori per tessuti molli



PST-28-6731
15 cm / 5 7/8"
20 x 13 / 30 x 15 mm



PST-28-6732
15.5 cm / 6 1/8"
28 x 13 / 36 x 15 mm



PST-28-6733
15.5 cm / 6 1/8"
33 x 12 / 43 x 15 mm



50 x 12 / 68 x 16 mm

19 x 7 / 29 x 10 mm



Tessier
PST-28-6730
15 cm / 5 7/8"

schwarz verchromt
black chromium-plated
cromado en negro
chromé noir
cromato nero

Tessier
PST-28-6731 - PST-28-6733

Tessier
PST-28-6734
16 cm / 6 2/8"



Weichteilhaken

Soft Tissue Retractors
Separadores para partes blandas
Ecarteurs pour parties molles
Divaricatori per tessuti molli



Fig. 1
PST-28-6735
8 mm



Fig. 2
PST-28-6736
10 mm



Fig. 3
PST-28-6737
7 mm



Fig. 4
PST-28-6738
10 mm



Fig. 5
PST-28-6739
8 mm



Fig. 6
PST-28-6740
12 mm



Tessier
PST-28-6735 - PST-28-6737
12.5 cm / 4 7/8"
schwarz verchromt
black chromium-plated
cromado en negro
chromé noir
cromato nero



Tessier
PST-28-6738 - PST-28-6740
12.5 cm / 4 7/8"
schwarz verchromt
black chromium-plated
cromado en negro
chromé noir
cromato nero



Kranio-
Maxillofaziale
Chirurgie

Cranic-Maxillo-Facial Surgery
Cirugia craneo-maxilofacial
Chirurgie ou crane et maxillo-faciale
Chirurgia cranio-maxillo-facciale

28



Quality Instruments

Sattelhäkchen, Osteotome

Saddle Hooklets, Osteotomes
Ganchitos en forma de silla, Osteótomos
Crochet sous forme de selle, Ostéotomes
Guanci a froma di sella, Osteotomo



Tessier

PST-28-6741 - PST-28-6743

schwarz verchromt
black chromium-plated
cromado en negro
chromé noir
cromato nero



PST-28-6741
15 cm / 5 7/8"
10 mm



PST-28-6742
15 cm / 5 7/8"
17.5 mm



PST-28-6743
15.5 cm / 6 1/8"
20.5 mm



Tessier

PST-28-6744
19 cm / 7 4/8"



Tessier

PST-28-6745
18 cm / 7 1/8"



PST-28-6746
22 cm / 8 5/8"

Präparierscheren, Drahtscheren

Dissecting Scissors, Wire Cutting Scissors
Tijeras para preparaciones, Tijeras para alambre
Ciseaux à dissection, Ciseaux à couper le fil
Forbici per dissezione, Tronchesino



Tessier

PST-28-6747
13 cm / 5 1/8"

Unterminierschere
Undermining Scissors
Tijera para minar
Ciseaux à tunéliser
Forbici per tunnelare



TC GOLD

Tessier

PST-28-6748
15 cm / 5 7/8"



Tessier

PST-28-6749
16.5 cm / 6 4/8"



Tessier

PST-28-6750
12 cm / 4 6/8"

Repositionszangen

Disimpaction Forceps
Pinzas de reposición
Pince à repositionner
Pinze per riduzione



PST-28-6751

links
left
izquierda
gauche
sinistra



PST-28-6752

rechts
right
derecha
droite
destra

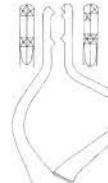

PST-28-6753

links
left
izquierda
gauche
sinistra

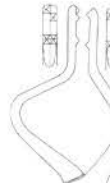

PST-28-6754

rechts
right
derecha
droite
destra



Tessier

PST-28-6751 - PST-28-6752

23 cm / 9"
links, für Kinder
left, for children
izquierda, para niños
gauche, pour enfants
sinistra, per bambini



Tessier

PST-28-6753 - PST-28-6754

23 cm / 9"
rechts, für Kinder
right, for children
derecha, para niños
droite, pour enfants
destra, per bambini

Schieblehre, Knochenhaken

Caliper, Bone Hook
Calibre, Gancho para huesos
Calibre, Crochet pour os
Calibro, Gancio per ossa



Tessier

PST-28-6755

19 cm / 7 4/8"
schwarz verchromt
black chromium-plated
cromado en negro
chromé noir
cromato nero



Tessier

PST-28-6756

17 cm / 6 5/8"
Sprezzange
Spreading Forceps
Pinza de expansión
Pince à écarter
Pinze per allargare

Kranio-
Maxillofaziale
Chirurgie

Cranic-Maxillo-Facial Surgery
Cirugia craneo-maxilofacial
Chirurgie ou crane et maxillo-faciale
Chirurgia cranio-maxillo-facciale

28



Quality Instruments

Mobilisierhaken, Raspatorien

Mobilizing Retractors, Periosteal Elevators
Separadores de mobilización, Periostótomos
Crochet de mobilisation, Rugines-raspatoires
Divaricatori per mobilizzazione, Periostotomi



Tessier
PST-28-6757
15 cm / 5 7/8"
rechts
right
derecho
droit
destra



Tessier
PST-28-6758
15 cm / 5 7/8"
links
left
izquierdo
gauche
sinistra



Marchac
PST-28-6759 - PST-28-6760
16 cm / 6 2/8"



PST-28-6759 7.5 mm
PST-28-6760 12 mm



Marchac
PST-28-6761 - PST-28-6763
17 cm / 6 6/8"



PST-28-6761 2 mm
PST-28-6762 3.5 mm
PST-28-6763 5 mm



Schablonen, Messlehre, Elevatorien

Templates, Caliper, Elevators
Plantillas, Caliper, Elevadores
Gabarits, Calibre, Elévateurs
Sagome, Calibro, Elevatori



Marchac
PST-28-6764
Frontschablonen
Frontal Templates
Plantillas frontales
Gabarit frontal
Sagome frontali
für Kleinkinder
for infants
para bebés
pour bébés
per neonati



Marchac
PST-28-6765
Frontschablonen
Frontal Templates
Plantillas frontales
Gabarit frontal
Sagome frontali
für Kinder und Erwachsene
for children and adults
para niños y adultos
pour enfants et adultes
per bambini ed adulti



Marchac
PST-28-6766
Messbereich
effective range
alcance eficaz
série effectif
rango effective



Steinberg
PST-28-6767
18 cm / 7 1/8"



Steinberg
PST-28-6768
19.5 cm / 7 5/8"



Elevatorien, Ramushaken

Elevators, Ramus Retractors
Elevadores, Separadores para el ramo
Elévateurs, Ecarteurs pour ramus
Elevatori, Divaricatori per il ramo

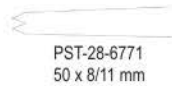

PST-28-6771
50 x 8/11 mm



PST-28-6772
60 x 9/13 mm



Steinberg
PST-28-6769
22.5 cm / 8 7/8"



Steinberg
PST-28-6770
18.5 cm / 7 2/8"



Steinberg
PST-28-6771 - PST-28-6772
22 cm / 8 5/8"



Aspirations-Dissektor, Osteotome

Suction Dissector, Osteotomes
Dissecador de aspiración, Osteotomos
Dissecteur à aspiration, Osteotomes
Dissettore a aspirazione, Osteotomi



Marchac
PST-28-6773
19 cm / 7 4/8"



Marchac
PST-28-6774 - PST-28-6776
18.5 cm / 7 2/8"



PST-28-6774 4 mm
PST-28-6775 6 mm
PST-28-6776 8 mm

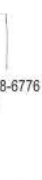
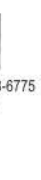
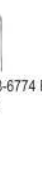

Ösenzange

Eyelet forceps
Alicate de orificios
Pince de trous
Pinza di fori



Obwegeser
PST-28-6779
15 cm / 5 7/8"

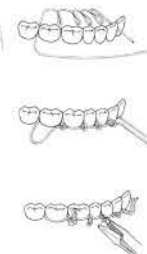

Marchac
PST-28-6780
20 cm / 7 7/8"



Hygiene, Aufbewahrung
Hygiene, Storage
Higiene, Almacenaje
Hygiene, Stockage
Igiene, Magazzinaggio



29

209- 210

Gefäße aus Edelstahl
Stainless Steel Receptacles
Recipientes de acero inoxidable
Récipients en acier inoxydable
Recipienti di acciaio inossidabile

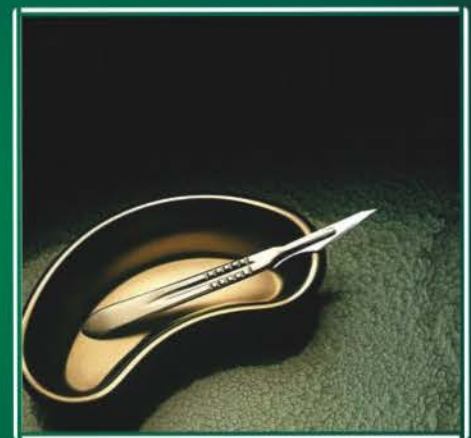

30

211 - 212

Hygiene
Aufbewahrung

Hygiene, Storage
Higiene, Almacenaje
Hygiene, Stockage
Igiene, Magazzinaggio

29



Quality Instruments

Sterilisierzangen, Petrischalengestell

Sterilizing Forceps, Storage Rack for Petri Dishes
Pinzas para esterilización, Caballete para cápsulas de Petri
Pincers pour instruments stérilisés, Support pour boîtes de Petri
Pinze per strumenti sterilizzati, Supporti per piatti Petri



Cheattle
PST-29-6801
27 cm / 10 5/8"



PST-29-6802
30 cm / 11 5/8"



PST-29-6803

für bis zu 10 Schalen mit Ø 8 - 10 cm, mit Fixiervorrichtung
for up to 10 dishes of Ø 8 - 10 cm, with fixation device
para hasta 10 cápsulas de Ø 8 - 10 cm, con dispositivo de fijación
pour jusqu'à 10 boîtes de Ø 8 - 10 cm, avec dispositif de fixation



PST-30-6204

für bis zu 10 Schalen mit Ø 8 - 10 cm, mit Fixiervorrichtung
for up to 10 dishes of Ø 8 - 10 cm, with fixation device
para hasta 10 cápsulas de Ø 8 - 10 cm, con dispositivo de fijación
pour jusqu'à 10 boîtes de Ø 8 - 10 cm, avec dispositif de fixation
per fina a 10 bucce da Ø 8 - 10 cm, con dispositivo di fissazione

Verbandstofftrommeln, Nadeletuis

Dressing Sterilizing Drums, Needle Cases
Tambores para esterilización, Estuches para agujas
Boîtes pour stérilisation de pansements, Boîtes pour aiguilles
Scatole per sterilizzare bendaggi, Scatole per aghi

St 18/8



Schimmelbusch

PST-29-6805 - PST-30-6217

ohne Filter, seitlich perforiert, durch Schieber verschließbar
without filter, laterally perforated, lockable by sliding mechanism
sin filtro, lateralmente perforado, cerradura por mecanismo correzido
sans filtre, perforé latéralment, fermeture par éclisse
senza filtro, perforato lateralmente, con serratura a spintore

Ø x h
PST-29-6805 = 140 x 140 mm
PST-29-6806 = 160 x 120 mm
PST-29-6807 = 160 x 150 mm
PST-29-6808 = 190 x 150 mm
PST-29-6809 = 190 x 190 mm
PST-29-6810 = 240 x 160 mm
PST-29-6811 = 240 x 240 mm
PST-29-6812 = 290 x 160 mm
PST-29-6813 = 290 x 240 mm
PST-29-6814 = 340 x 160 mm
PST-29-6815 = 340 x 240 mm
PST-29-6816 = 390 x 190 mm
PST-29-6817 = 390 x 290 mm



Sauerbruch

PST-29-6818
210 x 125 x 17 mm

Deckel und Boden perforiert
perforated lid and bottom
tapa y fondo perforado
couvercle et fond perforé
coperchio e fondo perforati



Sauerbruch

PST-29-6819
210 x 125 x 17 mm

Deckel und Boden perforiert
perforated lid and bottom
tapa y fondo perforado
couvercle et fond perforé
coperchio e fondo perforati

Lagerungsetuis, Nadeldosen

Storage Cases, Needle Cases
Cajas para almacenaje, Estuches para agujas
Boîtes pour stockage, Boîtes pour aiguilles
Scatole per magazzinaggio, Scatole per aghi

St 18/8



PST-29-6820
120 x 65 x 13 mm
ohne Inhalt
without contents
sin contenido
sans contenu
senza contenuto



PST-29-6821

Silikonband, zur Lagerung von Mikro-Bulldogclips
Silicone Tape, for storing micro bulldog clips
Cinta de silicona, para almacenar micro bulldog clips
Bande en silicone, pour stockage de micro clips
Nastro in silicone, per magazzinaggio di micro-clips

PST-29-6822

120 x 65 x 13 mm
mit Spiralfeder, ohne Inhalt
with spiral spring, without contents
con resorte espiral, sin contenido
avec ressort en spirale, sans contenu
con molla a spirale, senza contenuto



PST-29-6823

50 x 25 x 4.5 mm



PST-29-6824

65 x 42 x 8 mm



PST-29-6825

75 x 25 x 4.5 mm

PST-29-6826

50 x 25 x 4.5 mm

PST-29-6827

65 x 42 x 8 mm

PST-29-6828

75 x 25 x 4.5 mm

Nadeldosen

Needle Cases
Estuches para agujas
Boîtes pour aiguilles
Scatole per aghi

St 18/8



PST-29-6829
h = 18 mm Ø 67 mm

komplett mit perforierter Innendose
complete with perforated interior box
completa con caja interior perforada
complet avec boîte intérieure perforée
completo con scatola interiore perforata



Martin-Propor
PST-29-6831
h = 63 mm Ø 78 mm

mit Schlitz im Deckel, zur Aufnahme gebrauchter Bohrer
slotted lid, for disposal of used burs
tapa con hendidura, para sacar fresas usadas
avec fente dans le couvercle, pour la prise des mèches utilisées
con fessura nel coperchio, per buttare via punte usate



PST-29-6830
h = 15 mm Ø 61 mm

Innendose, Deckel und Boden perforiert
Interior Box, perforated lid and bottom
Caja interior, tapa y fondo perforado
Boîte intérieure, couvercle et fond perforé
Scatola per aghi, coperchio e fondo perforati



PST-29-6832
150 x 95 x 13 mm

PST-29-6833
150 x 95 x 13 mm

Deckel und Boden perforiert
perforated lid and bottom
tapa y fondo perforado
couvercle et fond perforé
coperchio e fondo perforati



PST-29-6834
150 x 95 x 13 mm

Boden perforiert
perforated bottom
fondo perforado
fond perforé
fondo perforato



PST-29-6835
150 x 95 x 13 mm

Deckel und Boden perforiert
perforated lid and bottom
tapa y fondo perforado
couvercle et fond perforé
coperchio e fondo perforati

★★★★★

★★★★★

Hygiene
Aufbewahrung

Hygiene, Storage
Higiene, Almacenaje
Hygiene, Stockage
Igiene, Magazzinaggio

29



Quality Instruments

Sterilisierklammer

Safety Pins
Imperdibles para instrumentos
Clips de stérilisation
Pinze per sterilizzazione



Mayo
PST-29-6836
14 cm / 5 4/8"

Mayo
PST-29-6837
14 cm / 5 4/8"

Siebschalen

Trays
Bandejas
Plateaux
Cestelli

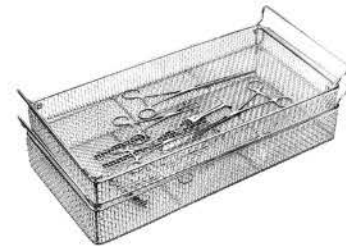

PST-29-6838
Drahtgeflecht
wire mesh
malla de alambre
grillage en fil métallique
griglia in metallo



PST-29-6839
Lochblech
perforated steel sheet
chapa perforada
tôle perforée
lamiera perforata



Sterilisierkörbe

Sterilizing Baskets
Bandejas para esterilización
Plateaux de stérilisation
Cestelli per sterilizzazione



PST-29-6840
600 x 300 x 260 mm



PST-29-6841
600 x 300 x 130 mm



**Gefäße aus
Edelstahl**

Stainless Steel Receptacles
Recipientes de acero inoxidable
Réceptifs en acier inoxydable
Recipienti di acciaio inossidabile

30



Quality Instruments

Runde Schüsseln, Flachschaalen

Round Bowls, Flat Dishes
Cubetas redondas, Cubetas planas
Cuvettes rondes, Cuvettes plates
Scodelle rotonde, Scodelle piatte

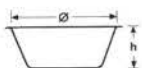

St 18/8



PST-30-6901 - PST-30-6909

PST-30-6901 Ø 150 x 74 mm 750 ccm
PST-30-6902 Ø 160 x 65 mm 1.000 ccm
PST-30-6903 Ø 220 x 70 mm 2.000 ccm
PST-30-6904 Ø 240 x 95 mm 3.000 ccm

PST-30-6905 Ø 260 x 130 mm 4.000 ccm
PST-30-6906 Ø 300 x 105 mm 6.000 ccm
PST-30-6907 Ø 320 x 140 mm 8.000 ccm

PST-30-6908 Ø 380 x 125 mm 11.000 ccm
PST-30-6909 Ø 400 x 150 mm 14.000 ccm



PST-30-6910 Ø 330 mm x 90 mm 6.000 ccm
PST-30-6911 Ø 330 mm x 115 mm 8.000 ccm



PST-30-6912
Deckel, allein
Lid only
Tapa suelta
Couvercle seul
Coperchio solo



PST-30-6913 Ø 110 mm x 25 mm 150 ccm
PST-30-6914 Ø 110 mm x 40 mm 250 ccm

Metallschalen, Messbecher, Petrischalen

Stainless Steel Bowls, Measurers, Petri Dishes
Cubetas de acero inoxidable, Vaso-medidas, Cápsulas de Petri
Cuvettes de acier inoxydable, Mesures graduées, Boîtes de Petri
Scodelle di acciaio inossidabile, Bicchieri graduati. Scodella di Petri

St 18/8



PST-30-6928 Ø 110 x 28 mm 150mm

PST-30-6915 Ø 40 x 19 mm 20 ccm
PST-30-6916 Ø 61 x 30 mm 70 ccm
PST-30-6917 Ø 80 x 40 mm 140 ccm
PST-30-6918 Ø 116 x 50 mm 250 ccm
PST-30-6919 Ø 128 x 55 mm 350 ccm
PST-30-6920 Ø 147 x 65 mm 500 ccm
PST-30-6921 Ø 167 x 75 mm 900 ccm
PST-30-6922 Ø 187 x 85 mm 1.300 ccm

PST-30-6923 Ø 116 x 35 mm 200 ccm
PST-30-6924 Ø 128 x 38 mm 300 ccm
PST-30-6925 Ø 147 x 50 mm 400 ccm
PST-30-6926 Ø 167 x 45 mm 500 ccm
PST-30-6927 Ø 187 x 45 mm 800 ccm



PST-30-6934 Ø 100 x 20 mm
mit Deckel
with lid
con tapa
avec couvercle
con coperchio



PST-30-6929 100 ccm



PST-30-6935 Ø 96 x 20 mm
ohne Deckel
without lid
sin tapa
sans couvercle
senza coperchio



PST-30-6930 250 ccm
PST-30-6931 500 ccm
PST-30-6932 1.000 ccm
PST-30-6933 2.000 ccm



PST-30-6936
Petrischalendeckel
Lid for Petri Dishes
Tapa para cápsulas de Petri
Couvercle pour boîtes de Petri
Scodella rotonda

Mehrzweckschalen, Instrumententabletts

Universal Trays, Instrument Trays
Bandejas universales, Bandejas para instrumentos
Plateaux universaux, Plateaux pour instruments
Bacinelle universali, Bacinelle per strumenti

St 18/8

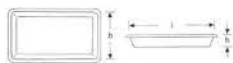

PST-30-6937 230 x 155 x 30 mm
PST-30-6938 300 x 175 x 30 mm
PST-30-6939 300 x 175 x 40 mm
PST-30-6940 350 x 240 x 40 mm
PST-30-6941 470 x 320 x 50 mm

PST-30-6942 210 x 160 x 10 mm
PST-30-6943 240 x 180 x 10 mm
PST-30-6944 310 x 150 x 10 mm
PST-30-6945 310 x 210 x 10 mm
PST-30-6946 350 x 240 x 10 mm
PST-30-6947 420 x 290 x 20 mm
PST-30-6948 400 x 300 x 12 mm



PST-30-6949 235 x 190 x 40 mm



PST-30-6950 Ø 220 mm x 70 mm

Standgefäße, Instrumentenkästen

Metal Jars, Instrument Boxes
Tarrs metálicos, Cajas para instrumentos
Réceptifs en métal, Boîtes pour instruments
Recipienti metallici, Scatole per strumenti



PST-30-6951 Ø 50 mm x 100 mm
PST-30-6952 Ø 50 mm x 130 mm
PST-30-6953 Ø 50 mm x 175 mm

PST-30-6954 Ø 75 mm x 100 mm
PST-30-6955 Ø 75 mm x 130 mm
PST-30-6956 Ø 75 mm x 175 mm

PST-30-6957 Ø 100 mm x 175 mm
PST-30-6958 Ø 100 mm x 200 mm

Deckel allein, geschlossen
Lid only, closed
Tapa suelta, cerrada
Couvercle seul, fermé
Coperchio solo, chiuso



mit Knopfdeckel
lid with knob
tapa con botón
avec couvercle à bouton
con coperchio a bottone



Deckel ohne Knopf
lid without knob
tapa sin botón
couvercle sans bouton
coperchio sen a bottone

PST-30-6967 165 x 85 x 35 mm
PST-30-6968 200 x 100 x 35 mm
PST-30-6969 200 x 100 x 50 mm
PST-30-6970 230 x 130 x 50 mm
PST-30-6971 260 x 150 x 50 mm
PST-30-6972 270 x 235 x 50 mm
PST-30-6973 300 x 200 x 50 mm
PST-30-6974 325 x 275 x 50 mm

PST-30-6975 165 x 85 x 35 mm
PST-30-6976 200 x 100 x 35 mm
200 x 100 x 50 mm
PST-30-6977 230 x 130 x 50 mm
PST-30-6978 260 x 150 x 50 mm
PST-30-6979 270 x 235 x 50 mm
PST-30-6980 270 x 235 x 50 mm
PST-30-6981 300 x 200 x 50 mm
PST-30-6982 325 x 275 x 30 mm
PST-30-6983 325 x 275 x 50 mm
PST-30-6984 420 x 80 x 40 mm
PST-30-6985 420 x 175 x 50 mm

Hygiene
Aufbewahrung

Hygiene, Storage
Higiene, Almacenaje
Hygiene, Stockage
Igiene, Magazzinaggio

30



Quality Instruments

Instrumentenkästen, Runde Metallboxen, Medizinbecher

Instrument Boxes, Round Metal Boxes, Medicine Cups
Cajas para instrumentos, Cajas metálicas redondas, Vasos medicinales
Boîtes pour instruments, Boîtes pour instruments, Gobelets
Scatole per strumenti, Scatole per strumenti, Bicchieri per medicina

St
18/8



PST-30-6986 205 x 105 x 40 mm



PST-30-6987 Ø 75 mm x 60 mm
PST-30-6988 Ø 75 mm x 75 mm
PST-30-6989 Ø 100 mm x 60 mm
PST-30-6990 Ø 100 mm x 100 mm
PST-30-6991 Ø 125 mm x 80 mm
PST-30-6992 Ø 125 mm x 125 mm
PST-30-6993 Ø 150 mm x 150 mm



PST-30-6994
Medizinlöffel
Medicine Spoon
Cuchara medicinal
Cuiller pour médicaments
Cucchiaino per medicina
20 ccm
innen graduert
graduated inside
graduado interiormente
graduè intérieurement
graduato all'interno
Cucchiaino per medicina



PST-30-6995
Tablettenschale
Tablet Tray
Bandejita para tabletas
Plateau pour comprimés
Bacinella per compresse
Ø 75 x 12 mm



PST-30-6996
25 ccm
innen graduert
graduated inside
graduado interiormente
graduè intérieurement
graduato all'interno



PST-30-6997
50 ccm



Becher, Nierenschale

Cups, Kidney Dishes
Tarro, Riñoneras
Récipients, Bassins réniformes
Recipienti, Bacinelle reniformi

St
18/8



PST-30-6998
Mundbecher
Metal Cup
Vaso metálico
Goblet en métal
Bicchiere metallico
Ø 90 x 90 mm



PST-30-6999
Zahnprothesenbecher
Denture Cup
Tarro para prótesis dental
Récipient à prothèses dentaires
Recipiente per protesi dentarie
Ø 75 x 50 mm



PST-30-7000
Sputumbecher
Sputum Cup
Escupidera
Crachoir
Sputacchiera
Ø 75 mm x 80 mm



PST-30-7005
Nierenschalen-Deckel
Lid for Kidney Dishes
Tapa para riñoneras
Couvercle pour bassins réniformes
Coperchio per bacinelle reniformi



PST-30-7002 170 x 100 x 35 mm
PST-30-7003 250 x 140 x 40 mm
PST-30-7004 275 x 150 x 45 mm



PST-30-7001
Bechereinsatz
Insert for Cup
Enjerto para escupidera
Inserto per sputacchiera
Ø 73 x 75 mm



Stechbecken, Dreieckschale, Plazentabecken

Bed Pans, Triangular Basins, Placenta Pan
Silletas, Cubetas triangulares, Cubeta para placenta
Bassins de lit, Bassins triangulaires, Bassin pour placenta
Padelle, Bacinelle triangolari, Bacinella per placenta

St
18/8



PST-30-7006 Ø 230 mm
PST-30-7007 Ø 300 mm



PST-30-7008
innen graduert bis 600 ccm, mit Griff
graduated inside up to 600 ccm, with handle
graduado interiormente hasta 600 ccm, con mango
graduè intérieurement jusqu'à 600 ccm, avec manche
graduato all'interno fino a 600 ccm, con manico



PST-30-7009
innen graduert bis 600 ccm
graduated inside up to 600 ccm
graduado interiormente hasta 600 ccm
graduè intérieurement jusqu'à 600 ccm
graduato all'interno fino a 600 ccm



PST-30-7010



Wattespender, Wattebehälter, Watteabfallbehälter

Cotton Dispensers, Waste Cotton Collector
Dispensadores de algodón, Recipiente para desperdicios
Distributeurs de coton, Porte-déchets
Distributori di cotone, Portarifiuti

Cr



PST-30-7011
Puderstreuendose
Powder Pot
Polvera
Distributeur de poudre
Distributore di polvere



Methot
PST-30-7012
Ø 50 x 75 mm
mit Deckel
with lid
con tapa
avec couvercle
con coperchio



Methot
PST-30-7013
Ø 50 x 75 mm



Methot
PST-30-7014
Ø 50 x 75 mm
ohne Deckel
without lid
sin tapa
sans couvercle
senza coperchio

Spritzenbänke

Syringe Racks
Dispositivo para jeringas
Support pour seringues
Supporto per siringhe

St
18/8



PST-30-7015
für 9 verschieden große Spritzen
for 9 syringes of different sizes
para 9 jeringas de diferentes tamaños
pour 9 seringues de différentes grandeurs
per 9 siringhe di diverse grandezze
Kunststoff
plastic
plástico

Cr

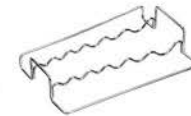

PST-30-7016
für 6 verschieden große Spritzen
for 6 syringes of different sizes
para 6 jeringas de diferentes tamaños
pour 6 seringues de différentes grandeurs
per 6 siringhe di diverse grandezze



Verschiedenes
Miscellaneous
Diversos artículos
Articles divers
Articoli diversi

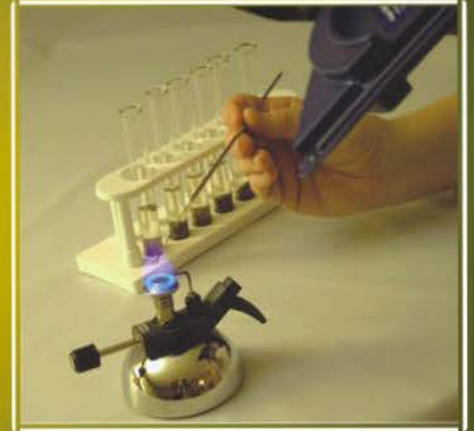

31

213 - 214

Asepsis
Asepsis
Asepsia
Asepsie
Asepsi



32

215- 216

Verschiedenes

Miscellaneous
Diversos artículos
Articles divers
Articoli diversi

31



Quality Instruments

Spirituslampen

Spirit Lamps
Lámparas de alcohol
Lampes à alcool
Lampade a spirito



PST-31-7101
flacher Docht
flat wick
mecha plano
mèche plate
lucignolo piatto



PST-31-7102
runder Docht
round wick
mecha rotondo
mèche ronde
lucignolo rotondo

Spirituslampen

Spirit Lamps
Lámparas de alcohol
Lampes à alcool
Lampade a spirito



PST-31-7105
runder Docht
round wick
mecha rotondo
mèche ronde
lucignolo rotondo



PST-31-7103
Ersatzdocht
Spare Wick
Mecha de repuesto
Mèche de rechange
Lucignolo di ricambio
Ø 4 mm



PST-31-7104
Ersatzdocht
Spare Wick
Mecha de repuesto
Mèche de rechange
Lucignolo di ricambio
12 mm
flach, per Meter
flat, per meter
plano, por metro
plate, par mètre
piatto, per metro



Abstreichösen, Präpariernadeln

Specimen Loops, Dissecting needles
Asas de espécimen, Agujas de disección
Anses de prélèvement, Aiguilles à dissection
Lacci al prelevio, Aghi per dissezione

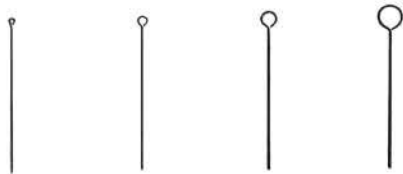

	Fig. 1 = Ø 1 mm	Fig. 2 = Ø 2 mm	Fig. 3 = Ø 3 mm	Fig. 4 = Ø 4 mm
40 x 0,5 mm	PST-31-7106	PST-31-7107	PST-31-7108	PST-31-7109
40 x 0,7 mm	PST-31-7106	PST-31-7107	PST-31-7108	PST-31-7109
60 x 0,5 mm	PST-31-7106	PST-31-7107	PST-31-7108	PST-31-7109
60 x 0,7 mm	PST-31-7106	PST-31-7107	PST-31-7108	PST-31-7109
100 x 0,5 mm	PST-31-7106	PST-31-7107	PST-31-7108	PST-31-7109
100 x 0,7 mm	PST-31-7106	PST-31-7107	PST-31-7108	PST-31-7109
40 x 0,5 mm	PST-31-7106	PST-31-7107	PST-31-7108	PST-31-7109



Abstreichösen, Präpariernadeln

Specimen Loops, Dissecting needles
Asas de espécimen, Agujas de disección
Anses de prélèvement, Aiguilles à dissection
Lacci al prelevio, Aghi per dissezione

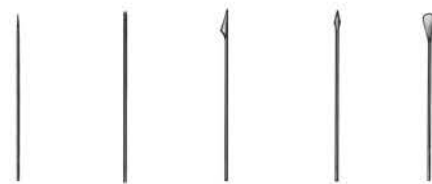

	Fig. 1	Fig. 2	Fig. 3	Fig. 4	Fig. 5
40 x 0,5 mm	PST-31-7110	PST-31-7111	PST-31-7112	PST-31-7113	PST-31-7114
40 x 0,5 mm	PST-31-7110	PST-31-7111	PST-31-7112	PST-31-7113	PST-31-7114



Verschiedenes

Miscellaneous
Diversos artículos
Articles divers
Articoli diversi

31



Quality Instruments

Präpariernadelhalter

Holder for dissecting needles
Porta-agujas de disección
Porte-aiguilles à dissection
Portaghi per dissezione



Kolle

PST-31-7115
24 cm / 9 4/8"

PST-31-7116
24 cm / 9 4/8"

Kunststoff / Aluminium
plastic / Aluminium
plástico / Aluminium
matière plastique / Aluminium
plastica / Aluminium



Präpariernadelhalter

Holder for dissecting needles
Porta-agujas de disección
Porte-aiguilles à dissection
Portaghi per dissezione



Kolle

PST-31-7117
24 cm / 9 4/8"

Kolle
PST-31-7118
16 cm / 6 2/8"

Kunststoff / Stahl
plastic / steel
plástico / acero
matière plastique / acier
plastica / acciaio



Abfalleimer, Abfallzangen

Waste Bucket, Waste Forceps
Cobo para desechos, Pinzas para desechos
Seaux pour déchets, Pincas pour déchets
Secchi per rifiuti, Pinze per rifiuti

St
18/8



PST-31-7120

PST-31-7119
Inhalt
capacity
capacidad
capacité
capacità
15 l



Abfalleimer, Abfallzangen

Waste Bucket, Waste Forceps
Cobo para desechos, Pinzas para desechos
Seaux pour déchets, Pincas pour déchets
Secchi per rifiuti, Pinze per rifiuti



Martin

PST-31-7121
58 cm / 22 7/8"



Sauerbruch

PST-31-7122
55 cm / 21 5/8"



Asepsis

Asepsis
Asepsia
Asepsie
Asepsi

32



Quality Instruments

Nagelscheren, Nagelzangen

Nail Scissors
Tijeras para uñas
Ciseaux à ongles
Forbici per unghie



PST-32-7201
10.5 cm / 4 1/8"



PST-32-7202
14 cm / 5 4/8"



PST-32-7203
Nagelschere und Nagelfeile an Kette
nail scissors and nail file with chain
tijeras y lima para uñas con cadena
ciseaux à ongles et lime à ongles avec
forbici e lima per unghie con catena

Nagelscheren, Nagelzangen

Nail Scissors
Tijeras para uñas
Ciseaux à ongles
Forbici per unghie



PST-32-7204
14 cm / 5 4/8"
PST-32-7205
16 cm / 6 2/8"



Turnbull
PST-32-7206
12 cm / 4 6/8"
PST-32-7207
13 cm / 5 1/8"



PST-32-7208
13 cm / 5 1/8"



PST-32-7209
12 cm / 4 6/8"



Nageleckenzangen, Nagelhautzangen, Hautscheren, Nagelfeilen

Nail Nippers, Cuticle Nippers, Cuticle Scissors, Nail Files
Pinzas para cortar uñas, Pinzas cuticulares, Tijeras cuticulares, Limas para uñas
Pinces pour couper ongles, Pinces à envies, Ciseaux à envies, Limes à ongles
Tronchesine per unghie, Tronchesine per pelle, Forbici per pelle, Lime per unghie



PST-32-7210 - 7212
gerade Schneiden
straight cutting edges
hojas cortantes rectas
lames tranchantes droites
parte tagliente diritta
PST-32-7210 10 cm / 3 7/8"
PST-32-7211 13 cm / 5 1/8"
PST-32-7212 15 cm / 5 7/8"

PST-32-7213 - 7214
PST-32-7213 11 cm / 4 3/8"
PST-32-7214 13 cm / 5 1/8"

PST-32-7215
11 cm / 4 3/8"
feines Modell
delicate pattern
modelo delicado
modèle fin
modello fino
PST-32-7216 - PST-32-7217
PST-32-7216 10.5 cm / 4 1/8"
PST-32-7217 11.5 cm / 4 4/8"

Nageleckenzangen, Nagelhautzangen, Hautscheren, Nagelfeilen

Nail Nippers, Cuticle Nippers, Cuticle Scissors, Nail Files
Pinzas para cortar uñas, Pinzas cuticulares, Tijeras cuticulares, Limas para uñas
Pinces pour couper ongles, Pinces à envies, Ciseaux à envies, Limes à ongles
Tronchesine per unghie, Tronchesine per pelle, Forbici per pelle, Lime per unghie



PST-32-7218 - 7219
feines Modell
delicate pattern
modelo delicado
modèle fin
modello fino

PST-32-7220
10 cm / 3 7/8"

PST-32-7221
11 cm / 4 3/8"

PST-32-7218 10.5 cm / 4 1/8"
PST-32-7219 11.5 cm / 4 4/8"

PST-32-7222
16 cm / 6 2/8"

Saphirbelag
sapphire coating
recubrimiento de zafiro
couche en saphir
rivestimento in zaffiro



Asepsis

Asepsis
Asepsia
Asepsie
Asepsi

32



Quality Instruments

Eye Brow Tweezers

All Tweezers are available in different types of finishings



PST-32-7223
Eye Brow Tweezer.
Sizes: 3.5" / 4"

PST-32-7224

PST-32-7225

PST-32-7226



PST-32-7227

PST-32-7228

PST-32-7229

PST-32-7230



Eye Brow Tweezers

All Tweezers are available in different types of finishings



PST-32-7231

PST-32-7232

PST-32-7233

PST-32-7234



PST-32-7235

PST-32-7236

PST-32-7237



Fancy Scissors

All Scissors are available in Half Gold, Full Gold, Satin Finish & Mirror Finish.



PST-32-7238
Fancy Cuticle Scissors
(Str & Cvd) Size: 3.5"

PST-32-7239
Fancy Cuticle Scissors
Printed (Str & Cvd) Size: 3.5"

PST-32-7240
Fancy Cuticle Scissors
Printed (Str & Cvd) Size: 3.5"



PST-32-7241
Fancy Cuticle Scissors
Printed (Str & Cvd) Size: 3.5"

PST-32-7242
Stork Scissors
Sizes: 3.5" / 4"



Fancy Scissors

All Scissors are available in Half Gold, Full Gold, Satin Finish & Mirror Finish.



PST-32-7243
Hen Scissors
Sizes: 3.5" / 4"

PST-32-7244
Butterfly Scissors
Sizes: 3.5" / 4"

PST-32-7245
Fish Scissors
Sizes: 3.5" / 4"



PST-32-7246
Printed Scissors
Sizes: 3.5" / 4"

PST-32-7247
Duck Scissors
Sizes: 3.5" / 4"





Alphabetical Index

A

Abdominal Retractor.....	70,71,72	Bainbridge, Multi purpose Vascular Clamp.....	129	Bone Wire.....	98	Castroviejo, Micro Scissors	17
Abdominal Spatula	64	Bakes, Gall Duct Dilator.....	155	Bone Wire, I.M.F-	98	Castroviejo-Epker, Caliper.....	168
Adams, Napkin Holder.....	186	Balfour, Abdominal Retractor	71,72	Bonney, Dissecting Forceps	27,32	Castroviejo-Fino, Micro Needle Holder.....	81
Adapter, Irrigation-	175	Balfour, Central Blade.....	72	Bosworth, Nasal Forceps	182	Catcher, Ligature.....	90,138
Adenoid Curette	185	Balfour, Mod. USA, Abdominal Retractor	72	Bowl, Stainless Steel.....	211	Catheter Clamp	127
Adlerkreutz, Dissecting Forceps	30	Balfour, Mod. USA, Fenestrated Blade	72	Bowman, Probe.....	168	Catheter Introducing Forceps.....	79
Adson, Dissecting and Ligature Forceps.....	39	Balfour-Baby, Abdominal Retractor	71	Box, Drill Collecting.....	209	Catheter, Ear.....	173
Adson, Dissecting Forceps.....	28,31	Balfour-Standard, Abdominal Retractor	72	Box, Instrument.....	211,212	Catheter, Metal, female.....	158
Adson, Dressing Forceps	26, 28	Ballenger, Septum Gouge.....	181	Box, interior.....	209	Cawood-Minnesota, Cheek Retractor	188
Adson, Dura Hook	143	Ballenger, Swivel Knife	180	Box, round, Metal.....	212	Central Blade.....	67, 70,71, 72,153,157
Adson, Elevator.....	109	Ballengler-Hajek, Septum Elevator	180	Boys-Allis, Intestinal & Tissue		Chain, Retractor.....	196
Adson, Needle Holder	82	Band, Head-	74	Grasping Forceps	148	Champy, TMJ-Spreader	195
Adson, Suction Cannula.....	76	Bandage Scissors	93,94	Bozemann, Knot Tier	90	Champy-OSU, Bone Biopsy Instrument.....	103
Adson, Wound Spreaders		Barbara, Micro Ear Hook	170	Bozemann, Needle Holder.....	86	Channel Retractor	191,202
self-retaining	53,66,68	Barbara, Micro Ear Needle	170	Bozemann, Sponge Forceps.....	49	Chaput, Haemostatic Forceps	37
Adson-Baby, Dissecting and Ligature Forceps.....	41	Baron-Schuknecht, Suction Tube	76	Braeker, Plaster.....	94	Charrière, Amputation Saw.....	95
Adson-Brown, Dissecting Forceps	28,31	Barraquer, Cilia Forceps.....	34	Brauer, Plaster.....	91	Charrière, Spare Saw Blade	95
Aiach, Columella Suturing Forceps.....	184	Barraquer, Micro Needle Holder.....	81,85	Brain Spatula.....	142	Cheattle, Sterilizing Forceps.....	209
Alan-Parks, Rectal Spreader	153	Barraquer-Troutman, Micro Needle		Brand, Tendon Tunnelling Forceps	112	Cheek Retractor	188
Alar Hooklet.....	183,184	Holder.....	81	Braun, Uterine Depressor	162	Cheron, Dressing Forceps.....	49
Alderdyce, Dissector, double-ended.....	110	Basin, Triangular-	212	Braun, Uterine Tenaculum Forceps	162,163		
Alexander, Chisel.....	99	Beacham, Amniotome.....	162	Braun-Stadler, Episiotomy Scissors	15	Childe, Approximation Forceps	90
Alexander, Gouge	99	Beckman-Adson, Wound Spreaders		Breaker, Skull-	99	Chin Holder	202
Alexander, Periosteal Elevator.....	108	self-retaining	69	Brom, Vein Hook	53	Chin Retractor.....	191
Alexander, Uterine Biopsy Forceps	165	Beckman-Eaton, Wound Spreaders		Bronchus Clamp	123,133	Chisel	99,100,102,181,182,197
Allen, Intestinal Clamp	150	self-retaining	69	Brown, Needle Holder.....	82	Chisel Blade	100
Allis, Intestinal and Tissue		Beckmann, Adenoid Curette	185	Brünings, Exchangeable Tip	200	Chisel Handle	100
Grasping Forceps	148	Beckmann, Wound Spreaders, self-retaining.....	68	Brünings, Interchangeable Tube.....	199	Chisel, Bone	99
Allis-Adair, Intestinal and Tissue Grasping		Bed Pan	212	Brünings, Laryngeal Tube	199	Chisel, Rhinoplastic	182
Forceps	148	Beebe, Wire Cutting Scissors	05	Brünings, Septum Forceps	177	Chisel, Septum-	181
Allis-Baby, Intestinal and Tissue Grasping		Beer, Cilia Forceps	34	Brünings, Septum Knife.....	180	Cilia Forceps.....	34
Forceps	148	Bellucci, Micro Ear Scissors	169	Brünings, Tongue Spatula	189	Cinelli, Chisel	182
Allison, Lung Spatula	123	Bengolea, Haemostatic Forceps	40	Brünings, Tonsil Knife.....	198	Cinelli, Nasal Scissors	11
Alm, Wound Spreaders, self-retaining.....	65	Bennett, Bone Lever	111	Brünings, Tonsil Snare	199	Circular Cut Knife.....	170
Amniotome	162	Bergmann, Plaster Shears	87	Brunner, Retractor.....	60	Circumcision Instrument	158
Amputation Knife	04	Bergmann, Sponge Forceps	50	Brunner, Sigmoid Anastomosis Forceps	152	Citelli, Mastoid Rongeur.....	173
Amputation Retractor	115	Bernhard, Towel Clamp	48	Bruns, Bone Curette	105	Clamp, Anastomosis-	129,133,135,
Amputation Saw.....	95	Bethune, Rib Shear	120	Bruns, Plaster Scissors	93,94	136,137,137	
Anaestophon, Stethoscope	73	Beyer, Bone Rongeur	116	Buck, Ear Curette.....	174	Clamp, Aneurysm-	134
Anastomosis Clamp	129,133	Beyer, Mastoid Rongeur	173	Buck, Foreign Body Lever.....	173	Clamp, Aorta-Anastomosis-.....	131
Anderson-Adson, Wound Spreaders		Biemer, Micro scissors for veins	18	Buck, Percussion Hammer	73	Clamp, Aortic Aneurysm-	130
self-retaining	66	Biemer, Vessel Clip.....	35	Buck, Stitch Scissors.....	19	Clamp, Auricle-	132
Aneurysm Clamp	134	Bier, Amputation Saw	95	Buck, Trolley	214	Clamp, Bile Duct-	44,45,46
Angled Scissors.....	24	Bier, Spare Saw Blade	95	Bucket, Waste.....	214	Clamp, Bronchus-	123,133
Anterior Border Stripper	196	Bile Duct Clamp.....	44,45,46	Bucket Trolley	214	Clamp, Bulldog-.....	35,36,124,128
Antrum Curette	185	Billeau, Ear Loop	174	Buckley, Wound Spreaders, self-retaining	65	Clamp, Bulldog Clamp.....	35,36, 124,128
Antrum Irrigation Cannula	185	Bircher-Ganske, Cartilage Seizing Forceps	113	Bunnell, Tendon Passer	112	Clamp, Carotid-.....	124,137
Antrum Punch	178,179	Bishop, Lip and Cheek Retractor.....	188	Bunnell, Tendon Stripper	112	Clamp, Carotid Shunt-	126
Antrum Rasp.....	182	Bit, Screwdriver-	96	Burford, Rib Retractor	121	Clamp, Catheter-	127
Anuscope	153	Bladder Neck Spreader	157	Burr	186	Clamp, Coarctation-	128
Aorta Retractor.....	61	Bladder Retractor.....	157	Burr, spherical	96	Clamp, Iliac.....	137
Aorta-Anastomosis Clamp.....	131	Blade Holder / Blade Breaker	02	Busch, Umbilical Scissors.....	16	Clamp, Intestinal & Pylorus-	150
Aortic Aneurysm Clamp.....	130	Blade only, Specula.....	161	Button ended Tip.....	175	Clamp, Intestinal & Pylorus-	150
Applying Forceps.....	128	Blade Osteotome.....	203	Byrd, Suction Tube.....	78	Clamp, Kidney Pedicle	44,45
Applying/Removal Forceps.....	140	Blade, Chisel-	100	C		Clamp, Multi purpose Vascular-	125, 129,130,
Approximation Forceps	90	Blade, Fenestrated	72	Caliper	73, 168, 207,208	134,135,137	
Aquila, Hysterectomy Scissors	25	Blade, Gouge-	100	Caliper, Vascular Measuring.....	127	Clamp, Neonatal Vascular-	139
Arch Bar.....	192	Blade, Laryngoscope-	79	Calne, Forceps for Vena Cava.....	131	Clamp, Pediatric Vascular-	136
Arm and Leg Rest.....	214	Blade, Lateral.....	70,71,122,124	Cane	214	Clamp, Penis-	158
Arruga, Micro Needle Holder	81	153,157		Cannula	78	Clamp, Peripheral Vascular-	125,126
Arruga, Needle Holder	81,84	Blade, Saw-	03	Cannula, Antrum Irrigation-	185	127,129	
Asch, Septum Straightening Forceps.....	184	Blade, Scalpel, non-sterile	03	Cannula, Insufflation-	78	Clamp, Profunda-	125
Aston, Face-lift Scissors	11	Blade, Scalpel, sterile	03	Cannula, Micro Suction-	76	Clamp, Ramus-	197,202
Atraumatic Dressing Forceps	27,29	Blake, Gall Stone Forceps	156	Cannula, Suction-	76	Clamp, Scalp-	204
Atraumatic Micro Forceps	33	Blake, Uterine Scoop.....	166	Cannula, Vein-	78	Clamp, Tangential Occlusion-	132
Atrium Retractor	63	Blohmke, Tonsil Grasping Forceps.....	199	Cannula, Vessel Irrigation.....	78	Clamp, Towel-	47,48
Attic Dissector	171	Blood Pressure Manometer.....	75	Cap, Protection-	178	Clamp, Umbilical Cord-	167
Aufricht, Glabella Rasp.....	183	Blount, Knee Retractor	111	Caplan, Septum Forceps	178	Clamp, Uterine-	167
Aufricht, Nasal Retractor.....	183,184	Blumenthal, Bone Rongeur	116	Capsule Forceps.....	157	Clamp, Vaginal.....	46
Auricle Clamp	132	Böhler, Bone Cutting Forceps	118	Carotid Clamp.....	124,137	Clamp, Vascular-	42, 132
Austin, Attic Dissector	171	Böhler, Bone Rongeur	116	Carotid Shunt Clamp	126	Cleft Palate Dissector	198
Autopsy Knife	01	Bone Biopsy Instrument.....	103	Carpenter, Tonsil Knife / Enucleator	198	Cleft Palate Elevator	198
Auvard, Vaginal Speculum.....	161	Bone Chisel	99	Carriage, Oxygen Cylinder.....	213	Cleft Palate Hooklet.....	198
Awl	206	Bone Contouring Forceps	204,206	Carroll, Tendon Holding Forceps	112	Cleft Palate Needle	198
Awl, Maxillary-	203	Bone Curette	105,106,107	Carrying Rack for Bed Pans	214	Cleft Palate Osteotome	207
Awl, Zygomatic Arch-	203	Bone Curette, double-ended.....	106,107	Carrying Rack for Urinals	214	Cleft Palate Periosteal Elevator	198
Ayre, Conization Knife	164	Bone Cutting Forceps	118,119,205	Cartilage Crusher.....	182	Cleft Palate Rasapatory.....	180,198
B		Bone File	108,109,182,183	Cartilage Knife	01	Cleveland, Bone Cutting Forceps.....	118
Babcock, Intestinal and Tissue		Bone Holding Forceps.....	112,113,115	Cartilage Seizing Forceps	113	Cleveland, Bone Rongeur	115,116
Grasping Forceps	148	193,194,196, 205		Case, Needle-	209	Clip Applying Forceps	35, 90, 140
Backhaus, Towel Clamp	47,48	Bone Hook	207	Case, Storage-	209	Clip, Scalp-	140
Bailey, Rib Contractor	123	Bone Hooklet	51	Castañeda, Neonatal Vascular Clamp.....	139	Clip, Vessel-	35
Bailey-Baby, Rib Contractor.....	123	Bone Lever	110,111	Castañeda, Neonatal Vascular Clamp.....	139	Cloward, Blades, (pair)	68
Bailey-Gibbon, Rib Contractor	123	Bone Rasp.....	102	Castañeda, Rib Retractor	121	Cloward, Lamina Spreader.....	143
		Bone Shear.....	120	Castroviejo, Blade Holder / Blade Breaker	02	Cloward, Wound Spreaders	
				Castroviejo, Caliper.....	168	self-retaining	68

Alphabetical Index



Coakley, Antrum Curette.....	185	Crile-Murray, Needle Holder	82	Delicate Dissecting Scissors.....	11-12, 22-23	Durante, Dissecting Forceps	31
Coarctation Clamp.....	128	Crile-Rankin, Haemostatic Forceps	39	Denhart, Mouth Gag	186	Duval, Intestinal & Tissue Grasping	
Cogswell, Suction Tube	78	Crile-Wood, Needle Holder	82, 84, 85	Denture Cup	212	Forceps	148,149
Collector, Waste Cotton-	212	Crusher, Cartilage.....	182	Depressor, Tongue-	187-188	E	
Collier, Needle Holder.....	89	Crutch.....	214	Depressor, Uterine.....	162	Ear Catheter	862
Collin, Abdominal Retractor	70	Crutchfield, Skull Traction Tong	140	Derf, Needle Holder.....	82, 85	Ear Curette	866
Collin, Dressing Forceps.....	49	Cuff, Velcro-	75	Dermal Punch.....	147	Ear Forceps	863
Collin, Mallet	103	Cup, Denture-.....	212	Dermatome.....	5	Ear Hooklet	867-868
Collin, Organ Grasping Forceps	37	Cup, Insert for.....	212	Derma, Anastomosis Clamp.....	136	Ear Loop.....	867
Collin, Scalpel Handle	2	Cup, Medicine-	212	Desjardins, Bile Duct Clamp.....	45	Ear Polypus Forceps	863, 864
Collin, Tongue Holding Forceps.....	189	Cup, Metal-	212	Desjardins, Gall Stone Forceps	156	Ear Probe	328
Collin, Tumor Grasping Forceps	37	Cup, Sputum	212	Desmarres, Saddle Hook	51	Ear Scoop.....	867, 869
Collin, Umbilical Cord Clamp	167	Curette, Adenoid-	185	Dieffenbach, Bulldog Clamp.....	35	Ear Scoop/Hook	867
Collin, Uterine Seizing Forceps	164	Curette, Antrum-.....	185	Dilator, Aortic Clamp.....	125	Ear Specula Storage Rack	857
Collin, Vaginal Speculum	159	Curette, Bone-	105-106, 107	Diethrich, Bulldog Clamp	35	Ear Specula, Set	856-857
Collin-Hartmann, Retractor.....	64	Curette, Bone-, double-ended.....	106-107	Diethrich, Vascular Scissors	13	Ear Speculum.....	856-857
Columella Forceps.....	184	Curette, double ended	185	Diethrich-Salyer, Dissecting Scissors	13	Ear Syringe.....	872-873
Columella Suturing Forceps.....	184	Curette, Ear-	174	Dilator, Gall Duct-	155	Easycut, Spare part Set	498
Combi-Flat Nose Plier.....	97	Curette, Lupus-	147	Dilator, Tracheal-	145	Easycut, Wire cutter	498
Combi-Wire Twisting Forceps	97	Curette, Micro-	171	Dilator, Uterine-	161,162	Ecklin, Bone Rongeur	586
Comedone Extractor	147	Curette, Suction.....	164,166	Dilator, Uterine-, Set	161,162	Eckelt, Extra Oral Retractor	933-934
Conductor, Ligature-	90	Curette, Uterine-	166	Dilator, Vascular -	138	Eckelt, Plate-pulling Instrument	952
Condylar Repositioning Instrument.....	192	Curette, Uterine Biopsy.....	164	Dingmann, Cartilage Seizing Forceps	113	Eicken-Killian, Antrum Irrigation Cannula	914
Cone	158	Cusco, Vaginal Speculum.....	159	Dingmann, Mouth Gag	188	Eiselsberg, Stitch Scissors	78
Cone, Cranial Punch	140	Cushing, Dissecting Forceps	30	Dingmann, Tongue Depressor	188	Elevator.....	109,186, 192,202, 208
Cone, Loading-.....	154	Cushing, Dressing Forceps	27,28	Dingmann, Zygoma Elevator	193	Elevator, Cleft Palate-	198
Conical Tip	175	Cushing, Laminectomy Rongeur.....	145	Dingmann-Wilk, Retractor	193	Elevator, Cleft Palate Periosteal-	198
Conization Knife.....	164	Cushing, Nerve Hook	142	Director, Grooved-	92	Elevator, Micro-.....	109
Contractor, Rib.....	123	Cushing, Retractor.....	52	Disc, Protecting-	175	Elevator, Micro Ear Periosteal-	171, 174
Converse, Alar Hooklet.....	184	Cushing, Saddle Hook.....	53	Dish, flat	211	Elevator, Periosteal-.....	107-108, 181, 191,
Converse, Nasal Retractor	184	Cushing-Taylor, Dressing Forceps	28	Dish, Kidney-	212	Elevator.....	192, 195, 196, 202,206, 208
Converse, Nasal Scissors.....	15	Cutter, Plate-	98	Dish, Petri-	211	Elevator, Phalangeal-	109
Converse, Rhinoplastic Knife.....	180	Cutter, Wire-, front action.....	98	Disimpaction Forceps	193, 207	Elevator, Ramus Periosteal-	205
Cooley, Anastomosis Clamp	137	Cuzzi, Placenta Scoop	167	Dispenser, Cotton-	212	Elevator, Septum-.....	180
Cooley, Aortic Clamp.....	130	Czerny, Rectal Speculum	153	Disposable Scalpel	4	Elevator, TMJ-.....	194
Cooley, Atrium Retractor	63	Czerny, Uterine Tenaculum Forceps.....	163	Dissecting and Ligature Forceps	37, 38	Elevator, Tonsil-.....	198
Cooley, Carotid Clamp	137	D		Dissecting Forceps	41-44, 45	Elevator, Zygoma-	193
Cooley, Catheter Clamp	127	Dahlgren, Cranial Rongeur.....	140	Dissecting Forceps	27-28, 29,	Elsässer, Nephrostomy Forceps.....	155
Cooley, Iliac Clamp.....	137	Dale, Peripheral Vascular Clamp	125	Dissecting Forceps	31-32	Emmett, Fistula Hook.....	164
Cooley, Multi purpose Vascular Clamp	137	Damper	172	Dissecting Knife.....	1	Endocervical Speculum.....	161
Cooley, Pediatric Vascular Clamp	136	Dandy, Haemostatic Forceps	39	Dissecting Needle	213	Enterotomy Scissors	19
Cooley, Rib Retractor	120	Dandy-Mosquito, Haemostatic Forceps	39	Dissector	109	Enucleation Scissors.....	17
Cooley, Suction Tube	77	Dardiik, Multi purpose Vascular Clamp	125	Dissector, Attic-	171	Enucleator, Goitre	146
Cooley, Vascular Forceps	136	Dartigues, Uterine Seizing Forceps.....	164	Dissector, Cleft Palate-	198	Episiotomy Scissors.....	15
Cooley-Beck, Anastomosis Clamp.....	137	d'Assumpção, Face-lift Forceps	147	Dissector, double ended-.....	101	Epker, Osteotome	195
Cooley-Derra, Anastomosis Clamp	137	Dautrey-Munro, Osteotome.....	195	Dissector, Dura-	141	Epker-Bauer, Osteotome.....	195
Cooper, Ligature Needle.....	89	Davidson, Scapula Retractor.....	60	Dissector, Micro-	92, 171	Erich, Arch Bar	192
Cordes, Exchangeable Tip.....	200	Davis, Dura Dissector.....	141	Dissector, Vascular-	138	Esmarch, Plaster Knife	94
Coronary Scissors	13,14	Davis-Boyle, Frame for Mouth Gag	187	Dissector/Retractor, Tonsil-	198	Esmarch, Plaster Shears	93
Corwin, Wire Twisting Forceps.....	97	Davis-Boyle, Mouth Gag	187	Dolwick, Ligature Forceps	194	Ethmoid Bone Forceps.....	177-178
Coryllos, Retractor	60	Davis-Boyle, Tongue Depressor	187	Dolwick, Resection Knife for TMJ	194	Eves, Tonsil Snare	199
Cottle, Alar Hooklet	184	Day, Ear Hooklet	174	Dolwick, TMJ Condyle Hook	194	Exchangeable Tip	200
Cottle, Cartilage Crusher	182	De Bakey, Anastomosis Clamp	133, 135	Dolwick, TMJ Disc Forceps.....	194	Exploring Hook.....	171
Cottle, Columella Forceps	184	De Bakey, Angled Scissors.....	24	Dolwick, TMJ Disc Scissors	194	External Progeny Retractor	191,192
Cottle, Guide Support	182	De Bakey, Aortic Aneurysm Clamp	130	Dolwick, TMJ-Elevator	194	Extra Oral Retractor.....	189
Cottle, Mallet	103	De Bakey, Aortic Clamp	127, 130, 131	Dolwick, TMJ-Forceps.....	195	Extractor, Comedone.....	147
Cottle, Nasal Hook	183	De Bakey, Applying Forceps	128	Dolwick, TMJ-Rasp.....	194	Eyelite forceps	208
Cottle, Nasal Rasp	182	De Bakey, Atraumatic Dressing Forceps	29	Dolwick, TMJ-Spreader	194	F	
Cottle, Nasal Retractor.....	184	De Bakey, Bulldog Clamp.....	128	Donovan, Orbital Rim Retractor	193	Face-lift Forceps	37, 147
Cottle, Nasal Scissors	15	De Bakey, Lateral Blade	122	Double ended Curette	185	Face-lift Hooklet	147
Cottle, Nasal Speculum	176	De Bakey, Ligature Forceps	129, 131-131	Double ended, Dissector	110	Face-lift Scissors.....	11, 12, 19, 23, 147
Cottle, Osteotome.....	181	De Bakey, Multi purpose		Douglas, Cilia Forceps	34	Farabeuf, Bone Holding Forceps	114
Cottle, Periosteal Elevator	181	Vascular Clamp.....	130, 134, 135	Doyen, Grooved Director.....	92	Farabeuf, Periosteal Elevator	107
Cottle, Rhinoplastic Knife	180	De Bakey, Needle Holder.....	85	Doyen, Gynecological Scissors	9	Farrell, Cotton Applicator	92
Cottle, Saddle Hook.....	184	De Bakey, Pediatric Vascular Clamp	136	Doyen, Intestinal Clamp.....	149, 151	Farrior, Ear Speculum.....	171
Cottle, Septum Elevator	180,181	De Bakey, Peripheral Vascular Clamp	129	Doyen, Mallet.....	103	Fasciotomy Knife	138
Cottle, Skin Grasping Forceps.....	184	De Bakey, Retractor, only	122	Doyen, Myoma Screw.....	164	Fasciotomy Spatula	138
Cottle, T-Handle	182	De Bakey, Rib Retractor	122	Doyen, Retractor	59	Fat Spreader	65
Cottle-Kazanjian, Bone Cutting Forceps.....	118	De Bakey, Vascular Dilator.....	138	Doyen, Rib Respiratory	108	Faulkner, Curette double ended	185
Cottle-Neivert, Alar Hooklet	184	De Bakey, Vascular Forceps	128	Doyen, Tongue Spatu	9	Faure, Peritoneum Forceps.....	47
Cottle-Walsham,SeptumStraightening		De Bakey, Vascular Scissors	14	Doyen, Vaginal Speculum.....	160	Faure, Uterine Biopsy Forceps	165
Forceps	184	De Bakey-Bahnsn, Aneurysm Clamp	134	Doyen-Baby, Intestinal Clamp.....	149, 151	Favaloro, Vascular Scissors.....	14
Cotton Applicator	92	De Bakey-Beck, Anastomosis Clamp.....	136	Doyen-Stille, Retractor.....	58	Fehland, Sigmoid Anastomosis Forceps	153
Cotton Dispenser	212	De Bakey-Diethrich, Bulldog Clamp	35	Dressing Forceps.....	26-27,28, 29, 31- 32,49	Feilchenfeld, Splinter Forceps	33
Coupland, Suction Handle.....	77	De Bakey-Mosquito, Haemostatic		Dressing Sterilizing Drum.....	209	Fenestrated Blade	72
Coupland, Suction Tip.....	77	Forceps	124, 135	Drill Collecting Box.....	209	Ferguson, Bone Holding Forceps	113
Coupling Piece.....	166	De Bakey-Pean, Haemostatic Forceps.....	135	Drill Point.....	140	Ferguson, Suction Tube	76
Crafoord, Dissecting & Ligature Forceps	42	De Bakey-Rankin, Haemostatic Forceps.....	124	Drill, Hand-	96	Ferris-Smith-Kerrison, Sphenoid	
Crafoord, Vascular Clamp	42	De Bakey-Satinsky, Bulldog Clamp.....	124	Drum, Dressing Sterilizing.....	209	Bone Punch.....	179
Crafoord-Sellers, Vascular Clamp	42	De Martel, Wire Saw Guide.....	140	Dunhill, Haemostatic Forceps.....	38	Fiber Optic Light Carrier	153, 179
Cranial Punch	140	De Vilbiss, Cranial Rongeur	140	Dunn-Dautrey, Osteotome.....	195	File, Bone-	108-109, 182-183
Cranial Rongeur	140	Dean, Tonsil Scissors	15, 25	Duplay, Uterine Tenaculum Forceps	162	Finger Protector	186
Crile, Haemostatic Forceps.....	38	Deaver, Operating Scissors	7	Duplex, Stethoscope.....	73	Finochietto (modif.), Rib Retractor.....	121
Crile, Needle Holder	83	Deaver, Retractor	62	Duplex-Baby, Stethoscope.....	73	Finochietto, Baby, Rib Retractor	120, 122
Crile, Nerve Hooklet	138	Dejerine, Percussion Hammer	73	Dura Dissector	141	Finochietto, Dissecting & Ligature Forceps	44



Alphabetical Index

Finochietto, Infant, Rib Retractor.....120	Forceps, Septum Straightening.....184	Glasses, Magnifying.....75	Hartmann, Ear Hooklet174
Finochietto, Needle Holder.....83, 86	Forceps, Sigmoid Anastomosis-152	Glover, Anastomosis Clamp133	Hartmann, Ear Polypus Forceps.....173
Finochietto, Rib Retractor212, 122	Forceps, Sinus-49	Glover, Bulldog Clamp124, 128	Hartmann, Ear Specula, Set171
Finsen, Wound Spreaders, self-retaining65	Forceps, Skin Grasping-184	Glover, Multi purpose Vascular Clamp.....135	Hartmann, Ear Speculum.....171
Finsen-Martin, Wound Spreaders, self-retaining65	Forceps, Splinter.....33, 34	Gluck, Rib Shear.....120	Hartmann, Haemostatic Forceps37
Fisch, Micro Dissector171	Forceps, Sponge-49-50	Goelet, Retractor65	Hartmann, Nasal Cutting Forceps178
Fischer, Tendon Stripper112	Forceps, Spreading.....207	Goitre Enucleator146	Hartmann, Nasal Polypus Forceps.....177
Fisher, Tonsil Knife.....198	Forceps, Sterilizing.....209	Goldman-Fox, Gum Scissors16	Hartmann, Tongue Depressor.....188
Fistula Hook164	Forceps, Tangential-44	Goldmann-Fox, Ligature Scissors24	Hartmann, Tonsil Punch.....199
Fistula Probe92	Forceps, Tendon Holding-112	Goldsmith (Thudichum), Nasal Speculum.....175	Hartmann, Tuning Fork172
Flap Knife170	Forceps, Tendon Interlacing-112	Goodell, Uterine Dilator161	Hartmann-Halle, Nasal Speculum.....175
Flat Dish211	Forceps, Tendon Tunnelling-112	Gorney, Face-lift Scissors11, 23, 147	Hartmann-Herzfeld, Ear Polypus Forceps.....173
Flat Nose Plier97, 204	Forceps, TMJ-195	Gosset, Abdominal Retractor71	Hartmann-Hoffmann, Ear Polypus Forceps.....173
Flexible Tube175	Forceps, TMJ Disc.....194	Gosset-Baby, Abdominal Retractor71	Hartmann-Wullstein, Ear Polypus Forceps.....173
Fomon, Alar Hooklet.....183-184	Forceps, Tongue Holding.....189	Gouge99-100, 101, 102	Hayes, Sigmoid Anastomosis Forceps152
Fomon, Bone File183	Forceps, Tonsil-199	Gouge Blade100	Head Band74
Fomon, Chisel.....181	Forceps, Tonsil Grasping-199	Gouge, Micro Hooklet51	Head Mirror74
Fomon, Nasal Rasp183	Forceps, Tubal-32	Gouge, Septum-181	Heaney, Hysterectomy Forceps46
Fomon, Nasal Scissors.....11, 15	Forceps, Tumor Grasping.....37, 145	Gouge, Spongiosa-100	Heaney, Needle Holder82-85
Fomon, Rhinoplastic Knife180	Forceps, Tunneling-49	Graft Packer186	Hegar, Needle Holder86
Forceps for kidney and pancreas.....132	Forceps, Uterine Biopsy-165	Graham, Dura Hook143	Hegar, Uterine Dilator.....161
Forceps for Vena Cava131	Forceps, Uterine Polypus-163	Graham, Septum Forceps177	Hegar, Uterine Dilators, Set.....162
Forceps, Applying.....128	Forceps, Uterine Seizing-164	Grave, Vaginal Speculum159	Hegar-Baumgartner, Needle Holder82, 85
Forceps, Applying/Removal-140	Forceps, Uterine Tenaculum.....162-163	Green-Armytage, Uterine Clamp.....167	Hegar-Vascular, Needle Holder.....86
Forceps, Approximation-90	Forceps, Vascular-128, 136	Greene, Uterine Curette166	Heigenbarth, Clip Applying Forceps90
Forceps, Atraumatic Micro-33	Forceps, Vena Cava-131	Gregory, Carotid Clamp124	Heister, Brain Spatula142, 142
Forceps, Bone Contouring-204, 206	Forceps, Waste.....214	Gregory, Face-lift Scissors147	Heiming, Kidney Stone Forceps155
Forceps, Bone Cutting-118-119, 205	Forceps, Wire Bending.....170	Gregory, Micro Needle Holder84	Heiss, Dissecting & Ligature Forceps.....41
Forceps, Bone Holding-112, 113-115	Forceps, Wire Catching-38	Gregory, Profunda Clamp.....125	Heister, Mouth Gag186
.....193-194, 196, 205	Forceps, Wire Twisting-97, 204	Gregory, soft, Carotid Clamp124	Hemorrhoidal Grasping Forceps154
Forceps, Capsule.....157	Foreign Body Forceps158	Groningen, Nerve Hook142	Hemorrhoidal Ligator154
Forceps, Cartilage Seizing-113	Foreign Body Instrument.....174	Grooved Director92	Henke, Tonsil Elevator198
Forceps, Catheter Introducing.....79	Foreign Body Lever.....173, 174	Gross, Ear Scoop/Hook.....174	Henley, Central Blade67
Forceps, Cilia-34	Fork, Ligature-90	Gross-Maier, Dressing Forceps49	Henley, Wound Spreaders, self-retaining.....67
Forceps, Clip Applying-35, 90, 140	Fork, Tuning-172	Grünwald (Jansen), Nasal Tampon Forceps177	Hennig, Plaster Spreader94
Forceps, Columella-184	Förster, Sponge Forceps.....50	Grünwald, Ear Forceps.....173	Heparin Flushing Needle.....78
Forceps, Columella Suturing.....184	Foster-Gillies, Needle Holder87	Guide Needle.....78	Hepp-Scheidel, Micro Needle Holder84
Forceps, Combi-Wire Twisting-97	Fox, Lupus Curette147	Guide Support.....182	Hepp-Scheidel, Tubal forceps32
Forceps, Disimpaction-193, 207	Fraenkel, Exchangeable Tip200	Guide, Wire Saw.....140	Herbert, Mallet.....105
Forceps, Dissecting-27-28, 29,31, 32	Fragment Adapting Forceps.....203	Guilen, Suction Raspatory185	Heymann, Nasal Scissors15
Forceps, Dissecting & Ligature-37,38,39,41,44,45	Frame for Mouth Gag.....187	Gum Scissors.....16,25	Heywood-Smith, Uterine Polypus Forceps163
Forceps, Dressing-.....26,27,28, 29, 31,32, 49	Frazier, Dura Hook.....143	Guthrie, Skin Hook.....51	Hibbs, Chisel102
Forceps, Ear-173	Frazier, Suction Cannula76	Guttman, Vaginal Speculum159	Hibbs, Gouge.....102
Forceps, Ear Polypus-173	Freeman, Face-lift Scissors147	Guyon, Kidney Pedicle Clamp.....44,45	Hibbs, Osteotome.....102
Forceps, Etmoid Bone.....177,178	Freeman-Kaye, Face-lift Scissors.....147	Guyon, Urethral Sound158	Hohmann, Bone Lever111
Forceps, Eyelet-208	Freer, Mucosa Hooklet184	Gynecological Scissors.....9	Hohmann, mini, Bone Lever110
Forceps, Face-lift-37, 147	Freer, Mucosa Knife180	H	Hoke, Osteotome.....102
Forceps, for kidney & pancreas132	Freer, Septum Chisel181	Hach, Fasciotomy Knife138	Holder for Dissecting needles213
Forceps, Foreign Body-158	Freer, Septum Elevator180	Hach, Fasciotomy Spatula.....138	Holder, Chin-202
Forceps, Fragment Adapting.....203	Freer, Septum Gouge181	Haemostatic Forceps36-41, 45, 124, 135	Holder, Napkin.....919
Forceps, Gall Stone-156	Freer, Septum Knife180	Haight, Rib Retractor.....121	Holsher, Nerve Root Retractor.....142
Forceps, Haemostatic-36-41, 45, 124, 135	French, Tuning Fork.....172	Hajek, Sphenoid Bone Punch179	Hook, Bone-207
Forceps, Hemorrhoidal Grasping-154	Friedmann, Bone Rongeur.....115	Hajek-Kofler, Sphenoid Bone Punch.....179	Hook, Exploring-171
Forceps, Hysterectomy.....46, 47	Fritsch, Retractor59	Halle, Bone Curette106	Hook, Fistula-164
Forceps, Intestinal & Tissue Grasping-....148-149	Fritz, Cane214	Halle, Bone Elevator180	Hook, Galea-141
Forceps, Introducing.....170	Frontal Template208	Halsey, Needle Holder82, 85	Hook, Micro Ear-170,171
Forceps, IUP Grasping-165	Frosch, Bone Holding Forceps113	Halsted-Mosquito, Haemostatic Forceps..37,38	Hook, Nasal-.....183
Forceps, Jeweler Type-31	Frykholm, Bone Rongeur117	Hammer, Percussion-73	Hook, Nerve-142
Forceps, Kidney Stone.....155	Fuller, Introducing Forceps.....170	Hand Drill96	Hook, Orbital-193
Forceps, Laryngeal Polypus200	G	Hand Restraint119	Hook, Saddle-48-52, 53-, 184
Forceps, Ligature-37, 129, 131-132	Gag, Mouth-186-188	Hand, Lead.....119	Hook, saddle shaped184
Forceps, Ligature Carrying.....157	Galea hook141	Handle, Wire Saw.....140	Hook, Skin,51
Forceps, Liver-132	Gall Duct Dilator155	Handle, Universal-199	Hook, TMJ-Condyle-194
Forceps, Lung Grasping-124	Gall Stone Forceps156	Handle for Biopsy Forceps.....154	Hook, Tracheal-145,146
Forceps, Micro-27, 30, 32-33	Gall Stone Scoop.....156	Handle for Vaginal Speculum161	Hook, Vein-.....53
Forceps, Micro Dilating.....32-33	Gallaher, Antrum Rasp.....182	Handle, Chisel-100	Hook, Vessel-51
Forceps, Micro Ear-179	Gardner, Bone Chisel99	Handle, Laryngeal Mirror.....200	Hooklet51-52, 53
Forceps, Micro Ring-32-33	Gauge158	Handle, Scalpel2,3,4	Hooklet, Alar-183,184
Forceps, Micro Tying.....33	Gauze Packer199	Handle, Suction-77	Hooklet, Bone-51
Forceps, Micro-, with counterbalance32	Gauze Packer.....199	Handle, Universal-199	Hooklet, Cleft Palate-198
Forceps, Microscopic.....33	Gellhorn, Uterine Biopsy Forceps165	Hank, Uterine Dilator.....162	Hooklet, Ear-174
Forceps, Nasal-182	Gelpi, Wound Spreaders, self-retaining69	Hank, Uterine Dilators, Set162	Hooklet, Face-lift-147
Forceps, Nasal Cutting-177-178	Gemini, Dissecting & Ligature Forceps43	Hargis, Anterior Border Stripper.....196	Hooklet, Micro-51
Forceps, Nasal Polypus.....177	Gerald, Dissecting Forceps27, 30	Hargis, Bone Holding Forceps.....196	Hooklet, Mucosa-183,184
Forceps, Nasal Tampon.....177	Gerald, Dressing Forceps.....27	Hargis, Lip & Cheek Retractor196	Hooklet, Nerve-138
Forceps, Nephrostomy-177	Gierzt-Stille, Rib Shear120	Hargis, Mandibular Body Retractor.....196	Hooklet, Nerve & Vessel143
Forceps, Obstetrical-167	Gigli, Wire Saw140	Hargis, Periform Rim Retractor196	Hooklet, saddle shaped.....207
Forceps, Organ Grasping-37, 151	Gigli, Wire Saw Handle140	Hargis, Periosteal Elevator.....196	Hooklet, Skin-147, 204
Forceps, Peritoneum-47	Gillies, Dissecting Forceps27, 30	Hargis, Pterygoid Osteotome.....196	Hopkins, Plaster Knife94
Forceps, Placenta & Ovum-167	Gillies, Needle Holder.....83, 87	Hargis, Ramus Retractor196	Hösel, Retractor58
Forceps, Rectal Biopsy-154	Gillies, Skin Hooklet147	Hargis, Retractor Chain.....196	House, Micro Curette171
Forceps, Reposition-.....113	Gillies, Zygoma Elevator.....193	Harken, Auricle Clamp.....132	House, Micro Measuring Rod.....171
Forceps, Septum-177,178,184	Gillies-Mini, Needle Holder87	Harrington, Retractor62	House-Dieter, Malleus Nipper170
	Gil-Vernet, Saddle Hook.....53	Hartmann, Bone Rongeur.....116	Huber, Universal Handle199
	Glabella Rasp183	Hartmann, Ear Catheter173	Humby, Dermatome.....05

Alphabetical Index



Humby, Spare Blade.....05	K	Kocher-Langenbeck, Retractor.....57	Ligature Catcher.....90, 138
Hunter, Splinter Forceps33	Kahre-Williger, Periosteal Elevator.....108	Kocher-Nippion, Haemostatic Forceps.....39	Ligature Conductor.....90
Hurd, Cleft Palate Needle198	Kallmorgen, Vaginal Retractor.....160	Kogan, Endocervical Speculum.....161	Ligature Forceps37, 129, 131, 194
Hurd, Tonsil Dissector/Retractor.....198	Kalt, Needle Holder.....81	Kolle, Holder for dissecting needles213	Ligature Fork90
Husfeldt, Peripheral Vascular Clamp127	Kaye, Face-lift Hooklet.....147	Kölnner, Scalp Clip140	Ligature Needle90
Hypodermic Needle78	Kaye, Face-lift Scissors.....44, 77, 742	König, Tuning Fork172	Light Carrier, Fiber Optic.....153 157
Hysterectomy Forceps.....46, 47	Kaye, Scalpel Handle03	Körte, Retractor55	Lindemann, Burr186
Hysterectomy Scissors.....24, 25	Kaye-Millard, Hooklet230	Krause, Exchangeable Tip200	Lip and Cheek Retractor188, 196
I	Keen, Bone Holding Forceps194	Krause, Polypus Snare173,175	Lister, Bandage Scissors93, 94
I.M.F. Bone Wire98	Keith, Surgical Needle.....80	Krause-Voss, Polypus Snare.....173,175	Lister, Sinus Forceps49
Iliac Clamp.....137	Keil, Dissecting & Ligature Forceps.....45	Krayenbühl, Nerve & Vessel Hooklet.....143	Liston, Bone Cutting Forceps.....118
Iliac Crest Retractor.....205	Kelly, Haemostatic Forceps38	Krenkel, Cleft Palate Periosteal Raspatory.....180	Liston-Key, Bone Cutting Forceps119
Immobilizer, Hand.....323	Kelly, Operating Scissors.....09, 25	Krenkel, Periosteal Elevator.....192	Littauer, Cilia Forceps.....34
Incision Scissors.....07	Kelly, Retractor58 63	Kressner, Septum Forceps.....184	Littauer, Ear Polypus Forceps173
Infusion Stand213	Kelly, Sphincteroscope.....154	Kristeller, Vaginal Retractor159,160	Littauer, Stitch Scissors19
Inge, Lamina Spreader.....143	Kelly, Uterine Polypus Forceps163	Kristeller, Vaginal Speculum159,160	Little, Retractor.....56
Inlay, Silicone187	Kelly-Rankin, Haemostatic Forceps38	Kronecker, Ligature Needle89	Littauer, Stitch Scissors19
Insert212	Kern, Bone Holding Forceps114	Kümmel, Abdominal Spatula.....64	Loading Cone.....154
Insert for Cup.....212	Kerrison, Antrum Punch.....179	L	Locklin, Gum Scissors16, 25
Instrument Box211,212	Kerrison, Laminectomy Punch144	La Grange, Gum Scissors16	Lockwood, Intestinal & Tissue
Instrument Circumcision-158	Keorkian, Uterine Biopsy Curette.....164	Laborde, Tracheal Dilator145	Grasping Forceps148
Instrument Tray.....211	Keyes, Dermal Punch147	LA Force185	Logan, Wound Spreaders, self-retaining.....65
Instrument, Bone Biopsy.....103	Kidney Dish1069	Lahey, Bile Duct Clamp.....44	Loop Retainer63
Instrument, Condylar Repositioning-192	Kidney Pedicle Clamp.....44,45	Lahey, Retractor56	Loop, Ear.....174
Instrument, Foreign Body.....152	Kidney Stone Forceps155	Lambert-Kay, Anastomosis Clamp133	Loop, Specimen-213
Instrument, Plate-pulling-193	Kielland, Obstetrical Forceps.....167	Lambotte, Osteotome.....101	Loop, Wire-177
Instrument, Reposition-197	Kielland-Luikart, Obstetrical Forceps.....167	Lambotte, Periosteal Elevator108	Lorenz, Bandage Scissors.....93
Instrument, Tendon Passing-112	Killian, Nasal Speculum175	Lambotte-Mini, Osteotome101	Lorna, Towel Clamp48
Instrument, Urethrography-158	Killian, Septum Elevator.....180	Lamina Spreader143	Love, Nerve Root Retractor.....142
Insufflation Cannula78	Killian, Septum Gouge.....181	Laminectomy Punch.....143,144	Love-Grünwald, Laminectomy Rongeur145
Interchangeable Tube199	Killian-Claus, Septum Gouge.....181	Laminectomy Rongeur145	Loveless, Haemostatic Forceps.....39
Interior Box.....1043	Kilner, Alar Hooklet184	Lamp, Spirit-213	Lovelace, Lung Grasping Forceps124
Internal Progeny Retractor.....191,192	Kilner, Dissecting Scissors13	Lancet, Tympanum-174	Lower, Dissecting & Ligature Forceps44
Intestinal and Pylorus Clamp.....150	Kilner, Needle Holder85	Landolt, Tumor Grasping Forceps145	Lubet-Barbon, Nasal Tampon Forceps177
Intestinal and Tissue Grasping Forceps...148,149	Kilner, Skin Hooklet147	Lane, Bone Holding Forceps.....115	Luc, Ethmoid Bone Forceps177
Intima Spatula138	Kilner-Doughty, Frame for Mouth Gag.....187	Lane, Stomach & Intestinal Anastomosis	Lucae, Ear Hooklet176
Intra Oral Retractor190	Kilner-Doughty, Mouth Gag.....187	Twin Clamp.....150	Lucae, Mallet.....103
Introducing Forceps.....170	Kilner-Doughty, Tongue Depressor.....187	Lange, Alar Hooklet183	Lucae, Tuning Fork.....173
Iowa, Uterine Tenaculum Forceps163	Kirschner, Blade72	Lange, Exchangeable Tip.....200	Lucae, Tympanum Needle174
Iris Scissors66-68, 105	Kirschner, Frame.....72	Lange-Hohmann, Bone Lever.....111	Luer, Bone Rongeur116
Irrigation Adapter175	Kirschner, Ligature Conductor90	Langenbeck, Amputation Saw.....95	Luer, Suction Tube77
Israel, Retractor55	Klapp, Retractor.....53	Langenbeck, Bone Holding Forceps113	Luer, Tracheal Hook.....145
Iterson, Tracheal Hook145	Kleinert-Kutz, Tendon Holding Forceps.....112	Langenbeck, Ear Curette174	Luer-Körte, Gall Stone Scoop.....156
IUP Grasping Forceps165	KLING-EX, Scalpel Blade Remover03	Langenbeck, Finger Protector186	Lukens, Tracheal Hook.....145
Ives-Fansler, Anuscope153	Knee Retractor.....111	Langenbeck, Needle Holder.....88	Lumbar Puncture Needle78
J	Knife / Enucleator, Tonsil-198	Langenbeck, Periosteal Elevator.....107	Lung Grasping Forceps124
JABOMA, Cleft Palate Periosteal Elevator198	Knife, Amputation-04	Langenbeck, Resection Knife.....06	Lung Spatula123
JABOMA, Dissecting Forceps.....29	Knife, Autopsy-01	Langenbeck, Retractor.....55	Luniatschek, Gauze Packer199
JABOMA, Dressing Forceps29	Knife, Brain-01	Langenbeck-Mini, Hooklet.....52	Lupus Curette147
JABOMA, Micro Needle Holder84	Knife, Cartilage-01	Laryngeal Mirror200	Lupus Scraper.....147
JABOMA, Micro Scissors19	Knife, Circular Cut-170	Laryngeal Mirror Handle.....200	M
Jackson, Tracheal Hook.....146	Knife, Conization-164	Laryngeal Polypus Forceps200	M. G. Hospital, Needle Holder50
Jackson, Vaginal Speculum159	Knife, Dissecting-01	Laryngeal Tube.....199	Magill, Catheter Introducing Forceps.....79
Jacobs Chuck with three jaws96	Knife, Fasciotomy-138	Laryngoscope Set79	Magnifying Glasses.....75
Jacobs, Uterine Tenaculum Forceps163	Knife, Flap-170	Lateral Blade.....70-71, 124-122, 153, 157	Mallet92,73
Jacobson, Micro Scissors18	Knife, Meniscus-111	Lawrence, Dissecting & Ligature Forceps45	Malleus Nipper170
Jameson, Dissecting Scissors13	Knife, Millium-147	Lead Hand.....119	Maltz, Nasal Rasp182,183
Jamison, Needle Holder82	Knife, Mucosa-170,180	Lees, Bronchus Clamp133	Mandibular Body Retractor.....196
Jansen, Bone Rongeur116	Knife, Myoma-164	Leksell-Stille, Bone Rongeur116	Mandibular Inferior Border Raspatory202
Jansen, Ear Forceps173	Knife, Plaster-94	Leland-Jones, Peripheral Vascular Clamp.....129	Mandibular Retractor.....201
Jansen, Ear Scoop.....174	Knife, Post Mortem-01	Lempert, Bone Rongeur116	Manometer75
Jansen, Wound Spreaders, self-retaining.....65	Knife, Razor-05	Lempert, Ear Scoop.....174	Manometer, Blood Pressure.....75
Jar, Metal-211	Knife, Resection-05	Lempert, Micro Ear Periosteal Elevator174	Marchac, Caliper208
Javid, Carotid Shunt Clamp126	Knife, Resection-, for TMJ.....194	Leriche, Haemostatic Forceps.....38	Marchac, Frontal Template208
Jennings, Mouth Gag188	Knife, Rhinoplastic-180	Lever, Bone-110,111	Marchac, Periosteal Elevator208
Jeter-Van Sickels, Bone Holding Forceps193	Knife, Septum-180	Lever, Foreign Body-173,174	Marquard, Bone Rongeur116
Jeweler mod., Micro dilating Forceps32	Knife, Sickle-170	Lever, Obstetrical-167	Martel-Rees, Face-lift Forceps37
Jeweler mod., Micro Forceps32	Knife, Swivel-180	Lewin, Bone Holding Forceps113	Martin Assistent-Standard, Suture Set.....91
Jeweler Type Forceps31	Knife, Tonsil-198	Lewis, Nasal Rasp183	Martin Mini-Assistent, Suture Set90
Johns-Hopkins, Bulldog Clamp35	Knife, Trowel-168	Lexer, Dissecting Scissors11,22	Martin Multi-Assisten, Suture Set91
Johnson, Needle Holder83	Knight, Septum Forceps177	Lexer, Gouge.....101	Martin, Cartilage Seizing Forceps.....113
Jones, Towel Clamp47	Knot Tier90	Lexer, Osteotome.....101	Martin, Combi-Wire Twisting Forceps.....97
Jones-Martin, Towel Clamp.....47	Knutson, Urethrography Instrument158	Lexer, Spongiosa Gouge100	Martin, Dressing Forceps.....49
Joseph, Bone File.....182	Knobson-Koch, Cone158	Lexer-Mini, Gouge100	Martin, Nasal Speculum175
Joseph, Mucosa Hooklet183,184	Koberg, mod., Retractor.....191	Lexer-Mini, Osteotome100	Martin, Needle Holder86
Joseph, Nasal Saw182	Koberg, Retractor191	Leyla, Self-Retaining Retractor	Martin, Pelvimeter.....167
Joseph, Operating Scissors.....12,22	Kocher (Ochsner), Haemostatic Forceps .40-41	Lichtenberg, Needle Holder.....83,88	Martin, Peripheral Vascular Clamp126
Joseph, Periosteal Elevator.....181	Kocher, Goitre Enucleator146	Lid for Kidney Dishes212	Martin, Peripheral Vascular Clamp126
Joseph, Rhinoplastic Knife.....180	Kocher, Haemostatic Forceps39	Lid for Petri Dishes211	Martin, Plaster Knife94
Joseph, Septum Elevator.....180	Kocher, Intestinal Clamp149-150, 151-152	Lid only.....211	Martin, Retractor.....55
Joseph-Masing, Periosteal Elevator181	Kocher, Retractor54, 56, 57, 59	Ligator, Hemorrhoidal-154	Martin, Retractor.....59
Judd-Allis, Intestinal & Tissue Grasping		Ligature Carrying Forceps.....157	Martin, Tongue Spatula.....189
Forceps145			Martin, Tuning Fork172
Judd-Masson, Bladder Retractor157			Martin, Vascular Measuring Caliper127
Jurasz, Laryngeal Polypus Forceps200			



Alphabetical Index

Martin, Waste Forceps	214	Micro Curette.....	171	Multi purpose Vascular Clamp	125, 129-130, 134-135, 137-	Obwegeser, Osteotome for Alveolar Process.....	203
Martin, Wire Twisting Forceps	97	Micro Dilating Forceps.....	32,33	Museux, Uterine Tenaculum Forceps	163	Obwegeser, Periosteal Elevator	192
Martin-Alloy, Tuning Fork	172	Micro Dissecting Scissors.....	18	Myoma Knife	164	Obwegeser, Ramus Clamp	202
Martin-Cushing, Periosteal Elevator.....	107	Micro Dissector	90, 171	Myoma Screw	164	Obwegeser, Ramus Periosteal Elevator.....	202
Martin-Fuchsig, Dissecting & Ligature Forceps	39	Micro Ear Forceps	169	Myrtle Leaf Probe.....	92	Obwegeser, Ramus Retractor	191,201
Martin-Hoen, Periosteal Elevator.....	107	Micro Ear Hook	170,171	N		Obwegeser, Septonasal Osteotome	202
Martini, Needle Holder	87	Micro Ear Needle	170	Nägele, Obstetrical Forceps.....	167	Obwegeser, Soft Tissue Retractor	191,201
Martin-Langenbeck, Elevator	109	Micro Ear Periosteal Elevator	171,174	Napkin Holder.....	186	Obwegeser, Swallowtail Raspatory	202
Martin-Langenbeck, Periosteal Elevator	107	Micro Ear Scissors.....	169	Nasal Cutting Forceps.....	177,178	Obwegeser, Third Molar Retractor	201
Martin-Proper, Drill Collecting Box	209	Micro Elevator.....	109	Nasal Forceps	182	Obwegeser, Tuberosity Osteotome	203
Martin-Simplex, Cheek Retractor	188	Micro Forceps	27, 30, 32-33	Nasal Hook.....	183	Obwegeser, Wedge Osteotome.....	203
Martin-Vibroscrip, Electric Marking & Masing, Periosteal Elevator	181	Micro Forceps with counterbalance	32	Nasal Polypus Forceps	177	Obwegeser, Wire Catching Forceps	38
Masson, Needle Holder	83, 85	Micro Hooklet	51	Nasal Rasp	182,183	Obwegeser, Wire Pincer.....	204
Mastoid Rongeur	173	Micro Measuring Rod.....	171	Nasal Retractor	183-184	Obwegeser, Wire Twisting Forceps	204
Mathieu, Foreign Body Forceps.....	158	Micro Needle Holder	80-81, 84,85	Nasal Saw	182	Obwegeser, Zygomat Arch Awl.....	203
Mathieu, Needle Holder	83, 87,88	Micro Phlebextractor.....	92	Nasal Scissors	11,15	Ochsner, Aortic Clamp	125
Mathieu, Retractor	65	Micro Ring Forceps	32,33	Nasal Speculum.....	175,476,204	Ochsner-Martin, Trocar.....	76
Maunder, Mouth Gag	186	Micro Scalpel Blade	04	Nasal Spine Retractor.....	190,201	O'Connor, Skin Hook.....	51
Maxillary Awl	203	Micro Scissors	17,19	Nasal Tampon Forceps.....	177	Oehler, Dissecting Forceps	28
Maxillary Mobilizer	193, 203	Micro Scissors for veins	18	Needle Case	209	Ogura, Skin Grasping Forceps.....	184
Mayfield, Bone Rongeur.....	116	Micro Suction Cannula.....	76	Needle Holder	81,84,88,89	Oldberg, Pituitary Rongeur	145
Mayo, Dissecting Forceps.....	32	Micro Tying Forceps.....	33	Needle Holder, Micro.....	80,84	Olive	77
Mayo, Operating Scissors	21	Microscopic Forceps	33	Needle, Cleft Palate-	85	Olive, Metal-	175
Mayo, Safety Pin	210	Microvascular, Needle Holder	87	Needle, Dissecting-	198	Olivecrona, Brain Spatula.....	142
Mayo-Blake, Gall Stone Forceps.....	156	Middeldorpf, Retractor.....	58,59	Needle, Dissecting-	213	Olivecrona, Trigeminal Scissors.....	14
Mayo-Harrington, Dissecting Scissors	08	Middleton-Jansen, Septum Forceps.....	178	Needle, Guide-.....	78	Olivecrona-Toennis, Clip Applying Forceps.....	140
Mayo-Hegar, Needle Holder.....	82-85	Mikro-Adson, Dissecting Forceps	31	Needle, Heparin Flushing.....	78	Ollier, Retractor.....	55
Mayo-Lexer TCC-BlackLine	22	Mikro-Adson, Dressing Forceps	31	Needle, Hypodermic-	78	Olsen-Hegar, Needle Holder	83,87
Mayo-Lexer, Dissecting Scissors.....	20	Mikro-Friedman, Bone Rongeur	116	Needle, Ligature-	89	Operating Scissors	6,7,9,12,16
Mayo-Noble, Dissecting Scissors.....	08	Mikro-Hegemann, Coronary Scissors.....	13	Needle, Lumbar Puncture-	78	Orbital Hook	20-21, 22, 25
Mayo-Robson, Intestinal Clamp	149, 151	Mikro-Mosquito, Haemostatic Forceps	38	Needle, Micro Ear-	170	Orbital Rim Retractor.....	193
Mayo-Stille, Dissecting Scissors.....	08, 21	Mikulicz, Peritoneum Forceps	47	Needle, Pudendus Anaesthesia-.....	78	Organ Grasping Forceps	37,151
McDonald, Dissector, double-ended	110	Mikulicz, Retractor	63	Needle, Reverdin-	88	Oringer, Lip & Cheek Retractor	188
McGee, Micro Ear Hook	170	Mikulicz-Baby, Peritoneum Forceps.....	47	Needle, Surgical.....	80	O'Shaughnessy, Dissecting & Ligature Forceps.....	43
McGee, Wire Bending Forceps	170	Milium Knife.....	147	Needle, Tonsil-	78	Osteotome.....	99, 100, 101-102
McGinvey, Hemorrhoidal Grasping Forceps.....	154	Miller, Laryngoscope Set	79	Needle, Tympaanum-	174	Osteotome Blade.....	100
McIndoe, Dressing Forceps	26, 27	Miller-Baby, Laryngoscope Set	79	Neff, Meniscus Knife.....	111	Osteotome for Alveolar Process	203
McIntosh, Laryngoscope Blade	79	Miller-Colburn, Bone File	109	Negus, Haemostatic Forceps	45	Osteotome, Cleft Palate-	207
McIntosh, Laryngoscope Set.....	79	Milligan, Wound Spreaders, self-retaining	67	Neivert, Alar Hooklet	184	Osteotome, Pterygoid-.....	196
Mclvor, Frame for Mouth Gag	187	Millin, Bladder Neck Spreader.....	157	Neivert, Needle Holder	82	Osteotome, Raspatory.....	197
Mclvor, Mouth Gag	187	Millin, Bladder Retractor.....	157	Neivert-Anderson, Chisel.....	182	Osteotome, Septonasal-	203,207
Mclvor, Tongue Depressor.....	187	Millin, Capsule Forceps	157	Nelson, Dissecting Forceps	32	Osteotome, Tuberosity-	203
McKenty, Septum Elevator	180	Millin, Ligature Carrying Forceps.....	157	Nelson, Trocar.....	76	Osteotome, Wedge-	203
McKenzie, Clip Applying Forceps	140	Mini Phlebextractor	92	Neonatal Vascular Clamp	139	O'Sullivan-O'Connor, Abdominal Retractor	72
McKesson, Chain	186	Mini-Adson, Dissecting Forceps	31	Nephrostomy Forceps	155	Overholt, Dissecting & Ligature Forceps.....	42
McKesson, Mouth Gag	186	Mini-Gemini, Dissecting & Ligature Forceps.....	43	Nerve and Vessel Hooklet	143	Overholt-Baby, Dissecting & Ligature Forceps	38
McQuigg-Mixter, Dissecting & Ligature Forceps	44	Mini-McGee, Micro Ear Forceps	169	Nerve Hook	142	Overholt-Fino, Dissecting & Ligature Forceps	42
Mead, Bone Rongeur	116	Mirror.....	74	Nerve Hooklet	138	Overholt-Geissendorfer, Dissecting & Ligature Forceps	42
Mead, Mallet	104	Mirror, Head-	74	Nerve Root Retractor	142	Overholt-Martin,Dissecting & Ligature Forceps	41
Measurer	211	Mirror, Laryngeal-	200	Neukam, Frame	187	Overholt-Mini,Dissecting & Ligature Forceps	42
Meatotome	158	Mixer, Dissecting & Ligature Forceps.....	43,44	Neukam, Mouth Gag.....	187	Overholt-Mixter,Dissecting & Ligature Forceps	41
Medicine Cup	212	Mixer, Gall Stone Forceps	156	Neukam, Tongue Depressor	187	Oxygen Cylinder Carriage.....	213
Medicine Spoon	212	Mixer-Baby, Dissecting & Ligature Forceps.....	37	Neuro, Tuning Fork.....	172	P	
Meeker, Dissecting & Ligature Forceps	45	Mixer-O'Shaughnessy, Dissecting & Ligature Forceps	43	Neurosurgical Scissors.....	14	Packer, Graft-.....	186
Meniscus Knife	111	Mobalizer, Maxillary-	193, 203	Nipper, Malleus.....	170	Palate Plate	187
Metal Catheter, female.....	158	Mobilizing Retractor	208	Norfolk-Norwich, Wound Spreaders self-retaining	66	Pan, Bed-	212
Metal Cup.....	212	Mock, Heparin Flushing Needle	78	Northbent, Stich Scissors.....	19	Pan, Placenta-	212
Metal Jar	211	Mod. Bonn, Iris Scissors	1	Noto, Uterine Polypus Forceps.....	163	Parker, Retractor	64
Metal Olive	175	Mod. Martin, Ligature Conductor	90	Novak, Suction Curette	164	Parker-Langenbeck, Retractor.....	65
Methot, Cotton Dispenser.....	212	Mod. München, Uterine Biopsy Curette	164	Nozzle, Suction-.....	175	Parker-Mott, Retractor	64
Methot, Insert	212	Mod. USA, Bone Curette	106	Nuboer, Suction Tube	74	Parkes, Rhinoplastic Chisel	182
Methot, Waste Cotton Collector.....	212	Mod. USA, Umbilical Scissors	16	O		Partsch, Chisel.....	99
Metz, Progeny Retractor.....	191	Mod. Wien, Nasal Speculum.....	176	Obstetrical Forceps	167	Partsch, Chisel.....	99
Metzenbaum, Dissecting Scissors	10	Modell USA, Bone Curette	106	Obturator.....	185	Partsch, Mallet.....	104
Metzenbaum, Dissecting Scissors	21,22	Modell USA, Bone Curette	106	Obwegeser, Blade Osteotome.....	203	Partsch, Periosteal Elevator	195
Metzenbaum, Needle Holder	82	Modell USA, Bone Curette	106	Obwegeser, Bone Contouring Forceps	204	Passer, Tendon-	112
Metzenbaum-Aquila, Dissecting Scissors	20	Modell USA, Bone Curette	106	Obwegeser, Channel Retractor	202	Payr, Intestinal & Pylorus Clamp	150
Metzenbaum-Aquila-Fino Dissecting Scissors.....	20	Modell Wien, Ligature Catcher	90	Obwegeser, Cheek Retractor	188	Payr, Ligature Conductor	90
Metzenbaum-Fino, Delicate Dissecting Scissors.....	20	Mogen, Circumcision Instrument	158	Obwegeser, Chin Holder	202	Payr-Baby, Intestinal & Pylorus Clamp.....	150
Metzenbaum-Fino, Delicate Dissecting Scissors.....	11-12,22-23	Moldenhauer, Foreign Body Lever	174	Obwegeser, Chin Retractor	191	Pean (Rochester), Haemostatic Forceps.....	40
Metzenbaum-Lahay, Dissecting Scissors	23	Mollison, Wound Spreaders, self-retaining	67	Obwegeser, Elevator.....	192,202	Pean, Haemostatic Forceps	36,39
Metzenbaum-Nelson, Dissecting Scissors	10	Molt, Bone Curette	107	Obwegeser, Eyelet forceps	208	Pean-Nippon, Haemostatic Forceps.....	39
Metzenbaum-TCC-BlackLine	23	Molt, Bone Curette, double-ended.....	107	Obwegeser, Flat Nose Plier	204	Peck-Joseph, Face-lift Scissors.....	12
Metzenbaum-TCC-BlackLine-Fino	23	Molt, Mouth Gag	186	Obwegeser, Fragment Adapting Forceps.....	203	Pederson, Vaginal Speculum	159
Metzenbaum-Thorek, Dissecting Scissors.....	22	Molt, Mouth Gag	186	Obwegeser, Mandibular Inferior Border Raspatory.....	202	Pediatric Vascular Clamp	136,139
Metz-Lauer, Internal Progeny Retractor.....	191	Moncorps, Milium Knife.....	147	Obwegeser, Mandibular Retractor.....	201	Peers-Bertram modif, Towel Clamp.....	48
Meyerding, Hooklet	52	Moncorps, Spare Blade	147	Obwegeser, Maxillary Mobilizer	203	Peers-Bertram, Towel Clamp.....	48
Michel, Clip Applying Forceps	90	Morris-De Bakey, Aortic Clamp	133	Obwegeser, Mouth Gag	186	Peet, Splinter Forceps	34
Michel, Laryngeal Mirror	200	Morse, Sternal Retractor	121	Obwegeser, Nasal Spine Retractor.....	191,201		
		Morse-Favaloro, Sternal Retractor	121	Obwegeser, Osteotome.....	192,203		
		Morselizer, Septum-	178				
		Mouth Gag	186-188				
		Moynihan, Bile Duct Clamp.....	46				
		Mucosa Hooklet	183,184				
		Mucosa Knife.....	170, 180				
		Multi purpose Retractor	190				

Alphabetical Index



Q							
Pelvimeter	167	Quattro, Plaster Spreader	94	Retractor, Spinal-	111	Satinsky, Tangential Occlusion Clamp.....	132
Pelvis Retractor.....	63	Quinke, Lumbar Puncture Needle	78	Retractor, Sternal-	121	Satinsky, Vascular Clamp	132
Penfield, Dura Dissector	141	Quire, Foreign Body Lever	173	Retractor, Third Molar.....	201	Satinsky, Vascular Scissors.....	13
Penis Clamp	158	R		Retractor, Thoracic-.....	205	Satterlee, Amputation Saw	95
Pennington, Haemostatic Forceps	137	Rack, Syringe-	212	Retractor, Thoracic & I.M.A-	123	Satterlee, Spare Saw Blade	95
Pennington, Septum Elevator	180	Rack, Urinal-	214	Retractor, Thyroid & Vaginal-	69	Sauerbruch, Bone Rongeur.....	118
Percussion Hammer	73	Ragnell, Dissecting Scissors	25	Retractor, Vaginal-.....	159	Sauerbruch, Needle Case	209
Percy, Amputation Retractor	115	Ragnell-Davis, Hooklet.....	52	Retractor, Vestibulum-.....	188	Sauerbruch, Retractor.....	36,37
Periform Rim Retractor	196	Ralk, Splinter Forceps	34	Reverdin Needle	88	Sauerbruch, Rib Shear.....	120
Periosteal Elevator.....	107,180,180,191	Ramplsey, Sponge Forceps	50	Reverdin, Reverdin Needle	88	Sauerbruch, Waste Forceps	214
Pin, Safety-.....	192,195,196,202,206,207	Ramus Clamp	197,201	Richter, Clip Applying Forceps.....	13	Saw Blade	03
Peripheral Vascular Clamp	125,126,127,129	Ramus Osteotome	197	Rhinoplastic Chisel.....	182	Saw, Amputation-.....	95
Peritoneum Forceps.....	47	Ramus Periosteal Elevator.....	202	Rhinoplastic Knife.....	180	Saw, Nasal-	182
Perthes, Reamer.....	96	Ramus Retractor	191,196,201,208	Rib Contractor.....	123	Scalp Clamp	204
Pestalozza, Placenta Scoop	167	Randall, Kidney Stone Forceps	155	Rib Raspatory	108	Scalp Clip.....	140
Petri Dish	211	Raney, Applying/Removal Forceps	140	Rib Retractor	120,121,122	Scalp-Contour, Wound Spreaders	
Phalangeal Elevator	109	Raney, Scalp Clip	140	Rib Shear	120	self-retaining	43
Phaneuf, Hysterectomy Forceps	46	Rasp, Antrum-	182	Ricard, Abdominal Retractor	70	Scalpel Blade Remover	03
Piece, Coupling.....	166	Rasp, Bone-.....	102	Ricard, Central Blade	70	Scalpel Blade, Micro-.....	04
Pier, Round / Flat Nose.....	197	Rasp, Glabella-	182	Ricard, Spreader, only	70	Scalpel Blade, non-sterile	03
Pierce, Micro Forceps	32	Rasp, Nasal-	182,183	Richardson, Retractor	58	Scalpel Blade, sterile.....	03
Pierce, Micro Forceps with counterbalance	32	Rasp, TMJ-	194	Richardson-Eastman, Retractor.....	58	Scalpel Handle	02,03,04
Pin, Safety-.....	210	Raspatory, Cleft Palate Periosteal.....	198	Richter, Clip Applying Forceps.....	90	Scalpel Handle, Swivel headed.....	02
Pinard, Stethoscope	73	Raspatory, Mandibular Inferior Border-	202	Ring, Rubber-.....	40	Scalpel, disposable	04
Piper, Obstetrical Forceps	167	Raspatory, Rib-.....	108	Ring, Silicone	119	Scapula Retractor	60
Pitha, Mouth Gag	186	Raspatory, Suction-	185	Ritter-Halle, Frontal Sinus Dilator	185	Schädel, Towel Clamp.....	47
Pittsburgh, Liver Forceps	132	Raspatory, Swallowtail-.....	202	Robb, Vascular Dissector.....	138	Schamberg, Comedone Extractor	147
Pituary Rongeur	143	Rasse, Bone Hooklet.....	51	Roberts, Dissecting & Ligature Forceps	141	Schede, Bone Curette	105
Placenta and Ovum Forceps	167	Rasse, Micro Hooklet.....	51	Rochester-Carmalt, Haemostatic Forceps.....	39	Scheibe, Organ Grasping Forceps.....	151
Placenta Pan	212	Razor Blade.....	02	Rod, Micro Measuring-.....	171	Scheinmann, Exchangeable Tip	200
Placenta Scoop	167	Razor Knife.....	05	Roeder, Towel Clamp	48	Scherbak, Handle for Vaginal Speculum.....	161
Plaster Breaker	94	Reamer	96	Roger, Septum Elevator.....	181	Scherbak, Specula Blade, only	161
Plaster Knife.....	94	Recamier, Uterine Curette	166	Rogers, Hysterectomy Forceps	46	Scherbak, Vaginal Speculum.....	161
Plaster Scissors.....	93,94	Record-Arkansas, Sharpening Stone.....	05	Rongeur, Cranial-	140	Scherbak, Weight for Vaginal Speculum.....	161
Plaster Shears.....	93	Rectal Biopsy Forceps	154	Rongeur, Laminectomy-	145	Schimmelbusch, Dressing Sterilizing Drum.....	209
Plaster Spreader.....	94	Rectal Scissors	19	Rongeur, Mastoid-.....	173	Schink, Dermatome	05
Plate Cutter	98	Rectal Speculum.....	153	Rongeur, Pityuary-	145	Schink, Skin Fixing Plate	05
Plate, Palate-.....	187	Rectal Spreader	153	Rose, Tracheal Hook	145	Schink, Spare Blade	05
Plate, Skin Fixing-.....	05	Redon, Guide Needle	78	Rosen, Circular Cut Knife.....	170	Schmeden, Nasal Cutting Forceps	178
Plate-pulling Instrument	193	Rees, Dressing Forceps	31	Rosen, Micro Ear Needle.....	170	Schmid, Vessel Irrigation Cannula.....	78
Plester, Flap Knife.....	170	Rees, Face-lift Scissors.....	23	Rosen, Micro Ear Periosteal Elevator	171	Schmieden, Ligature Needle	89
Plester, Wound Spreaders, self-retaining	67	Reiner, Plaster Knife.....	94	Rosenberg, Exchangeable Tip	200	Schmieden-Dick, Ligature Needle	89
Plier, Combi-Flat Nose-	97	Remover, Scalpel Blade-	03	Rosen-König, Mouth Gag	186	Schmieden-Taylor, Dura Scissors.....	14
Plier, Flat Nose-	97,204	Reposition Forceps	113	Ross, Aorta Retractor.....	61	Schnidt, Dissecting & Ligature Forceps	39
Pliers, Wire Cutting-.....	98	Reposition Instrument	197	Round / Flat Nose Plier.....	97	Schnidt, Tonsil Forceps.....	199
Pncer, Wire-.....	204	Resano, Sigmoid Anastomosis Forceps	153	Round Metal Box.....	212	Schröder, Uterine Tenaculum Forceps	162,163
Politzer, Tympanum Lancet	174	Resection Knife.....	05	Rowe, Disimpaction Forceps.....	193	Schubert, Uterine Biopsy Forceps	165
Politzer, Tympanum Needle	174	Resection Knife for TMJ.....	194	Rowe, Orbital Hook.....	193	Schuchardt, Progeny Retractor	191
Polloson, Retractor	61	Rest, Arm & Leg.....	214	Rowe, Wire Pusher	192	Schuchardt-Lauer, External Progeny	
Polypus Snare.....	173,176	Restrainer, Hand-.....	119	Rubber Insert.....	189	Retractor	191,192
Poole, Suction Tube.....	77	Retainer, Loop-.....	173	Rubber Ring	154	Schuhmacher, Umbilical Scissors	16
Poppen, Suction Cannula.....	73	Retention spring.....	175	Rubin, Osteotome	181	Schuknecht, Sickle Knife.....	170
Post Mortem Knife	01	Retractor.....	52,53,60,61,62,63,65	Rubin, Protection Cap.....	178	Schumacher, Exchangeable Tip.....	200
Pot, Powder-.....	212	Retractor Chain.....	196	Rubin, Septum Morselizer	178	Schumacher, Tip only	165
Potts, Anastomosis Clamp.....	129	Retractor, Abdominal-.....	70,71,72	Rudd, Hemorrhoidal Ligator	154	Schumacher, Uterine Biopsy Forceps	165
Potts, Coarctation Clamp.....	128	Retractor, Amputation-.....	115	Rudd, Loading Cone	154	Scissors, angled	24
Potts, Micro Scissors	18	Retractor, Aorta-.....	61	Rumel, Dissecting & Ligature Forceps	43	Scissors, Bandage-	93,94
Potts, Multi purpose Vascular Clamp	134	Retractor, Atrium-	63	Rumel-Belmont, Tourniquet.....	134	Scissors, Coronary-.....	13,14
Potts-Smith, Dissecting Forceps	30	Retractor, Bladder-.....	157	Ruskin, Bone Rongeur	116	Scissors, Dissecting-, delicate	11,12,22,23
Potts-Smith, Dressing Forceps	27,28	Retractor, Channel-.....	191,202	Ruskin-Liston, Bone Cutting Forceps.....	118	Scissors, Enterotomy.....	19
Potts-Smith, Vascular Scissors.....	14	Retractor, Cheek-.....	188	Russ. Modell, Dissecting Forceps.....	31	Scissors, Enucleation.....	17
Powder Pot	212	Retractor, Chin.....	191	Rydel-Seiffert, Tuning Fork.....	172	Scissors, Episiotomy,	15
Pratt, Haemostatic Forceps	37	Retractor, External Progeny-	191,192	Ryder (Martin), Needle Holder	86	Scissors, Face-lift.....	11,12,19,23,147
Price-Thomas, Bronchus Clamp	123	Retractor, Extra Oral-.....	189	Ryder-Vascular, Needle Holder.....	86	Scissors, Gum.....	16,25
Probe	168	Retractor, Iliac Crest-.....	205	S		Scissors, Gynecological.....	09
Profunda Clamp	125	Retractor, Internal Progeny.....	191,192	Saalfeld, Comedone Extractor.....	147	Scissors, Hysterectomy,	24,25
Progeny Retractor.....	191	Retractor, Intra Oral-.....	190	Sachs, Dura Dissector.....	41	Scissors, Incision,	07
Prostatic Retractor	156	Retractor, Knee.....	111	Sachs, Dura Hook.....	143	Scissors, Iris,	16,17
Protecting Disc	175	Retractor, Lip & Cheek.....	188,196	Sachse, Gauge	158	Scissors, Micro Dissecting.....	18
Protection Cap	178	Retractor, Mandibular-.....	201	Sachse, Meatotome	158	Scissors, Micro Ear,	169
Protector, Finger.....	186	Retractor, Mandibular Body.....	196	Saddle Hook.....	51,52,53,184	Scissors, Micro,	17,19
Providence-Hospital, Haemostatic Forceps.....	38	Retractor, Mobilizing-.....	208	Saddle Hook	184	Scissors, Micro-, for veins	18
Pterygoid Osteotome.....	196	Retractor, Multi purpose-.....	190	Saddle Hooklet	207	Scissors, Nasal-.....	11,15
Pudendus Anaesthesia Needle.....	78	Retractor, Nasal-	183,184	Safety Pin.....	210	Scissors, Neurosurgical.....	14
Punch, Antrum-	178,179	Retractor, Nasal Spine-.....	201	Salenius, Meniscus Knife.....	111	Scissors, Operating	06,07,09,12,16
Punch, Cranial-.....	140	Retractor, Nerve Root-.....	142	Salyer, Bone Holding Forceps	194	Scissors,	20-21, 22,25
Punch, Dermal.....	147	Retractor, Orbital Rim.....	193	Salyer, Cleft Palate Dissector.....	198	Scissors, Plaster	93,94
Punch, Laminectomy.....	143,144	Retractor, Pelvis.....	63	Salyer, Cleft Palate Elevator	198	Scissors, Rectal-.....	19
Punch, Sphenoid Bone-	179	Retractor, Periform Rim-	196	Salyer, Cleft Palate Hooklet	198	Scissors, Strabismus-	17
Punch, Tonsil-.....	199	Retractor, Progeny-	191	Salyer, Dissecting Scissors	13,19	Scissors, Tendon-	17
Pusher, Wire-.....	192	Retractor, Prostatic.....	156	Sänger, Placenta & Ovum Forceps.....	167	Scissors, TMJ Disc	194
Putti, Bone Rasp.....	102	Retractor, Ramus-	201,208	Santulli, Bulldog Clamp	124	Scissors, Tonsil-.....	15,25
		Retractor, Rib-	183,184,122	Sanvenero, Operating Scissors	12	Scissors, Trigeminal.....	14
		Retractor, Scapula.....	60	Sarot, Dissecting & Ligature Forceps	41	Scissors, Umbilical.....	16
		Retractor, Soft Tissue-	190,201	Sarot, Needle Holder	85	Scissors, Undermining.....	207



Alphabetical Index

Scissors, Uterine.....	23,24	Smithwick, Nerve Hook.....	142	Stille-Ruskin, Bone Rongeur.....	117	Tessier, Wire Cutting Scissors	207
Scissors, Vascular.....	13,14	Snare Wire.....	173, 176, 199	Stille-Sherman, Hand Drill	96	T-Handle	182
Scissors, Wire Cutting.....	207	Snare, Polypus.....	173, 176	Stockmann, Penis Clamp	158	Third Molar Retractor.....	201
Scoop, Ear.....	174	Snare, Tonsil.....	199	Stomach and Intestinal Anastomosis		Thoms-Allis, Intestinal & Tissue	
Scoop, Gall Stone.....	156	Snyder-O.S.U, Bone Chisel.....	99	Twin Clamp.....	150	Grasping Forceps	148
Scoop, Placenta.....	167	Socket Joint.....	74	Stone, Sharpening.....	05	Thoms-Gaylor, Uterine Biopsy Forceps.....	165
Scoop, Uterine.....	166	Soft Tissue Retractor	190, 201,206	Storage Case.....	209	Thoracic Retractor.....	123
Scoop/Hook, Ear	174	Somer, Uterine Seizing Forceps	164	Storage Rack for Petri Dishes	209	Thoracic Retractor.....	205
Scoville, Bone Curette	105	Sound, Urethral.....	158	Storage Rack, Ear Specula.....	171	Thorek, Dissecting Scissors	11
Scoville, Nerve Root Retractor	142	Sound, Uterine.....	162	Storing Rack for Bed Pans	214	Threaded Tip.....	175
Scraper, Lupus.....	147	Spare Blade.....	05, 93, 123, 147	Strabismus Scissors	17	Thyroid and Vaginal Retractor	69
Screw, Myoma.....	164	Spare Facings	104,105	Strandell-Stille, Hooklet.....	53	Tieck-Halle, Nasal Speculum.....	175
Screwdriver.....	96	Spare Needle	89	Stratte, Needle Holder	83,87	Tier, Knot.....	90
Screwdriver Bit	96	Spare part Set.....	98	Strauss, Penis Clamp.....	158	Tip, button ended.....	175
Scudder, Intestinal Clamp.....	152	Spare Pin	140	Stripper, Anterior Border.....	196	Tip, Conical.....	175
Sedillot, Periosteal Elevator.....	107	Spare Saw Blade.....	95	Stripper, Tendon.....	112,109	Tip, Suction.....	76,77
Segond, Myoma Knife	164	Spatula	206	Strully, Neurosurgical Scissors.....	14	Tip, Threaded.....	175
Seiffert, Exchangeable Tip.....	200	Spatula, Abdominal.....	64	Strümpel, Ear Polypus Forceps	173	TMJ Condyle Hook.....	194
Sellheim, Obstetrical Lever	167	Spatula, Brain.....	142	Struycken, Nasal Cutting Forceps	178	TMJ Disc Forceps.....	194
Sellors, Rib Contractor.....	123	Spatula, Fasciotomy.....	138	Subramanian, Aortic Clamp.....	139	TMJ Disc Scissors.....	194
Semb, Bone Cutting Forceps	119	Spatula, Intima.....	138	Subramanian-Miniature, Aortic Clamp.....	139	TMJ-Elevator.....	194
Semb, Bone Holding Forceps	114	Spatula, Lung.....	123	Suction Cannula	76	TMJ-Forceps	195
Semb, Bone Rongeur	117	Spatula, Tongue Spatula.....	189	Suction Curette.....	164,166	TMJ-Rasp	194
Semb, Bronchus Clamp	123	Specimen Loop	213	Suction Handle	77	TMJ-Spreader	194,195
Semb, Periosteal Elevator	108	Specula Blade, only.....	161	Suction Nozzle.....	175	Tobold, Tongue Depressor.....	188
Semken, Dissecting Forceps.....	28,30	Speculum, Ear.....	171	Suction Raspatory	185	Toennis, Dura Dissector	141
Semken, Dressing Forceps	26	Speculum, Endocervical.....	161	Suction Tip	76,77	Toennis, Needle Holder.....	83,88
Semm, Vaginal Speculum	159	Speculum, Nasal.....	175,176,204	Suction Tube	76,78	Toennis-Adson TCC-BlackLine	
Senn-Green, Hooklet	52	Speculum, Rectal.....	153	Surgical Needle	80	Toennis-Adson, Dissecting Scissors	14,23
Senn-Miller, Hooklet	52	Speculum, Vaginal.....	159	Suture Set	90,91	Toennis-Adson-Aquila, Dissecting Scissors.....	20
Septonasal Osteotome	202,207	Spencer, Stitch Scissors	19	Swallowtail Raspatory	202	Tohoku, Towel Clamp	48
Septum Chisel	181	Spencer-Wells, Haemostatic Forceps	36	Swivel headed scalpel handle	02	Tong, Skull Traction.....	140
Septum Elevator	180	Sphenoid Bone Punch	179	Swivel Knife	180	Tongue Depressor	187,188
Septum Forceps	177,178,184	Spherical Burr	96	Syringe.....	175	Tongue Holding Forceps.....	189
Septum Gouge	191	Sphincteroscope	154	Syringe Rack.....	212	Tongue Spatula	189
Septum Knife	180	Spinal Retractor	111	Syringe, Ear.....	175	Tonsil Dissector/Retractor.....	198
Septum Morselizer	178,179	Spirit Lamp	213	T		Tonsil Elevator	198
Septum Straightening Forceps.....	184	Splinter Forceps.....	33,34	Tabb, Mucosa Knife.....	170	Tonsil Forceps.....	199
Set, Laryngoscope.....	79	Sponge Forceps	49,50	Tablet Tray.....	212	Tonsil Grasping Forceps	199
Set, Small Suture.....	89,91	Spongiosa Gouge	100	Takahashi, Ethmoid Bone Forceps.....	177	Tonsil Knife	198
Set, Spare part.....	98	Spoon, Medicine	212	Tamper.....	103	Tonsil Knife / Enucleator	198
Set, Suture.....	89,91	Spraeder, Plaster.....	94	Tangential Forceps	44	Tonsil Needle.....	78
Set, Venae sectio.....	91	Spratt, Bone Curette.....	105	Tangential Occlusion Clamp	132	Tonsil Punch.....	199
Shaaf, Splinter Forceps.....	33	Spreader, Bladder Neck.....	157	Tantalum Wire.....	98	Tonsil Scissors.....	15,25
Shambaugh, Micro Ear Hook	171	Spreader, Fat.....	65	Tape, Silicone	209	Tonsil Snare.....	199
Shapleigh, Ear Curette.....	174	Spreader, Lamina.....	143	Taylor, Dissecting Forceps	30	Tourniquet	138
Sharpening Stone.....	05	Spreader, Rectal.....	153	Taylor, Dressing Forceps.....	26,27	Towel Clamp	47,48
Shea Vein Graft, Dissecting Scissors	12	Spreader, TMJ.....	195	Taylor, Mod. USA, Percussion Hammer.....	73	Toynbee, Ear Specula, Set.....	171
Shea, Exploring Hook	171	Spreaders, Wound, self-retaining	65,69	Taylor, Spinal Retractor	111	Toynbee, Ear Speculum	171
Shea, Multi purpose Retractor	190	Spreading Forceps.....	207	Teale, Uterine Tenaculum Forceps.....	163	Tracheal Dilator.....	145
Shear, Bone.....	120	Spurling, Laminectomy Rongeur	145	Template, Frontal.....	208	Tracheal Hook	145,146
Shear, Rib	120	Sputum Cup	212	Tendon Holding Forceps.....	112	Travers, Wound Spreaders, self-retaining.....	66
Shears, Plaster.....	93,94	St. Marks, Pelvis Retractor	63	Tendon Interlacing Forceps	112	Trax, Instrument.....	211
Sickle Knife.....	170	Stainless Steel Bowl	211	Tendon Passer.....	112	Tray, Tablet.....	212
Sigmoid Anastomosis Forceps	152,153	Stand, Infusion.....	213	Tendon Passing Instrument	112	Tray, Universal.....	211
Silicone Inlay.....	187	Stand, Wash Basin.....	214	Tendon Scissors	17	Trelat, Vaginal Speculum.....	159
Silicone Tape	209	ST Clair-Thomson	185	Tendon Stripper	112	Triangular Basin	212
Silver, Dermatome	05	Steinberg, Elevator	208	Tendon Tunnelling Forceps	112	Trigeminal Scissors.....	14
Silver, Rhinoplastic Chisel.....	182	Steinberg, Ramus Retractor.....	208	Terry, Duct Retractor.....	113	Trocar.....	206
Simon, Bone Curette	106	Steinhäuser, Bone Holding Forceps.....	194	Terry, Elevator	186	Trolley, Bucket.....	214
Simon, Fistula Hook	164	Steinhäuser, Chisel.....	197	Terry, Graft Packer.....	186	Tröltzsch (Wilde), Ear Forceps	173
Simon, Retractor	59	Steinhäuser, Ramus Clamp	197	Tessier, Awl.....	206	Tröltzsch, Nasal Tampon Forceps.....	177
Simon, Uterine Scoop.....	166	Steinhäuser, Ramus Osteotome	197	Tessier, Bone Contouring Forceps.....	206	Trousseau, Tracheal Dilator.....	145
Simpson, Obstetrical Forceps	167	Steinhäuser, Reposition Instrument.....	197	Tessier, Bone Cutting Forceps.....	205	Troutman-Chris, Blade Holder/Blade Breaker.....	02
Sims, Gynecological Scissors.....	09	Steinmann, Tendon Holding Forceps	112	Tessier, Bone Holding Forceps	205	Trowel Knife.....	168
Sims, Rectal Speculum.....	153	Stella-S, Face-lift Scissors	147	Tessier, Bone Hook	207	Tubal Forceps	32
Sims, Uterine Curette	166	Stellbrink, Bone Rongeur	115	Tessier, Caliper.....	207	Tube, flexible.....	175
Sims, Uterine Scissors.....	24	Step.....	214	Tessier, Disimpaction Forceps.....	207	Tube, Interchangeable.....	199
Sims, Uterine Sound	162	Sterilizing Forceps.....	209	Tessier, Dissecting Scissors	207	Tube, Laryngeal.....	199
Sims, Vaginal Speculum	159	Sternal Retractor	121	Tessier, Iliac Crest Retractor	205	Tube, Suction.....	76,78
Sims-Aquila, Uterine Scissors.....	23	Sternberg, Lip & Cheek Retractor.....	88	Tessier, Maxillary Mobilizer.....	193	Tuberosity Osteotome.....	203
Sims-Siebold, Gynecological Scissors.....	09	Stethoscope.....	73	Tessier, Mobilizing Retractor.....	208	Tuffier, Haemostatic Forceps	37
Singley-Tuttle, Dissecting Forceps.....	32	Stevens, Tendon Scissors	17	Tessier, Nasal Speculum	204	Tuffier, Rib Retractor	122
Sinus Forceps	49	Stieglitz, Splinter Forceps	34	Tessier, Osteotome	204,205,207	Tumor Grasping Forceps.....	37,145
Skene, Uterine Tenaculum Forceps	163	Stille, Bone Rongeur.....	117	Tessier, Periosteal Elevator	206	Tuning Fork	172
Skin Fixing Plate	05	Stille, Chisel	100	Tessier, Saddle Hooklet.....	207	Tunneling Forceps	49
Skin Grasping Forceps	184	Stille, Dissecting Forceps.....	30	Tessier, Scalp Clamp.....	204	Tuohy, Lumbar Puncture Needle	78
Skin Hook	51	Stille, Dressing Forceps	26	Tessier, Septonasal Osteotome.....	207	Twin Clamp, Stomach & Intestinal	
Skin Hooklet	204	Stille, Gouge.....	100	Tessier, Skin Hooklet	204	Anastomosis.....	150
Skull Breaker	99	Stille, Hand Drill	96	Tessier, Soft Tissue Retractor.....	206	Twist Drill	96
Skull Traction Tong.....	140	Stille, Osteotome.....	100	Tessier, Spatula.....	206	Tyding, Tonsil Snare.....	199
Small Suture Set.....	90,91	Stille-Barraya, Dissecting Forceps	31	Tessier, Spreading Forceps	207	Tympanum Lancet	174
Smillie, Meniscus Knife	111	Stille-Liston, Bone Cutting Forceps	118,119	Tessier, Thoracic Retractor	205	Tympanum Needle.....	174
Smith-Petersen, Gouge	102	Stille-Luer, Bone Rongeur	117	Tessier, Trocar	206		
Smith-Petersen, Osteotome	101	Stille-Martin, Plaster Shears.....	93	Tessier, Undermining Scissors	207		



Alphabetical Index

U

Ulrich, Bone Holding Forceps	114
Ulrich, Dressing Forceps	49
Umbilical Cord Clamp.....	167
Umbilical Scissors.....	16
Undermining Scissors	207
Universal Handle.....	199
Universal Tray	211
Universal, Bandage Scissors.....	93
Universal, Trocar	76
Universal, Wire Cutting Scissors	20,25
Unna, Comedone Extractor.....	147
Unna-Vidal, Comedone Extractor.....	147
Urethral Sound	158
Urethrography Instrument	158
Urinal Rack	214
Uro-Tangential, Tangential Forceps.....	44
Uterine Biopsy Curette.....	164
Uterine Biopsy Forceps	165
Uterine Clamp.....	167
Uterine Curette	166
Uterine Depressor.....	162
Uterine Dilator	161,162
Uterine Dilators, Set.....	161,162
Uterine Polypus Forceps	163
Uterine Scissors.....	23
Uterine Scoop.....	166
Uterine Seizing Forceps	164
Uterine Sound.....	162
Uterine Tenaculum Forceps.....	162,163
V	
Vaginal Clamp.....	46
Vaginal Retractor.....	159
Vaginal Speculum	159
Valleix, Uterine Sound	162
Valve Attachment	175
Van Buren, Urethral Sound.....	158
Van Doren, Uterine Biopsy Forceps	165
Vascular Clamp	42,132
Vascular Dilator.....	138
Vascular Dissector	138
Vascular Forceps	128,136
Vascular Measuring Caliper	127
Vascular Scissors.....	13,14
Veidenheimer, Sigmoid Anastomosis Forceps	152
Vein Cannula	78
Vein Hook.....	53
Velcro Cuff.....	75
Venae sectio Set.....	91
Verbrugge, Bone Holding Forceps	115
Verres, Insufflation Cannula	78
Vessel Clip.....	35
Vessel Hook	51
Vessel Irrigation Cannula.....	78
Vestibulum Retractor	188
Vickers, Dissector	109
Vickers, Elevator.....	109
Vickers, Hand Restrainer.....	119
Vickers, Mallet	105
Vidal, Lupus Scraper	147
Virchow, Brain Knife	01
Virchow, Skull Breaker	99
Vise Grip	97
Volkman, Bone Curette	105
Volkman, Bone Curette, double-ended	106
Volkman, Retractor.....	54
Vollmar, Vessel Irrigation Cannula	78
W	
Wachenfeldt, Clip Applying Forceps	90
Wagener, Ear Hooklet.....	174
Wagner, Operating Scissors	16
Walb, Post Mortem Knife	01
Waldmann, Episiotomy Scissors.....	15
Walter, Chisel.....	181
Walter, Osteotome	181
Wangensteen, Dressing Forceps	29
Wangensteen, Needle Holder.....	83,86
Wash Basin Stand	214
Wassmund, Retractor.....	55
Waste Bucket.....	214
Waste Cotton Collector	212
Waste Forceps.....	214
Watson-Williams, Ethmoid Bone Forceps	177
Waugh, Dissecting Forceps.....	30
Waugh, Dressing Forceps	26
Weber, Aortic Clamp	131
Weber-Loch, Foreign Body Instrument	174
Webster, Needle Holder	82,84,85
Wedge Osteotome.....	203
Weight for Vaginal Speculum.....	161
Weil, Ethmoid Bone Forceps.....	177
Weil-Blakesley, Ethmoid Bone Forceps	178
Weil-Blakesley, Nasal Cutting Forceps	178
Weitlaner, Wound Spreaders self-retaining	66,67
Weitlaner-Baby, Wound Spreaders self-retaining	67
Weitlaner-Wullstein, Wound Spreaders self-retaining	67
Wertheim, Gynecological Scissors	09
Wertheim, Hysterectomy Forceps	47
Wertheim-Cullen, Vaginal Clamp	46
Westcott, Strabismus Scissors	17
Westmacott, Nasal Tampon Forceps	177
White, Tonsil Grasping Forceps	199
Wick	213
Wieder, Tongue Depressor	188
Wikstroem, Dissecting & Ligature Forceps.....	44
Williams, Intestinal & Tissue. Grasping Forceps	148
Williger, Bone Curette, double-ended	106
Williger, Elevator	109
Williger, Mallet.....	103,104
Williger, Periosteal Elevator	108
Winter, Placenta & Ovum Forceps	167
Wire Bending Forceps	170
Wire Catching Forceps	38
Wire Cutter	98
Wire Cutter, front action.....	98
Wire Cutting Pliers	98
Wire Cutting Scissors.....	20,25,207
Wire Loop	199
Wire Pincer.....	204
Wire Pusher	192
Wire Saw	140
Wire Saw Guide.....	140
Wire Saw Handle.....	140
Wire Twisting Forceps	97,204
Wire, Bone-	98
Wire, Snare.....	173,176,119
Wire, Tantalum-.....	98
Wolff, Lupus Curette.....	147
Wolff, Plaster Breaker	94
Wound Spreaders, self-retaining	65,69
Wrigley, Obstetrical Forceps	167
Wullstein, Micro Ear Scissors.....	169
Wullstein, Sickle Knife.....	170
Wullstein, Suction Tube	76
Wylie, Aorta-Anastomosis Clamp	131
Wylie, Aortic Clamp	126
Y	
Yankauer, Handle	77
Yankauer, Olive	77
Yankauer, Suction Tip	77
Yankauer, Suction Tube.....	77
Yasargil, Galea hook	141
Yasargil, Pituitary Rongeur	145
Yasargil, Suction Tube.....	77
Young, Needle Holder	89
Young, Prostatic Retractor	156
Young, Rubber Insert	189
Young, Spare Needle	89
Young, Tongue Holding Forceps	189
Z	
Zaufal, Foreign Body Lever	174
Zaufal-Jansen, Bone Rongeur	116
Zenker, Dissecting & Ligature Forceps	43
Zenker, Retractor.....	57
Ziegler, Head Mirror.....	58
Ziegler, Mirror	58
Zöllner, Ear Specula, Set.....	171
Zöllner, Ear Speculum	171
Zöllner, Suction Tips	63
Zöllner, Suction Tube, only	63
Zweifel, Needle Holder	88
Zygoma Elevator.....	193
Zygomatic Arch Awl	203



Airport Road, Gohad Pur, Sialkot 51360 - Pakistan
Tel: +92-52-4261591 Fax: +92-52-4261575
Cell: +92-300-7153929 Cell: +92-3009615541
E-mail: sales@paramountsurgical.net
info@paramountsurgical.net
Web: www.paramountsurgical.net



CE ISO-9001-2008